Digital Controller

FB400/FB900

Instruction Manual

- Modbus is a registered trademark of Schneider Electric.
- Company names and product names used in this manual are the trademarks or registered trademarks of the respective companies.

Thank you for purchasing this RKC product. In order to achieve maximum performance and ensure proper operation of your new instrument, carefully read all the instructions in this manual. Please place the manual in a convenient location for easy reference.

NOTICE

- This manual assumes that the reader has a fundamental knowledge of the principles of electricity, process control, computer technology and communications.
- The figures, diagrams and numeric values used in this manual are only for purpose of illustration.
- RKC is not responsible for any damage or injury that is caused as a result of using this instrument, instrument failure or indirect damage.
- RKC is not responsible for any damage and/or injury resulting from the use of instruments made by imitating this instrument.
- Periodic maintenance is required for safe and proper operation of this instrument. Some components have a limited service life, or characteristics that change over time.
- Every effort has been made to ensure accuracy of all information contained herein. RKC makes no warranty expressed or implied, with respect to the accuracy of the information. The information in this manual is subject to change without prior notice.
- No portion of this document may be reprinted, modified, copied, transmitted, digitized, stored, processed or retrieved through any mechanical, electronic, optical or other means without prior written approval from RKC.



WARNING

- An external protection device must be installed if failure of this instrument could result in damage to the instrument, equipment or injury to personnel.
- All wiring must be completed before power is turned on to prevent electric shock, fire or damage to instrument and equipment.
- This instrument must be used in accordance with the specifications to prevent fire or damage to instrument and equipment.
- This instrument is not intended for use in locations subject to flammable or explosive gases.
- Do not touch high-voltage connections such as power supply terminals, etc. to avoid electric shock.
- RKC is not responsible if this instrument is repaired, modified or disassembled by other than factory-approved personnel. Malfunction can occur and warranty is void under these conditions.

CAUTION

- This product is intended for use with industrial machines, test and measuring equipment. (It is not designed for use with medical equipment and nuclear energy.)
- This is a Class A instrument. In a domestic environment, this instrument may cause radio interference, in which case the user may be required to take additional measures.
- This instrument is protected from electric shock by reinforced insulation. Provide reinforced insulation between the wire for the input signal and the wires for instrument power supply, source of power and loads.
- Be sure to provide an appropriate surge control circuit respectively for the following:
 - If input/output or signal lines within the building are longer than 30 meters.
 - If input/output or signal lines leave the building, regardless the length.
- This instrument is designed for installation in an enclosed instrumentation panel. All high-voltage connections such as power supply terminals must be enclosed in the instrumentation panel to avoid electric shock by operating personnel.
- All precautions described in this manual should be taken to avoid damage to the instrument or equipment.
- All wiring must be in accordance with local codes and regulations.
- All wiring must be completed before power is turned on to prevent electric shock, instrument failure, or incorrect action.

The power must be turned off before repairing work for input break and output failure including replacement of sensor, contactor or SSR, and all wiring must be completed before power is turned on again.
- To prevent instrument damage or failure, protect the power line and the input/output lines from high currents with a protection device such as fuse, circuit breaker, etc.
- Prevent metal fragments or lead wire scraps from falling inside instrument case to avoid electric shock, fire or malfunction.
- Tighten each terminal screw to the specified torque found in the manual to avoid electric shock, fire or malfunction.
- For proper operation of this instrument, provide adequate ventilation for heat dispensation.
- Do not connect wires to unused terminals as this will interfere with proper operation of the instrument.
- Turn off the power supply before cleaning the instrument.
- Do not use a volatile solvent such as paint thinner to clean the instrument. Deformation or discoloration will occur. Use a soft, dry cloth to remove stains from the instrument.
- To avoid damage to instrument display, do not rub with an abrasive material or push front panel with a hard object.
- Do not connect modular connectors to telephone line.
- When high alarm with hold action/re-hold action is used for Event function, alarm does not turn on while hold action is in operation. Take measures to prevent overheating which may occur if the control device fails.

FOR PROPER DISPOSAL

- When disposing of each part used for this instrument, always follows the procedure for disposing of industrial wastes stipulated by the respective local community.

SYMBOLS

Safety Symbols:

WARNING : This mark indicates precautions that must be taken if there is danger of electric shock, fire, etc., which could result in loss of life or injury.

CAUTION : This mark indicates that if these precautions and operating procedures are not taken, damage to the instrument may result.



: This mark indicates that all precautions should be taken for safe usage.



: This mark indicates important information on installation, handling and operating procedures.



: This mark indicates supplemental information on installation, handling and operating procedures.



: This mark indicates where additional information may be located.

Character Symbols:

0	1	2	3	4	5	6	7	8	9	Minus	Period
0	1	2	3	4	5	6	7	8	9	-	.
A	B (b)	C	c	D (d)	E	F	G	H	I	J	K
A	b	C	c	d	E	F	G	H	I	J	K
L	M	N (n)	O (o)	P	Q (q)	R (r)	S	T	t	U	u
L	n	n	o	P	q	r	S	T	t	U	u
V	W	X	Y	Z	Degree	/	Dash				
V	W	X	Y	Z	°	/	-	'			

	Dim lighting
	Bright lighting
	Flashing

DOCUMENT CONFIGURATION

There are six manuals pertaining to this product. Please be sure to read all manuals specific to your application requirements. If you do not have a necessary manual, please contact RKC sales office, the agent, or download from the official RKC website.

The following manuals can be downloaded from the official RKC website:

http://www.rkcinst.com/english/manual_load.htm.

Manual	Manual Number	Remarks
FB400/FB900 Installation Manual	IMR01W01-E□	This manual is enclosed with instrument. This manual explains the mounting and wiring, front panel name, and the operation mode outline.
FB400/FB900 Quick Operation Manual	IMR01W02-E□	This manual is enclosed with instrument. This manual explains the basic key operation, mode menu, and data setting.
FB400/FB900 Parameter List	IMR01W06-E□	This manual is enclosed with instrument. This list is a compilation of the parameter data of each mode.
FB400/FB900 Communication Quick Manual	IMR01W07-E□	A product box contains this manual. (Only FB400/900 provided with the communication function) This manual explains the connection method with host computer, communication parameters, and communication data (except for parameters in Engineering Mode).
FB400/FB900 Instruction Manual	IMR01W03-E7	This Manual. This manual explains the method of the mounting and wiring, the operation of various functions, and troubleshooting.
FB100/FB400/FB900 Communication Instruction Manual *	IMR01W04-E□	This manual explains RKC communication protocol (ANSI X3.28-1976), Modbus, and relating to the communication parameters setting.

* Sold separately



Read this manual carefully before operating the instrument. Please place this manual in a convenient location for easy reference.

CONTENTS

	Page
1. OUTLINE	1-1
1.1 Features	1-2
1.2 Checking the Product	1-3
1.3 Model Code	1-4
■ Suffix code.....	1-4
■ Quick start code 2 (Initial setting code)	1-6
1.4 Parts Description	1-7
1.5 Input/Output Functions	1-11
2. HANDLING PROCEDURE TO OPERATION	2-1
3. MOUNTING	3-1
3.1 Mounting Cautions.....	3-2
3.2 Dimensions.....	3-3
■ FB400.....	3-3
■ FB900.....	3-3
3.3 Procedures of Mounting and Removing	3-4
■ Mounting procedures.....	3-4
■ Removing procedures	3-4
4. WIRING	4-1
4.1 Wiring Cautions	4-2
4.2 Terminal Layout.....	4-5
■ FB400.....	4-5
■ FB900.....	4-5
■ Isolations of input and output (common to FB400/900).....	4-6
4.3 Wiring of Each Terminal	4-7
■ Power supply	4-7
■ Output 1 (OUT1)/Output 2 (OUT2)	4-8
■ Digital output 1 to 4 (DO1 to DO4) [optional].....	4-9
■ Transmission output (AO) [optional].....	4-10
■ Measured input (Thermocouple/RTD/Voltage/Current) [universal input].....	4-10
■ Remote setting (RS) input [universal input].....	4-11
■ Digital input (DI1 to DI4 [optional], DI5 to DI7 [standard])	4-11
■ Current transformer (CT) input/Power feed forward (PFF) input/ Feedback resistance (FBR) input [optional].....	4-12
■ Communication 1/Communication 2 [optional].....	4-12

	Page
4.4 Handling of the Terminal Cover [optional]	4-15
■ Mounting procedures.....	4-15
■ Removing procedures	4-16

5. OPERATION MENU AND BASIC OPERATION5-1

5.1 Operation Menu	5-2
■ Input type and input range display.....	5-3
5.2 Basic Operation	5-4
5.2.1 Scrolling through parameters	5-4
■ SV setting & monitor mode	5-4
■ Parameter setting mode, Setup setting mode	5-5
■ Operation mode	5-6
■ Engineering mode.....	5-7
5.2.2 Changing Set value (SV).....	5-8
5.2.3 Operation of the direct keys	5-9
5.2.4 Data lock function.....	5-10

6. OPERATION6-1

6.1 Operating Precautions	6-2
6.2 Monitoring Display in Operation.....	6-3
■ Direct key type 1	6-3
■ Direct key type 2.....	6-4
6.3 Operating Setting.....	6-5
6.3.1 Set the Set value (SV).....	6-5
6.3.2 Set the Event set value (alarm set value)	6-6
6.3.3 Autotuning (AT) start.....	6-8
■ To manually set PID values	6-9
6.4 RUN/STOP Transfer.....	6-11
■ RUN/STOP transfer by Front key operation	6-11
■ RUN/STOP transfer by Direct key (R/S) operation.....	6-12
■ RUN/STOP transfer by Digital input (DI)	6-13
6.5 Autotuning (AT)	6-15
■ Caution for using the Autotuning (AT)	6-15
■ Requirements for Autotuning (AT) start.....	6-15
■ Requirements for Autotuning (AT) cancellation.....	6-15
■ Autotuning (AT) start/stop operation.....	6-16
6.6 Startup Tuning (ST)	6-18
■ Caution for using the Startup tuning (ST)	6-18
■ Requirements for Startup tuning (ST) start.....	6-19

	Page
■ Requirements for Startup tuning (ST) cancellation.....	6-19
■ Startup tuning (ST) setting.....	6-20
6.7 Auto/Manual Transfer	6-23
■ Auto/Manual transfer by Front key operation	6-24
■ Auto/Manual transfer by Ddirect key (A/M) operation.....	6-25
■ Auto/Manual transfer by Digital input (DI).....	6-26
■ Procedure for setting the Manipulated output value (MV) in Manual mode.....	6-27
6.8 Remote/Local Transfer	6-28
■ Remote/Local transfer by Front key operation	6-28
■ Remote/Local transfer by Direct key (R/L) operation	6-29
■ Remote/Local transfer by Digital input (DI).....	6-30
6.9 Control Area Transfer	6-32
■ Control area transfer by Front key operation.....	6-33
■ Control area transfer by Direct key (AREA) operation.....	6-34
■ Control area transfer by Digital input (DI) [optional]	6-35
■ Control area transfer by Area soak time (Ramp/Soak Control)	6-35
6.10 Interlock Release.....	6-36
■ Interlock release method by Front key operation	6-37
■ Interlock release method by Digital input (DI).....	6-38
6.11 Start Action at Recovering Power Failure	6-39
■ Hot/Cold start selection	6-39
■ Start determination point	6-39
6.12 Position Proportioning PID Control.....	6-40
■ Setting flowchart.....	6-42
■ Setting procedures	6-44
6.13 Ramp/Soak Control	6-50
■ Operation flowchart	6-51
■ Settings before operation	6-52
■ Operation procedures.....	6-55
6.14 Group Operation by the Intercontroller Communication	6-60
6.14.1 Wiring method of the Intercontroller communication.....	6-60
6.14.2 Common setting of the Intercontroller communication.....	6-61
6.14.3 Group RUN/STOP function	6-63
■ Operation flowchart.....	6-63
■ Requirements for Group RUN/STOP.....	6-64
■ Group RUN/STOP operation and states.....	6-64
■ Settings before operation.....	6-65
■ Usage example.....	6-69
6.14.4 Automatic temperature rise function (with learning function)	6-72
■ Requirements for automatic temperature rise learning start.....	6-73
■ Requirements for automatic temperature rise learning cancellation.....	6-73

	Page
■ Requirements for automatic temperature rise start	6-74
■ Requirements for automatic temperature rise cancellation	6-74
■ Operation flowchart.....	6-75
■ Settings before operation.....	6-76
■ Operation procedures	6-80
6.14.5 Cascade control function.....	6-82
■ Operation flowchart.....	6-83
■ Settings before operation.....	6-84
■ Adjustment after control starting	6-87
■ Operation procedures	6-90
6.14.6 Ratio setting function.....	6-91
■ Operation flowchart.....	6-92
■ Settings before operation.....	6-93
■ Adjustment after control starting	6-96
■ Operation procedures	6-99
■ Usage example.....	6-100

7. DESCRIPTION OF EACH PARAMETER..... 7-1

7.1 SV Setting & Monitor Mode.....	7-2
7.1.1 Display sequence (When the Direct key type is Type 1).....	7-2
7.1.2 Display sequence (When the Direct key type is Type 2).....	7-3
7.1.3 Monitor and setting item.....	7-4
7.2 Operation Mode.....	7-14
7.2.1 Display sequence.....	7-14
7.2.2 Operation item.....	7-15
7.3 Parameter Setting Mode.....	7-19
7.3.1 Display sequence.....	7-20
7.3.2 Parameter setting item	7-21
7.4 Setup Setting Mode.....	7-34
7.4.1 Display sequence.....	7-34
7.4.2 Setup setting item	7-35
7.5 Engineering Mode	7-48
7.5.1 Display sequence.....	7-48
7.5.2 Precaution against parameter change	7-55
7.5.3 Engineering setting item.....	7-62
Function block 10 (F10.) [Display].....	7-62
Function block 11 (F11.) [Direct key].....	7-67
Function block 21 (F21.) [Input].....	7-69
Function block 22 (F22.) [Remote setting input type].....	7-77
Function block 23 (F23.) [Digital input assignment]	7-78

	Page
Function block 30 (F30.) [Output].....	7-79
Function block 33 (F33.) [Transmission output]	7-83
Function block 41 (F41.) [Event 1]	7-85
Function block 42 (F42.) [Event 2]	7-95
Function block 43 (F43.) [Event 3]	7-102
Function block 44 (F44.) [Event 4]	7-109
Function block 45 (F45.) [Heater break alarm 1].....	7-116
Function block 46 (F46.) [Heater break alarm 2].....	7-120
Function block 50 (F50.) [Hot/Cold start etc.].....	7-123
Function block 51 (F51.) [Control 1]	7-129
Function block 52 (F52.) [Control 2]	7-146
Function block 53 (F53.) [Position proportioning PID control]	7-158
Function block 54 (F54.) [Startup tuning]	7-163
Function block 55 (F55.) [Group/Automatic temperature rise]	7-165
Function block 60 (F60.) [Communication protocol].....	7-168
Function block 70 (F70.) [Time unit].....	7-169
Function block 71 (F71.) [Setting limiter].....	7-170
Function block 91 (F91.) [Others].....	7-171

8. TROUBLESHOOTING8-1

8.1 Error Display.....	8-2
■ Display when input error occurs	8-2
■ Self-diagnostic error	8-3
8.2 Solutions for Problems	8-4
■ Display.....	8-5
■ Control.....	8-6
■ Operation.....	8-8
■ Event function.....	8-9
■ Heater break alarm (HBA).....	8-10

9. SPECIFICATIONS9-1

■ Measured input.....	9-2
■ Remote setting (RS) input	9-3
■ Current transformer (CT) input [optional].....	9-4
■ Feedback resistance (FBR) input [optional].....	9-4
■ Power feed forward (PFF) input [optional].....	9-4
■ Digital input (DI)	9-4
■ Output (OUT1, OUT2)	9-5
■ Digital output (DO1 to DO4) [optional].....	9-6
■ Transmission output (AO) [optional]	9-6

	Page
■ Performance (at the ambient temperature 23 ±2 °C).....	9-7
■ Control	9-8
■ Brilliant II PID control	9-8
■ Brilliant II Heat/Cool PID control	9-9
■ Position proportioning PID control without FBR.....	9-10
■ Event function [optional]	9-11
■ Control loop break alarm (LBA) [optional].....	9-12
■ Power feed forward (PFF) function [optional]	9-12
■ Heater break alarm (HBA) [time-proportional control output (optional)]	9-12
■ Heater break alarm (HBA) [continuous control output (optional)]	9-12
■ Multi-memory area function [optional].....	9-12
■ Loader communication	9-13
■ Communication [optional]	9-13
■ Intercontroller communication function [optional]	9-14
■ Self-diagnostic function.....	9-15
■ Power.....	9-15
■ General specifications	9-16
■ Standard	9-17

APPENDIX A-1

A. Removing the Internal Assembly.....	A-2
B. Replacing the Waterproof/Dustproof Rubber Packing.....	A-4
C. Transformer Dimensions for Power Feed Forward	A-6
D. Current Transformer (CT) Dimensions.....	A-7
E. Memory Area Data List	A-8
F. Parameter List.....	A-9
G. Seal [for Unit and Direct key type 2] (accessory attached)	A-25

INDEX..... B-1

Alphabetical Order.....	B-1
Character Order.....	B-4

Revisions

OUTLINE



1.1 Features	1-2
1.2 Checking the Product	1-3
1.3 Model Code	1-4
1.4 Parts Description	1-7
1.5 Input/Output Functions	1-11

1.1 Features

This chapter describes features, package contents and model code, etc. The digital controller of this high performance type has the following features:

■ **Panel space saving: 60 mm depth**

■ **Selectable sampling time among 50ms, 100ms, and 250 ms.**

Selectable sampling time makes the FB Series suitable for any application ranging from pressure control requiring fast response to precise control requiring highest resolution. (Factory setting: 100 ms)

■ **Selectable PID control algorithm**

PID control algorithm is selectable in the FB Series to achieve the most precise control for various applications.

PV derivative PID: suitable for fixed setpoint control (Factory setting)

Deviation derivative PID: suitable for ramp control using ramp-to-setpoint function and cascade control.

■ **Advanced Heat/Cool PID algorithm with Undershoot Suppression**

■ **Startup tuning to eliminate time for autotuning**

■ **Direct Function Keys**

Three direct function keys enable one-touch operation on frequently used functions such as Auto/Manual, Monitoring display scroll, and Memory area selection. The keys can also be configured as RUN/STOP, Remote/Local, and Auto/Manual keys.

■ **Up to 8 recipes (multi-memory area) or Ramp/Soak control**

FB Series can store up to 8 sets of control parameters. Ramp/Soak control is available by using the memory area function.

■ **Open Network Connectivity**

The FB Series can be connected to various Open Networks, such as PROFIBUS, DeviceNet, CC-Link, and Ethernet via a gateway, by using our COM-J Series.

■ **Easy maintenance**

The internal assembly of the FB Series can be removed from the front.

■ **NEMA4X and IP66 waterproof and dustproof protection for severe environments. (standard)**

■ **Two communication ports (optional)**

- Host communication:

The FB Series has a first communication port (COM1) to communicate (Host communication) with a computer or operation panel for Host communication.

- Intercontroller communication:

The FB Series has a second communication port (COM2) for Intercontroller communication. It achieves more precise cascade control and ratio control by sending data via digital communication while conventional cascade controllers send data to slave controllers by analog signal with less resolution.

■ **Easy-setup and Data Monitoring via a standard data port**

The FB Series has the loader port (provided as standard) to connect to a PC USB port with Windows 2000/XP/Vista/7. The standard port allows setup and data logging to be managed by the PC. The FB Series is recognized as an external device on the PC.

[The communication tool (WinUCI, PROTEM2) can be downloaded from the RKC official website:

[http://www.rkcinst.com/.](http://www.rkcinst.com/)]

1.2 Checking the Product

Before using this product, check each of the following:

- Model code
- Check that there are no scratches or breakage in external appearance (case, front panel, or terminal, etc.)
- Check that all of the items delivered are complete. (Refer to below)

Accessories	Q'TY	Remarks	
<input type="checkbox"/> Instrument	1	_____	
<input type="checkbox"/> Mounting brackets (with screw)	2	FB900: 4	
<input type="checkbox"/> Seal (SAP-306)	1	_____	
<input type="checkbox"/> Case rubber packing (FB400: KFB400-36<1>, FB900: KFB900-36<1>)	1	For waterproof/dustproof	
<input type="checkbox"/> Installation Manual (IMR01W01-E□)	1	Enclosed with instrument	
<input type="checkbox"/> Quick Operation Manual (IMR01W02-E□)	1	Enclosed with instrument	
<input type="checkbox"/> Parameter List (IMR01W06-E□)	1	Enclosed with instrument	
<input type="checkbox"/> Communication Quick Manual (IMR01W07-E□)	1	Enclosed with instrument (with communication 1 function)	
<input type="checkbox"/> Instruction Manual (IMR01W03-E7)	1	This manual (sold separately)	This manual can be downloaded from the official RKC website: <a href="http://www.rkcinst.com/english/
manual_load.htm">http://www.rkcinst.com/english/ manual_load.htm .
<input type="checkbox"/> Communication Instruction Manual (IMR01W04-E□)	1	Sold separately	
<input type="checkbox"/> Terminal cover (KFB400-58(3))	Depending on the order quantity	Optional (sold separately)	
<input type="checkbox"/> Front cover (FB400: KRB400-36, FB900: KRB900-36)	Depending on the order quantity	Optional (sold separately)	
<input type="checkbox"/> Current transformer (CTL-6-P-N [for 0 to 30 A] or CTL-12-S56-10L-N [for 0 to 100 A])	Depending on the order quantity	Optional (sold separately)	
<input type="checkbox"/> Power feed transformer (PFT-01 [100 to 120 V AC] or PFT-02 [200 to 240 V AC])	1	Optional (When ordered PFF function, this transformer is attached.)	



If any of the products are missing, damaged, or if your manual is incomplete, please contact RKC sales office or the agent.

1.3 Model Code

Check that the product received is correctly specified by referring to the following model code list:
If the product is not identical to the specifications, please contact RKC sales office or the agent.

■ Suffix code

FB400 — □ □ — □ * □ □ □ □ / □ □ — □ □ □ □ / Y
FB900 (1) (2) (3) (4) (5) (6) (7) (8) (9) (10) (11) (12)

Specifications		Suffix code														
		Hardware coding only									Quick start code ¹					
		(1)	(2)	(3)	(4)	(5)	(6)	(7)	(8)	(9)	(10)	(11)	(12)			
Output 1 (OUT1)	Relay contact output	M														
	Voltage pulse output	V														
	Voltage output, Current output (Refer to Output Code Table)	□														
	Triac output	T														
	Open collector output	D														
Output 2 (OUT2)	None	N														
	Relay contact output	M														
	Voltage pulse output	V														
	Voltage output, Current output (Refer to Output Code Table)	□														
	Triac output	T														
Power supply voltage	24 V AC/DC		3													
	100 to 240 V AC		4													
Digital output (DO1 to DO4) [Relay contact output]	None			N												
	DO1 + DO2 + DO3 + DO4			4												
CT input	None				N											
	CT input (2 points)				T											
Power feed forward (PFF) input	PFF input (one 100-120 V AC transformer included)				1											
	PFF input (one 200-240 V AC transformer included)				2											
Feedback resistance input	CT input (1point) + PFF input (one 100-120 V AC transformer included)				3											
	CT input (1point) + PFF input (one 200-240 V AC transformer included)				4											
	Feedback resistance input				F											
Transmission output (AO) ¹	None					N										
	Voltage output, Current output (Refer to Output Code Table)					□										
Communication function ² Digital input (DI1 to DI4)	None						N									
	Communication 1 (RS-232C) + No communication 2						1									
	Communication 1 (RS-422A) + No communication 2							4								
	Communication 1 (RS-485) + No communication 2								5							
	Communication 1 (RS-232C) + Communication 2 (RS-485) ³									W						
	Communication 1 (RS-485) + Communication 2 (RS-485) ³										X					
	No communication 1 + Communication 2 (RS-485) ³											Y				
Digital input (DI1 to DI4) [for Memory area transformer]												D				
Case color	White case										N					
	Black case											A				
Quick start code	No quick start code (Configured at factory set value)											N				
	Specify quick start code 1												1			
	Specify quick start code 1 and 2 (Refer to page 1-6)													2		
Control Method [Quick start code 1]	No specify quick start code													No code		
	PID control with AT (Reverse action)													F		
	PID control with AT (Direct action)													D		
	Heat/Cool PID control with AT													G		
	Heat/Cool PID control with AT (for Extruder [air cooling])														A	
	Heat/Cool PID control with AT (for Extruder [water cooling])														W	
	Position proportioning PID control without FBR (Reverse action)														Z	
Position proportioning PID control without FBR (Direct action)														C		
Measured input and Range [Quick start code 1]	No specify quick start code														No code	
	Refer to Range Code Table.														□□□	
Instrument specification	Version symbol															Y

¹ If any one of the transmission outputs is specified (other than the code "N"), the digital inputs (from DI1 to DI4) are automatically added.

² If any one of the communication functions is also specified (other than the code "N"), the digital inputs (from DI1 to DI4) are automatically added.

³ Factory set value of Communication 2 protocol: Intercontroller communication

● Output Code Table

Output type	Code
Voltage output (0 to 1 V DC) *	3
Voltage output (0 to 5 V DC)	4
Voltage output (0 to 10 V DC)	5

* 0 to 1 V DC output can be specified only for transmission output (AO).

Output type	Code
Voltage output (1 to 5 V DC)	6
Current output (0 to 20 mA DC)	7
Current output (4 to 20 mA DC)	8

● Range Code Table

[Thermocouple (TC) input, RTD input]

Type	Code	Measured range	Code	Measured range
K	K35	-200.0 to +400.0 °C	KC4	-328.0 to +400.0 °F
	K40	-200.0 to +800.0 °C	KC6	-250.0 to +800.0 °F
	K41	-200 to +1372 °C	KC5	-328 to +2502 °F
	K09	0.0 to 400.0 °C	KA4	0.0 to 800.0 °F
	K10	0.0 to 800.0 °C	KA1	0 to 800 °F
	K02	0 to 400 °C	KA2	0 to 1600 °F
	K04	0 to 800 °C		
	J	J27	-200.0 to +400.0 °C	JC6
J32		-200.0 to +800.0 °C	JC7	-200.0 to +700.0 °F
J15		-200 to +1200 °C	JB9	-328 to +2192 °F
J08		0.0 to 400.0 °C	JB6	0.0 to 800.0 °F
J09		0.0 to 800.0 °C	JA1	0 to 800 °F
J02		0 to 400 °C	JA2	0 to 1600 °F
J04		0 to 800 °C		
T		T19	-200.0 to +400.0 °C	TC2
E	E21	-200.0 to +700.0 °C	EA9	-328.0 to +1292.0 °F
	E06	-200 to +1000 °C	EB1	-328 to +1832 °F
S	S06	-50 to +1768 °C	SA7	-58 to +3214 °F
R	R07	-50 to +1768 °C	RA7	-58 to +3214 °F
B	B03	0 to 1800 °C	BB2	0 to 3272 °F
N	N02	0 to 1300 °C	NA7	0 to 3272 °F
PLII	A02	0 to 1390 °C	AA2	0 to 2534 °F
W5Re/W26Re	W03	0 to 2300 °C	WA2	0 to 4200 °F
U	U04	0.0 to 600.0 °C	UB2	32.0 to 1112.0 °F
L	L04	0.0 to 900.0 °C	LA9	32.0 to 1652.0 °F
Pt100	D34	-100.00 to +100.00 °C	DD1	-200.0 to +200.0 °F
	D21	-200.0 to +200.0 °C	DC8	-199.99 to +199.99 °F
	D35	-200.0 to +850.0 °C	DC9	-328.0 to +1562.0 °F
JPt100	P29	-100.00 to +100.00 °C	PC8	-199.99 to +199.99 °F
	P30	-200.0 to +640.0 °C	PC9	-328.0 to +1184.0 °F
			PD1	-200.0 to +200.0 °F

[Voltage input, Current input]

Type	Code	Measured range
0 to 10 mV DC	101	Programmable range -19999 to +19999 [The decimal point position is selectable] (Factory set value: 0.0 to 100.0)
0 to 100 mV DC	201	
0 to 1 V DC	301	
0 to 5 V DC	401	
0 to 10 V DC	501	
1 to 5 V DC	601	
0 to 20 mA DC	701	
4 to 20 mA DC	801	
-100 to +100 mV DC	901	
-1 to +1 V DC	902	
-10 to +10 mV DC	903	

■ Quick start code 2 (Initial setting code)

Quick start code 2 tells the factory to ship with each parameter preset to the values detailed as specified by the customer. Quick start code is not necessarily specified when ordering, unless the preset is requested. These parameters are software selectable items and can be re-programmed in the field via the manual.

□ □ - □ □ □ □ - □ □
 (1) (2) (3) (4) (5) (6) (7) (8)

Specifications		Quick start code 2 (Initial setting code)							
		(1)	(2)	(3)	(4)	(5)	(6)	(7)	(8)
Output assignment	OUT1, OUT2, DO1 to DO4 (Refer to Output Assignment Code Table)	<input type="checkbox"/>							
Remote setting input *	Voltage input (0 to 10 mV DC)		1						
	Voltage input (0 to 100 mV DC)		2						
	Voltage input (0 to 1 V DC)		3						
	Voltage input (0 to 5 V DC)		4						
	Voltage input (0 to 10 V DC)		5						
	Voltage input (1 to 5 V DC)		6						
	Current input (0 to 20 mA DC)		7						
	Current input (4 to 20 mA DC)		8						
Event function 1 (EV1)	None			N					
	Refer to Event Type Code Table		<input type="checkbox"/>						
Event function 2 (EV2)	None				N				
	Refer to Event Type Code Table			<input type="checkbox"/>					
Event function 3 (EV3)	None					N			
	Refer to Event Type Code Table					<input type="checkbox"/>			
Event function 4 (EV4)	None						N		
	Refer to Event Type Code Table						<input type="checkbox"/>		
	Control loop break alarm (LBA)							5	
CT type	CT1 (none), CT2 (none)								N
	CT1 (CTL-6-P-N), CT2 (none)								P
	CT1 (CTL-12-S56-10L-N), CT2 (none)								S
	CT1 (CTL-6-P-N), CT2 (CTL-6-P-N)								T
	CT1 (CTL-12-S56-10L-N), CT2 (CTL-12-S56-10L-N)								U
Communication 1 protocol	None								N
	RKC communication (ANSI X3.28-1976)								1
	Modbus								2

* Specify "8" when the remote setting input signal is not used.

● Output Assignment Code Table

Code	Output 1 (OUT1)	Output 2 (OUT2)	Digital output 1 (DO1)	Digital output 2 (DO2)	Digital output 3 (DO3)	Digital output 4 (DO4)
1	Control output 1	Control output 2	Event function 1 (EV1)	Event function 2 (EV2)	Event function 3 (EV3)	Event function 4 (EV4)
2	Control output 1	Control output 2	Event function 1 (EV1)	Event function 2 (EV2)	Event function 3 (EV3)	HBA1, HBA2
3	Control output 1	Control output 2	Event function 1 (EV1)	Event function 2 (EV2)	HBA1, HBA2	FAIL (De-energized)
4	Control output 1	Control output 2	Event function 1 (EV1)	HBA1, HBA2	Event function 3 (EV3)	Event function 4 (EV4)
5	Control output 1	HBA1, HBA2	Event function 1 (EV1)	Event function 2 (EV2)	Event function 3 (EV3)	Event function 4 (EV4)
6	Control output 1	HBA1, HBA2	Event function 1 (EV1)	Event function 2 (EV2)	Event function 3 (EV3)	FAIL (De-energized)
7	Control output 1	FAIL (De-energized)	Event function 1 (EV1)	Event function 2 (EV2)	Event function 3 (EV3)	Event function 4 (EV4)

- Energized/De-energized is configurable except for the FAIL output. (Factory shipment: Energized)
- An output logic becomes OR output when two or more output functions are assigned to one output.
- Invalid for a non-existing output/event function.
- When used as Heat/Cool PID control or Position proportioning PID control, select any code of 1 to 4.

● Event Type Code Table

Code	Type	Code	Type	Code	Type
A	Deviation high	H	Process high	V	SV high
B	Deviation low	J	Process low	W	SV low
C	Deviation high/low	K	Process high with hold action	1	MV1 high [heat-side]
D	Band	L	Process low with hold action	2	MV1 low [heat-side]
E	Deviation high with hold action	Q	Deviation high with re-hold action	3	MV2 high [cool-side]
F	Deviation low with hold action	R	Deviation low with re-hold action	4	MV2 low [cool-side]
G	Deviation high/low with hold action	T	Deviation high/low with re-hold action		

1.4 Parts Description

This section describes various display units and the key functions.

■ Front Panel View

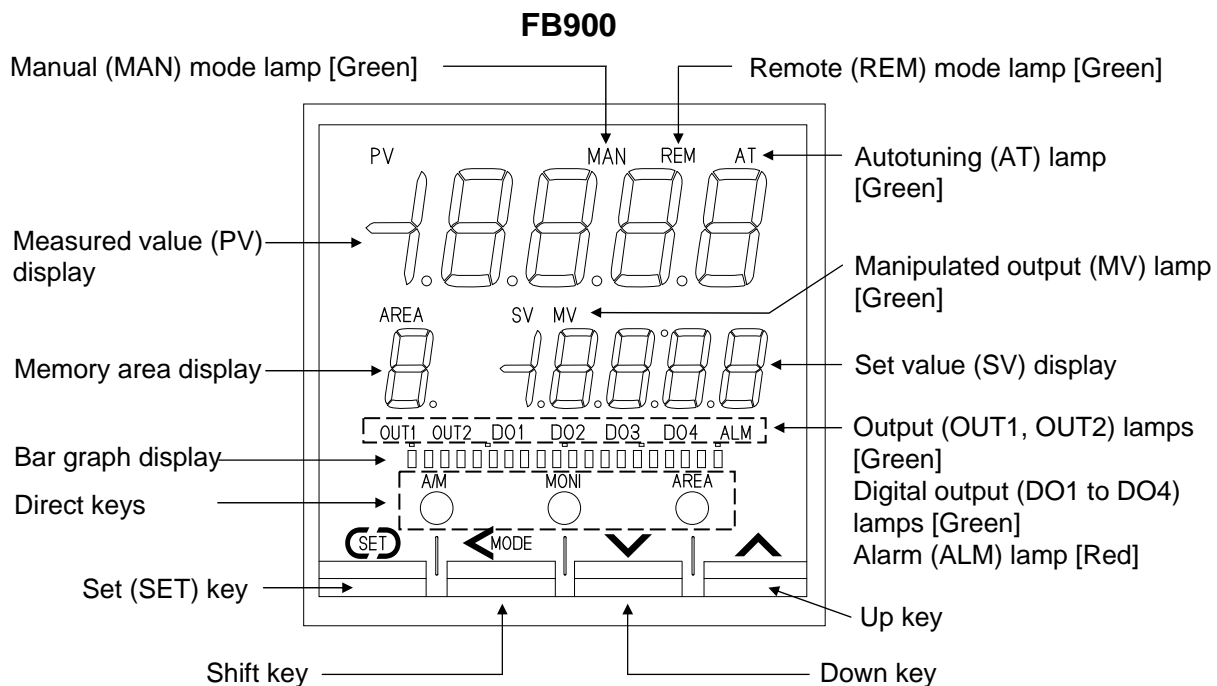
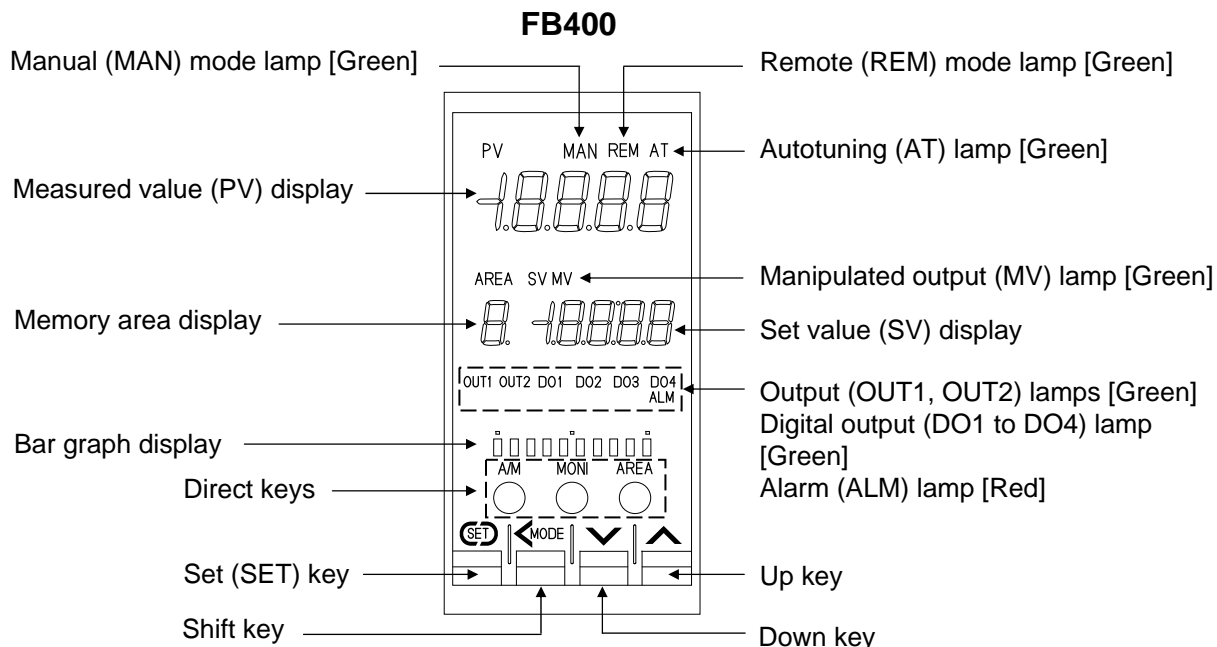

● **Display units**



Measured value (PV) display [Green]	Displays Measured value (PV) or various parameters' symbols.
Set value (SV) display [Orange]	Displays Set value (SV), Manipulated output value (MV) or various parameters' set values.
Memory area display [Orange]	Displays memory area number (1 to 8).

● **Indication lamps**

Manual (MAN) mode lamp [Green]	Lights when operated in Manual mode.
Remote (REM) mode lamp [Green]	Lights when operated in Remote mode.
Autotuning (AT) lamp [Green]	Flashes when Autotuning is activated. (After autotuning is completed: AT lamp will go out)
Manipulated output (MV) lamp [Green]	Lights when operated in Manual mode. In this case, the Set value (SV) display shows the Manipulated output value (MV).
Output (OUT1, OUT2) lamp [Green]	Lights when the output corresponding to each lamp is ON. ● Lamp indication becomes as follows for current output or voltage output: For an output of less than 0 %: Extinguished For an output of more than 0 % but less than 100 %: Dimly lit For an output of more than 100 %: Lit
Digital output (DO1 to DO4) lamp [Green]	Lights when the output corresponding to each lamp is ON.
Alarm (ALM) lamp [Red]	Lights when alarm (Event or Heater break alarm [HBA]) is turned ON. The type of alarm which is on can be checked on the event monitor screen.

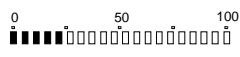
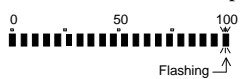

 These lamps work with event outputs (event function, HBA function, LBA function) which are assigned to OUT, DO and ALM. For assignment of outputs to OUT, DO and ALM, refer to the section **7.5 Engineering Mode (P. 7-48)**.

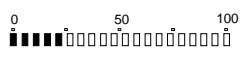
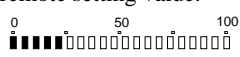
● **Bar graph display [Green] ***

Manipulated output values (MV1, MV2) [Factory set value]	Displays the Manipulated output value (MV). When Manipulated output value (MV) is at 0 % or less, the left-end dot of the bar-graph flashes. When MV exceeds 100 %, the right-end dot flashes. [Example] 
	● Heat/Cool PID control: When both OUT1 and OUT2 light, this means overlapping, but in this case the bar graph displays only the Manipulated output value (MV1) [heat-side].
	● Position proportioning PID control: [With FBR input] Displays the FBR input value (0.0 to 100.0 %). [Without FBR input] Cannot be used as a bar graph. The bar graph displays the over-scaled state (an output of more than 100 %). In this case, it is recommended to be set to "No display." [Example]  Flashing 
Measured value (PV)	Displays the Measured value (PV). Scaling is available within the input range (Input scale low to Input scale high). [Example] 
Set value (SV) monitor	Displays the Set value (SV). Scaling is available within the input range (Input scale low to Input scale high). Remote mode: Displays the remote setting value. [Example] 

Continued on the next page.

Continued from the previous page.

Deviation value	Displays the deviation between the Measured value (PV) and the Set value (SV). When the Deviation display is selected, the dots at both ends of bar-graph light. (Bar graph resolution: Refer to P. 7-65) [Example] 
Current transformer 1 (CT1) input value Current transformer 2 (CT2) input value	Displays the input value (current value) of CT1 or CT2. (Unit: A) A display resolution per dot is settable. (Bar graph resolution: Refer to P. 7-65) [Example] 

* The number of dots: 10 dots (FB400) 20 dots (FB900)



The factory set value of the bar graph is “Manipulated output value.” Bar graph display type can be changed by the bar graph in the Engineering mode. (Refer to P. 7-63)

● Direct keys

A/M	Auto/Manual transfer key	Switching the Auto/Manual control mode between Auto mode and Manual mode. [Type1, Type2]
MONI	Monitor key	Use to switch the monitor screen. Pressing the MONI key while any screen other than the SV setting & monitor mode screen is being displayed returns to the Measured value (PV)/Set value (SV) monitor screen. [Type 1]
AREA	Area key	Pressing the AREA key changes to Memory area transfer screen. [Type 1]
R/L	Remote/Local transfer key	Switching the Remote/Local control mode between Remote mode and Local mode. [Type 2]
R/S	RUN/STOP transfer key	Switching the RUN/STOP mode between RUN and STOP status. [Type 2]



To avoid damage to the instrument, never use a sharp object to press keys.



There are direct key type of Type 1 and Type 2. [Factory set value: Type 1] (Refer to P. 7-68)







Use/Unused of Direct key functions is programmable. (Refer to P. 7-67, P. 7-68)



To prevent operator error, a Direct key cannot be operated in positioning adjustment (automatic adjustment).

● Operation keys

	Set (SET) key	Used for parameter calling up and set value registration.
	Shift key	Shift digits when settings are changed. Used to selection operation between modes.
	Down key	Decrease numerals. Keeping pressing the DOWN key makes numeric value change faster. (Manual mode)
	Up key	Increase numerals. Keeping pressing the UP key makes numeric value change faster. (Manual mode)



To avoid damage to the instrument, never use a sharp object to press keys.

■ **Bottom View**

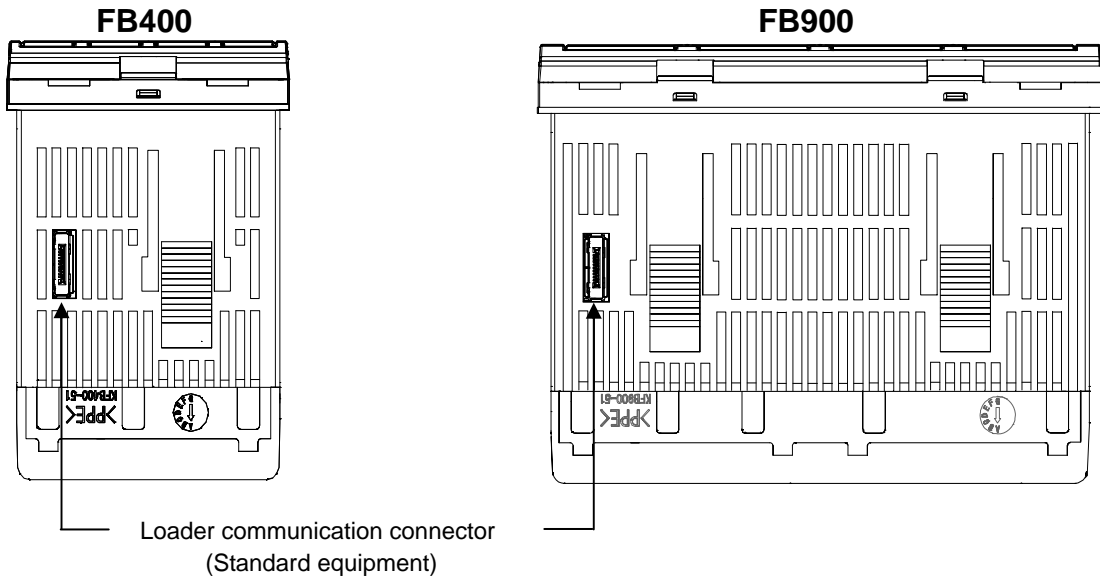

Use our communication converter COM-K (sold separately) to connect FB400/900 Series and personal computer. Then, the cable (cable length: 1.5 meters) for connection between FB400/900 series and our communication converter COM-K is optional.

■ **Side view (common to FB400/900)**

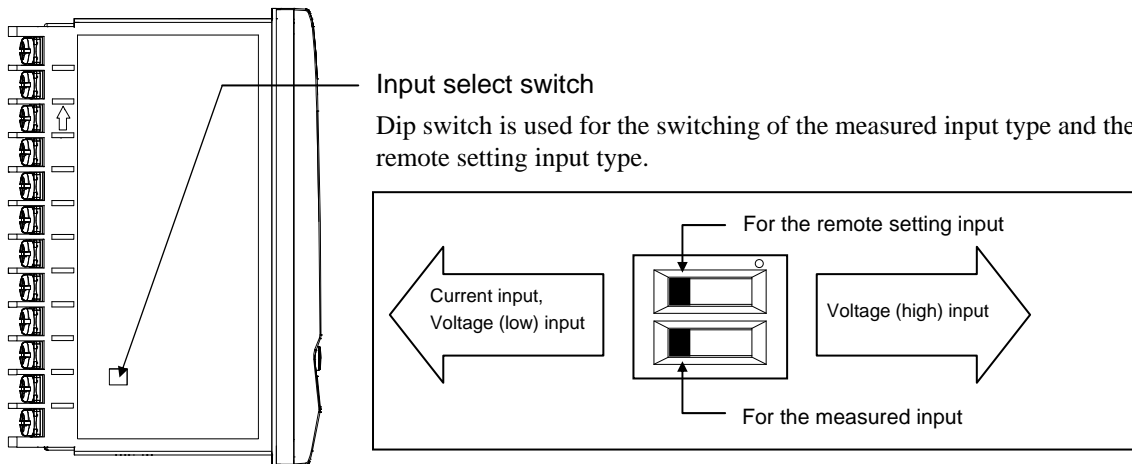

To change the input type, refer to **Input type (P. 7-69)**, **Remote setting input type (P. 7-77)** in the Engineering mode.

1.5 Input/Output Functions

This section describes the Input/Output functions of the instrument. To learn how to set each function, refer to the respective page.

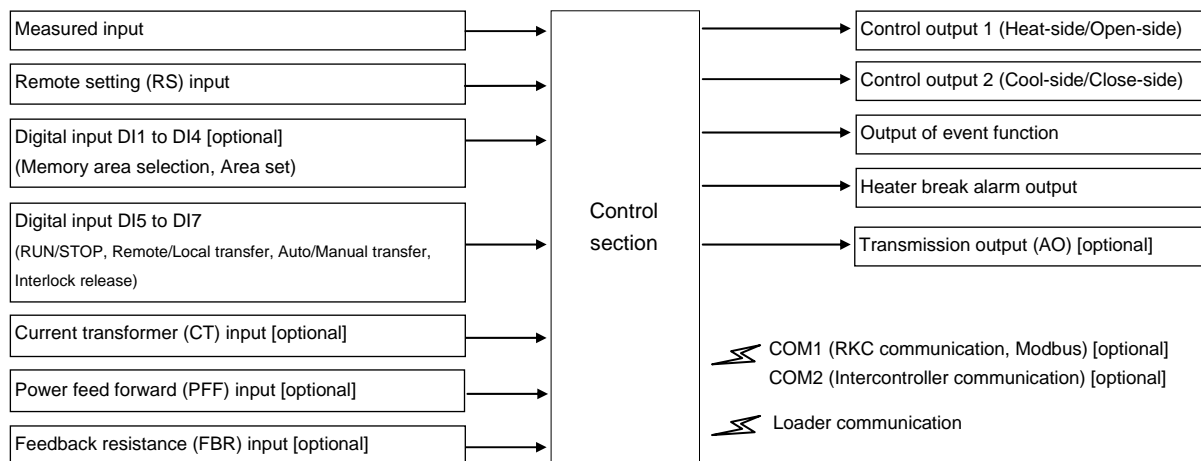

- Input** In addition to measured input and Remote setting (RS) input, 4 optional input functions are available.

Measured input [universal input]:

- Input groups available for measured inputs are shown in the table below. (P. 7-69)

Voltage (low) input group	Thermocouple	K, J, E, T, S, R, B, N, PLII, W5Re/W26Re, U, L
	RTD	Pt100, JPt100
	Voltage (low)	0 to 1 V DC, 0 to 100 mV DC, 0 to 10 mV DC, -100 to +100 mV DC, -10 to +10 mV DC
	Current	0 to 20 mA DC, 4 to 20 mA DC
Voltage (high) input group		-1 to +1 V DC, 0 to 5 V DC, 1 to 5 V DC, 0 to 10 V DC

[Factory set value: Thermocouple K (When quick start code "N" is specified)]

- When the input type is changed, be sure to check the details of setting of the input group transfer and the input type selection by the input select switch. (P. 7-69)

Remote setting (RS) input [universal input]

- Remote input is to change a control set point by using current or voltage input from an external device.
- Measured input is not isolated from Remote setting (RS) input.
- Input groups available for Remote setting (RS) inputs are shown in the table below. (P. 7-77)

Voltage (low) input and Current input group	0 to 100 mV DC, 0 to 10 mV DC, 0 to 1 V DC
	0 to 20 mA DC, 4 to 20 mA DC
Voltage (low) input group	0 to 5 V DC, 1 to 5 V DC, 0 to 10 V DC

[Factory set value: Depend on model code]

- When using the Intercontroller communication (only slave controller of cascade control and ratio setting), the Remote setting (RS) input function becomes invalid.

Digital input [DI1 to DI4 (optional), DI5 to DI7]

- Digital input (contact input signal from the external devices) can be used for the following functions.

DI1 to DI4	Memory area selection (number of area: 1 to 8) + Area set
DI5 to DI7	RUN/STOP, Remote/Local transfer, Auto/Manual transfer, Interlock release

- For function assignment to the digital input (DI5 to DI7), set the Digital input (DI) assignment (P. 7-78) in the Engineering mode.

Current transformer (CT) input (optional)

- CT input is used for Heater break alarm function to detect a heater break or short-circuit.
- Up to two CT inputs can be selected. (Specify when ordering)
- Two types of CT available.

CTL-6-P-N (for 0 to 30 A)
CTL-12-S56-10L-N (for 0 to 100 A)

- Only one CT input is available when power feed forward (PFF) input is selected.
- Measured input is not isolated from CT input.
- If there is CT input, power frequency is automatically set by the power frequency detection function. However, no frequency may be able to be detected if at a CT value of less than 0.5 A.
- The setting of a CT ratio (refer to P. 7-116 and P. 7-120) and the CT assignment (refer to P. 7-117 and P. 7-121) of the Engineering mode are necessary to use a current transformer (CT) input.

Power feed forward (PFF) input (optional)

- Power feed forward (PFF) input is used for Power feed forward function to achieve accurate control. PFF monitors power supply voltage variation on a device and compensates control output from the controller.
- Two types of dedicated transformer are available. (Specify either of them when ordering)

PFT-01	100 V type transformer (100 to 120 V AC)
PFT-02	200 V type transformer (200 to 240 V AC)

- Power feed forward (PFF) input cannot be used simultaneously with Feedback resistance (FBR) input.
- If there is Power feed forward (PFF) input, power frequency is automatically set by the power frequency detection function.

Feedback resistance (FBR) input (optional)

- When the control type is the Position proportioning PID control (with FBR input), a valve position from the control motor can be inputted to feedback resistance.
- Measured input is not isolated from Feedback resistance (FBR) input.
- Feedback resistance (FBR) input cannot be used with Current transformer (CT) input and Power feed forward (PFF) input.

- Output** Up to seven outputs are available. They may be used as control output (OUT), digital output (DO) or transmission output (AO) by specifying the output type or by activating the output assignment function.

Output 1 (OUT1), Output 2 (OUT2)

- The following output functions can be assigned to OUT1 and/or OUT2 at the output assignment of the Engineering mode (P. 7-79):
 - Control output,
 - Heater break alarm output, or
 - FAIL (De-energized fixed: contact opens under FAIL)
- For Heat/Cool PID control, OUT1 corresponds to the heat-side output and OUT2 corresponds to the cool-side output.
- For Position proportioning PID control, OUT1 corresponds to the open-side output and OUT2 corresponds to the close-side output.
- Output types available for OUT1 and OUT2 are shown in the table below. (Specify when ordering)

Relay contact output	250 V AC 3 A (Resistive load), 30 V DC 1 A (Resistive load), 1a contact
Voltage pulse output	0/12 V DC (Allowable load resistance: 600 Ω or more)
Voltage output	0 to 5 V DC, 1 to 5 V DC, 0 to 10 V DC (Allowable load resistance: 1 kΩ or more)
Current output	0 to 20 mA DC, 4 to 20 mA DC (Allowable load resistance: 600 Ω or less)
Triac output	0.5 A (Allowable load current)
Open collector output	30 V DC or less, 100 mA (Allowable load current), Sink type

- There is not isolation between OUT1 and OUT2.
- When OUT1 and OUT2 can be used for relay contact output or triac output, there is isolation between each output (OUT1, OUT2, AO).

Digital output 1 to 4 (DO1 to DO4)

- The following output functions can be assigned to DO1 through DO4 at the output assignment of the Engineering mode (P. 7-79):
 - Output of event function,
 - Heater break alarm output, or
 - FAIL (De-energized fixed: contact opens under FAIL)
- The output type for DO1 to DO4 is relay only. (Specify when ordering)

Relay contact output	250 V AC 1 A (Resistive load), 30 V DC 1 A (Resistive load), 1a contact
----------------------	---

Transmission output (AO)

- Output types available for transmission output are shown in the table below. (Specify when ordering)

Voltage output	0 to 1 V DC, 0 to 5 V DC, 1 to 5 V DC, 0 to 10 V DC (Allowable load resistance: 1 kΩ or more)
Current output	0 to 20 mA DC, 4 to 20 mA DC (Allowable load resistance: 600 Ω or less)

- Parameter values shown in the following table can be output by Transmission output (P. 7-83). These transmission output data can be output after being scaled.

Measured value (PV)	Set value (SV) monitor	Deviation value
Manipulated output value (MV1) [heat-side]	Manipulated output value (MV2) [cool-side]	Set value (SV)
Remote setting (RS) input value		

- Number of output: 1 point

■ Communication

Communication 1 (optional)

- Communication 1 (COM1) is used for the Host communication.
- Communication protocol is used for RKC communication (ANSI X3.28-1976) or Modbus. (Specify when ordering)
- Communication interface:
RS-422A *, RS-485, or RS-232C (Specify when ordering)
* When Communication 1 is used for RS-422A, no Communication 2 can be used.

 For details of the Host communication, refer to the separate **FB100/FB400/FB900 Communication Instruction Manual (IMR01W04-E□)**.

Communication 2 (optional)

- Communication 2 (COM2) is used for the Intercontroller communication. Data can be exchanged between two or more FB100s/400s/900s without using communication with analog signals such as remote setting input and analog output as well as with the host computer. (Refer to P. 6-60.)
- Interface: RS-485 only
- The following four functions become usable when the Intercontroller communication is used.
Automatic temperature rise function (with learning function)
Cascade control function
Ratio setting function
Group RUN/STOP function

Loader communication

- It is possible to manage data on the personal computer side by converting all of the data in the FB400/900 into one file.¹
- When starting the Loader communication, first your PC (Windows 2000/XP/Vista/7) being used is necessary to be installed with the communication tool².

¹ Use our communication converter COM-K (sold separately) to connect FB400/900 and your PC.

² The communication tool (WinUCI, PROTEM2) can be downloaded from the RKC official website: <http://www.rkcinst.com/>.

 **The Loader port is only for parameter setup.**

 The Loader communication corresponds to the RKC communication protocol “Based on ANSI X3.28-1976 subcategories 2.5 and A4.”

 For the COM-K, refer to the **COM-K Instruction Manual (IMR01Z01-E□)**.

[Connection example]

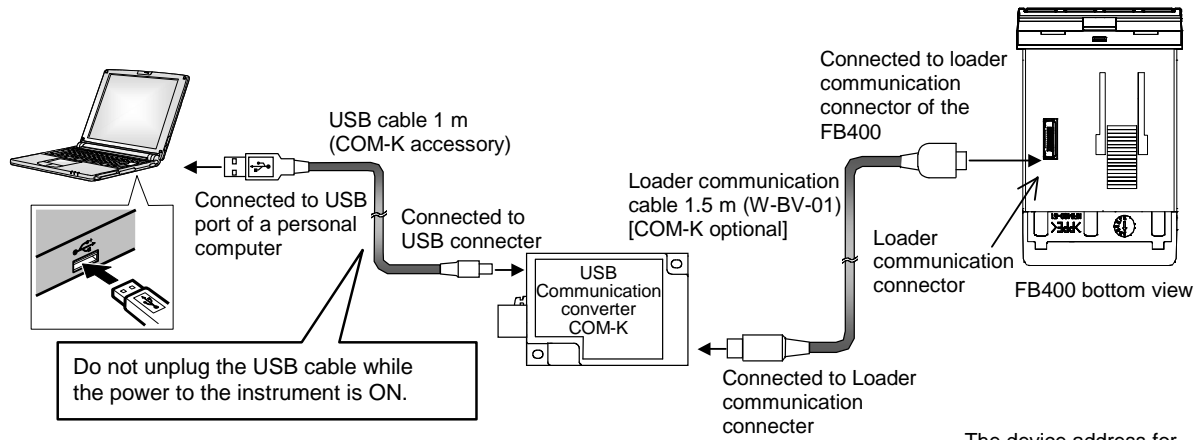

- Communication monitor tool WinUCI-A
Software operation environment: Windows 2000 or higher
- Communication setup tool WinUCI-B for FB series
Software operation environment: Windows 2000 or higher
- Communication tool PROTEM2
Software operation environment: Windows XP (Service Pack 2) or higher
PROTEM2 needs Microsoft .NET Framework 4.0 or later
- Communication port of host computer
USB port: Based on USB Ver. 2.0
- Communication settings on the computer
(Values other than the communication port are fixed.)
Communication speed: 38400 bps
Start bit: 1
Data bit: 8
Parity bit: Without
Stop bit: 1

The device address for Loader communication is fixed at "0."
The setting of the device address is disregarded.

MEMO

HANDLING PROCEDURE TO OPERATION



2

Handling Procedure to Operation

This chapter describes procedures to set operating conditions of a customer and parameter of various setting modes.

■ Setting procedure to operation

Conduct necessary setting before operation according to the procedure described below.

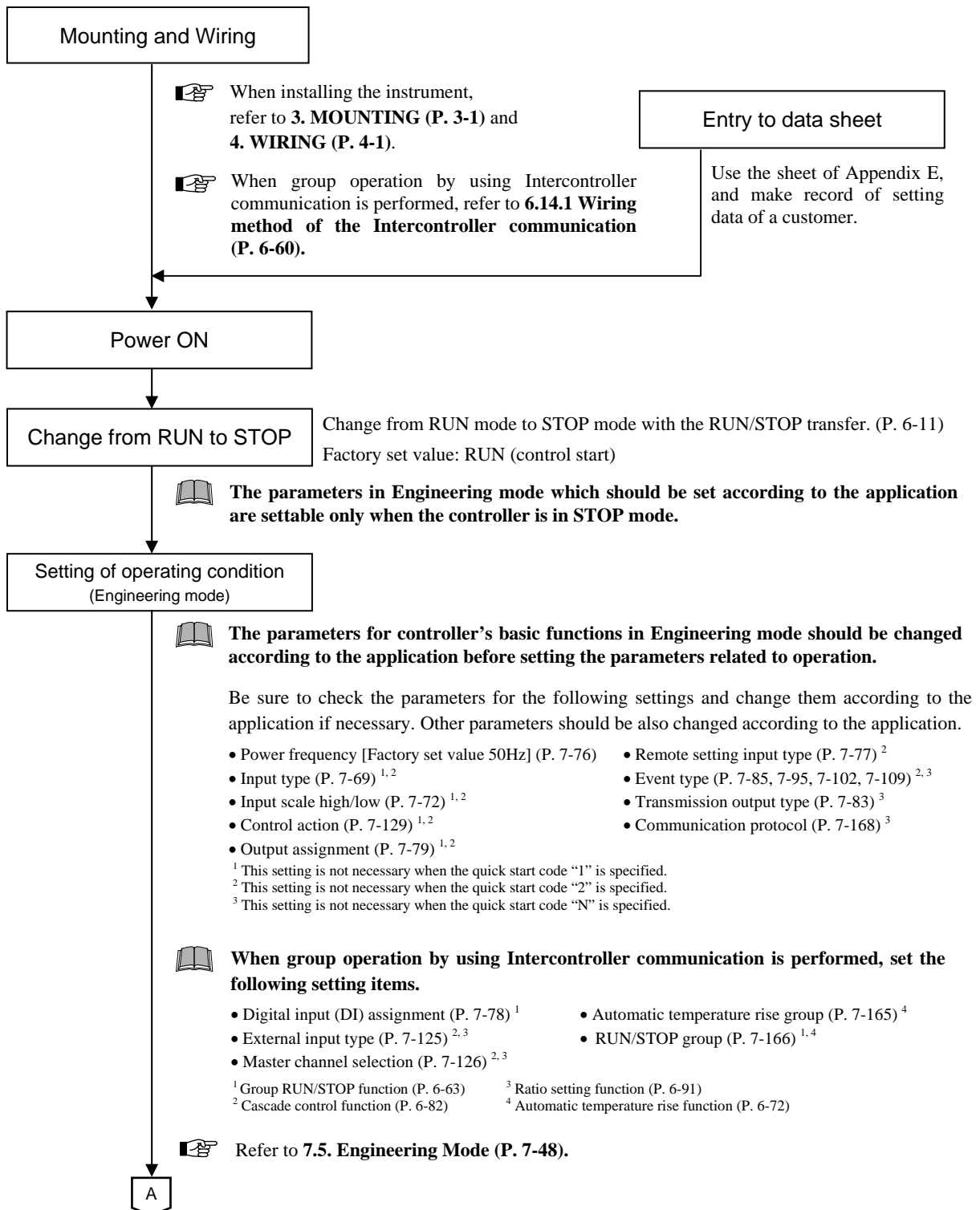

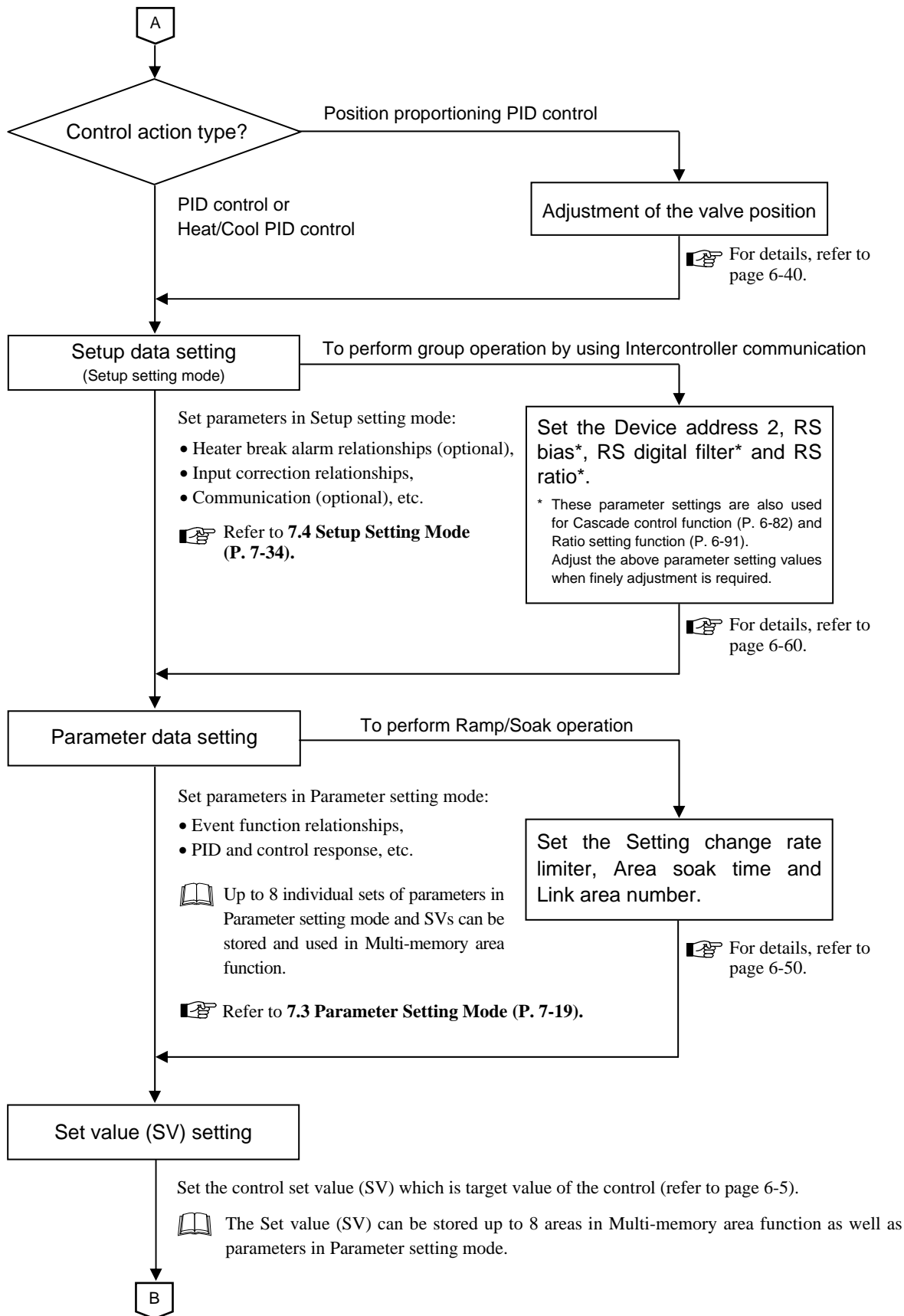

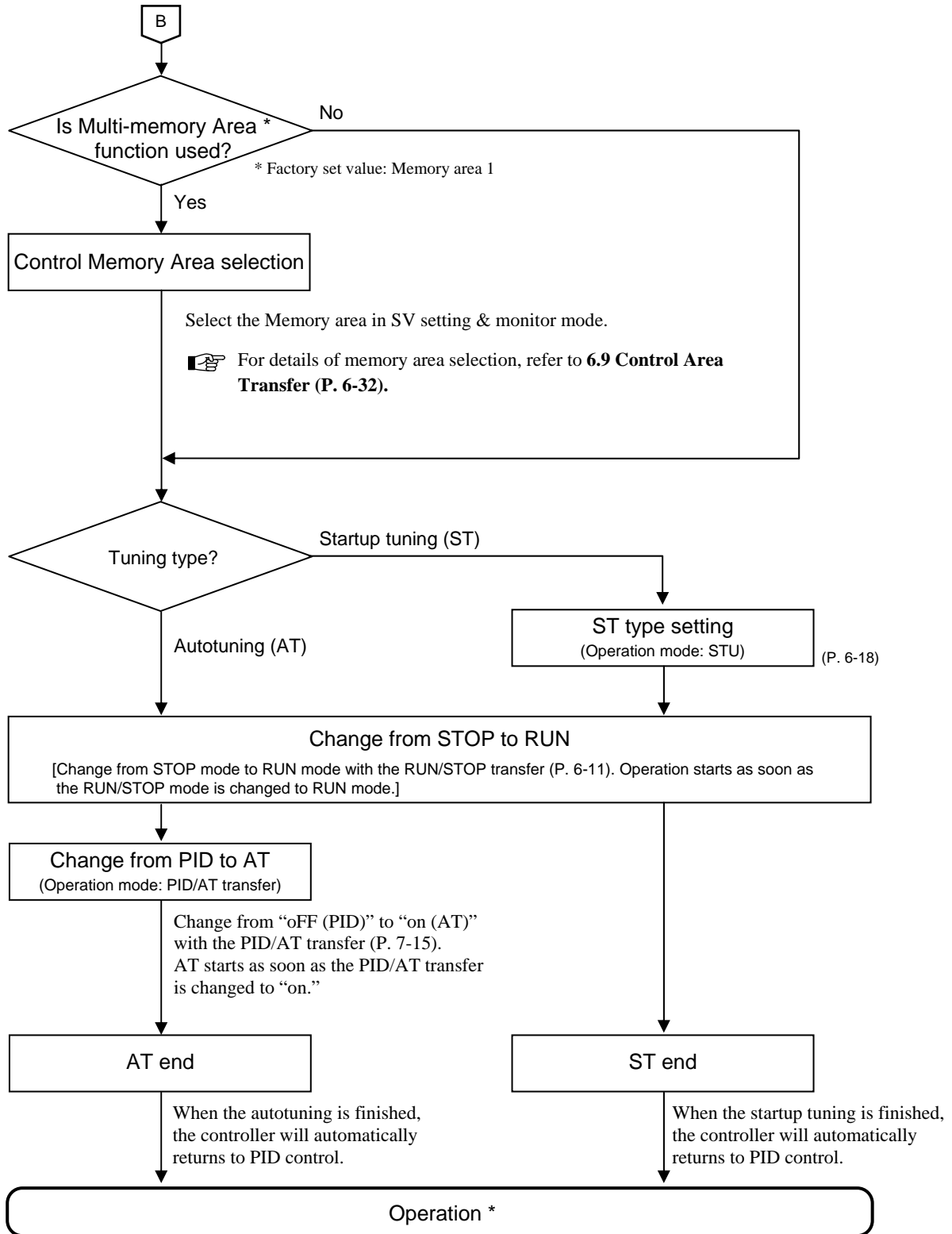

* Adjust the PID constants manually when the optimum PID constants cannot be computed by Autotuning for characteristic variations of the controlled system (refer to page 6-9).

MOUNTING



- 3.1 Mounting Cautions.....3-2
- 3.2 Dimensions3-3
- 3.3 Procedures of Mounting and Removing.....3-4

3.1 Mounting Cautions

This chapter describes installation environment, mounting cautions, dimensions and mounting procedures.



WARNING

To prevent electric shock or instrument failure, always turn off the power before mounting or removing the instrument.

- (1) This instrument is intended to be used under the following environmental conditions. **(IEC61010-1)**
[OVERVOLTAGE CATEGORY II, POLLUTION DEGREE 2]
- (2) Use this instrument within the following environment conditions:
 - Allowable ambient temperature: -10 to +50 °C
 - Allowable ambient humidity: 5 to 95 %RH
(Absolute humidity: MAX. W. C 29.3 g/m³ dry air at 101.3 kPa)
 - Installation environment conditions: Indoor use
Altitude up to 2000 m
- (3) Avoid the following conditions when selecting the mounting location:
 - Rapid changes in ambient temperature which may cause condensation.
 - Corrosive or inflammable gases.
 - Direct vibration or shock to the mainframe.
 - Water, oil, chemicals, vapor or steam splashes.
 - Excessive dust, salt or iron particles.
 - Excessive induction noise, static electricity, magnetic fields or noise.
 - Direct air flow from an air conditioner.
 - Exposure to direct sunlight.
 - Excessive heat accumulation.
- (4) Mount this instrument in the panel considering the following conditions:
 - Provide adequate ventilation space so that heat does not build up.
 - Do not mount this instrument directly above equipment that generates large amount of heat (heaters, transformers, semi-conductor functional devices, large-wattage resistors.)
 - If the ambient temperature rises above 50 °C, cool this instrument with a forced air fan, cooler, etc. Cooled air should not blow directly on this instrument.
 - In order to improve safety and the immunity to withstand noise, mount this instrument as far away as possible from high voltage equipment, power lines, and rotating machinery.
 - High voltage equipment: Do not mount within the same panel.
 - Power lines: Separate at least 200 mm.
 - Rotating machinery: Separate as far as possible.
 - Mount this instrument in the horizontal direction for panel. If you did installation except a horizontal direction, this causes malfunction.
- (5) If this instrument is permanently connected to equipment, it is important to include a switch or circuit-breaker into the installation. This should be in close proximity to the equipment and within easy reach of the operator. It should be marked as the disconnecting device for the equipment.

3.3 Procedures of Mounting and Removing

■ Mounting procedures

1. Prepare the panel cutout as specified in **3.2 Dimensions**.
(Panel thickness: 1 to 10 mm)
2. Insert the instrument through the panel cutout.
3. Insert the mounting bracket into the mounting groove of the instrument. (Fig. 3.1)
4. Push the mounting bracket forward until the bracket is firmly secured to the panel. (Fig. 3.2)
5. Only turn one full revolution after the screw touches the panel. (Fig. 3.3)
6. The other mounting bracket should be installed the same way described in 3. to 5.

 The front of the instrument conforms to **IP66 (NEMA4X)** when mounted on the panel. For effective Waterproof/Dustproof, the gasket must be securely placed between instrument and panel without any gap. If gasket is damaged, please contact RKC sales office or the agent.

 For replacing of rubber packing, refer to **APPENDIX B. Replacing the Waterproof/ Dustproof Rubber Packing (P. A-4)**.

(FB900 is used in the right figures for explanation, but the same mounting procedures also apply to FB400.)

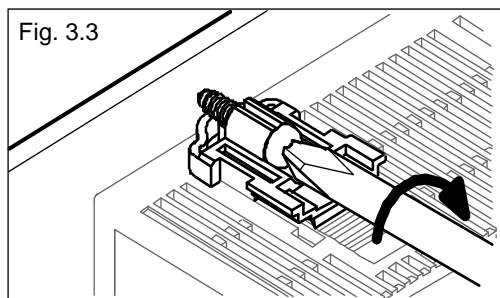
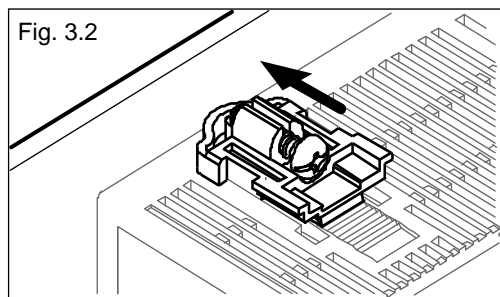
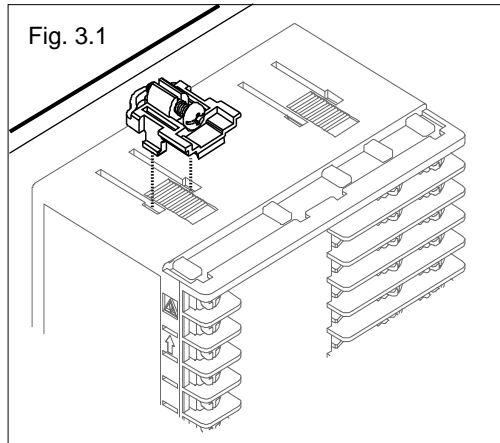

■ Removing procedures

1. Turn the power OFF.
2. Remove the wiring.
3. Loosen the screw of the mounting bracket. (Fig. 3.4)
4. Lift the latch of the mounting bracket (①), then pull the mounting bracket (②) to remove it from the case. (Fig. 3.4)
5. The other mounting bracket should be removed in the same way as described in 3. and 4.
6. Pull out the instrument from the mounting cutout while holding the front panel frame of this instrument. (Fig. 3.5)

 Use long-nose pliers to remove mounting brackets from the instrument that is installed in a narrow place or installed tightly in a vertical position.

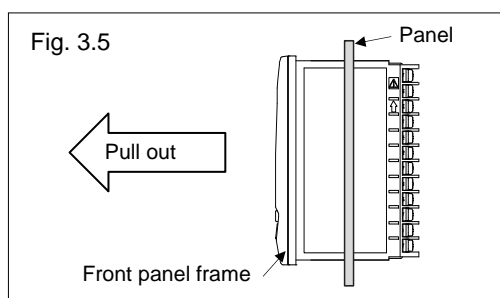
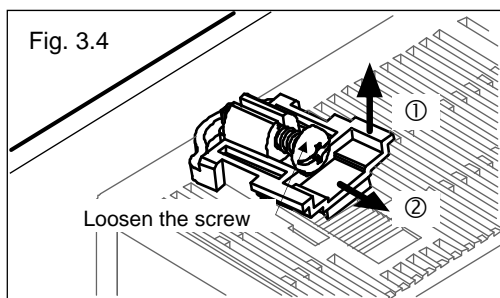
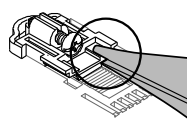

WIRING



4.1 Wiring Cautions	4-2
4.2 Terminal Layout	4-5
4.3 Wiring of Each Terminal	4-7
4.4 Handling of the Terminal Cover [optional].....	4-15

4.1 Wiring Cautions

This chapter describes wiring cautions, wiring layout and wiring of terminals.



WARNING

To prevent electric shock or instrument failure, do not turn on the power until all wiring is completed. Make sure that the wiring is correct before applying power to the instrument.

- For thermocouple input, use the appropriate compensation wire.
- For RTD input, use low resistance lead wire with no difference in resistance between the three lead wires.
- To avoid noise induction, keep input signal wire away from instrument power line, load lines and power lines of other electric equipment.
- If there is electrical noise in the vicinity of the instrument that could affect operation, use a noise filter.
 - Shorten the distance between the twisted power supply wire pitches to achieve the most effective noise reduction.
 - Always install the noise filter on a grounded panel. Minimize the wiring distance between the noise filter output and the instrument power supply terminals to achieve the most effective noise reduction.
 - Do not connect fuses or switches to the noise filter output wiring as this will reduce the effectiveness of the noise filter.

- About five seconds are required as preparation time for contact output every time the instrument is turned on. Use a delay relay when the output line is used for an external interlock circuit.
- Power supply wiring must be twisted and have a low voltage drop.
- For an instrument with 24 V power supply, supply power from a SELV circuit.
- A suitable power supply should be considered in end-use equipment. The power supply must be in compliance with a limited-energy circuits (maximum available current of 8 A).
- This instrument is not furnished with a power supply switch or fuse. Therefore, if a fuse or power supply switch is required, install close to the instrument.

Recommended fuse rating: Rated voltage 250 V, Rated current 1 A

Fuse type: Time-lag fuse

- Use the solderless terminal appropriate to the screw size.
 - Screw size: M3 × 7 (With 5.8 × 5.8 square washer)
 - Recommended tightening torque: 0.4 N·m (4 kgf·cm)

Applicable wire: Solid/Twisted wire of 0.25 to 1.65 mm²

Specified dimension: Refer to Fig. 4.1

Specified solderless terminals:

Manufactured by J.S.T MFG CO., LTD.

Circular terminal with isolation

V1.25-MS3

(M3 screw, width 5.5 mm, hole diameter 3.2 mm)

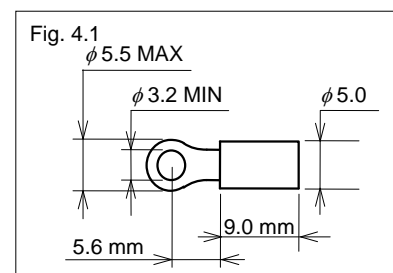

- Make sure that the any wiring such as solderless terminal is not in contact with the adjoining terminals.

- When making the connections, route from the left side toward the rear terminals as shown in Fig. 4.2. The central and right columns of terminals are slanted to facilitate connection from the left. If a terminal cover is used, connection from the right side is not possible. In a side-by-side installation, connecting from both the right and left sides may interfere with and prevent connections to the neighboring instrument.

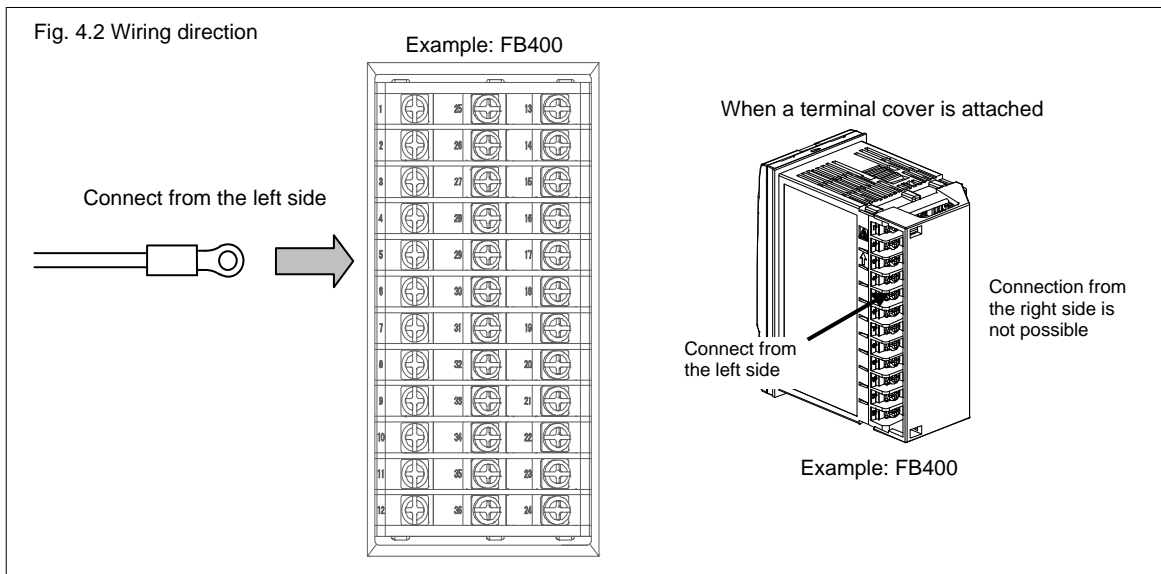

- Up to two solderless terminal lugs can be connected to one terminal screw. However, in this case, reinforced insulation cannot be used.

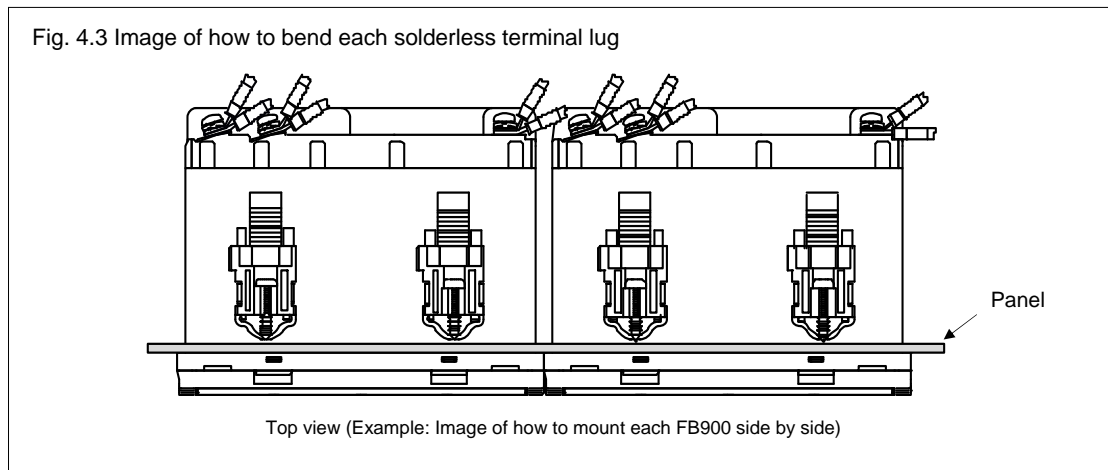

If solderless terminal lugs other than those in not specified dimensions are used, terminal screws may not be tightened. In such a case, bend each solderless terminal lug in advance and then conduct wiring. If the terminal screw is forcibly tightened, it may be damaged.

- Caution for the terminal cover usage:

If each solderless terminal lug touches the terminal cover, remove each projection from the terminal cover by manually bending it in front and in rear until broken. (Fig. 4.4)

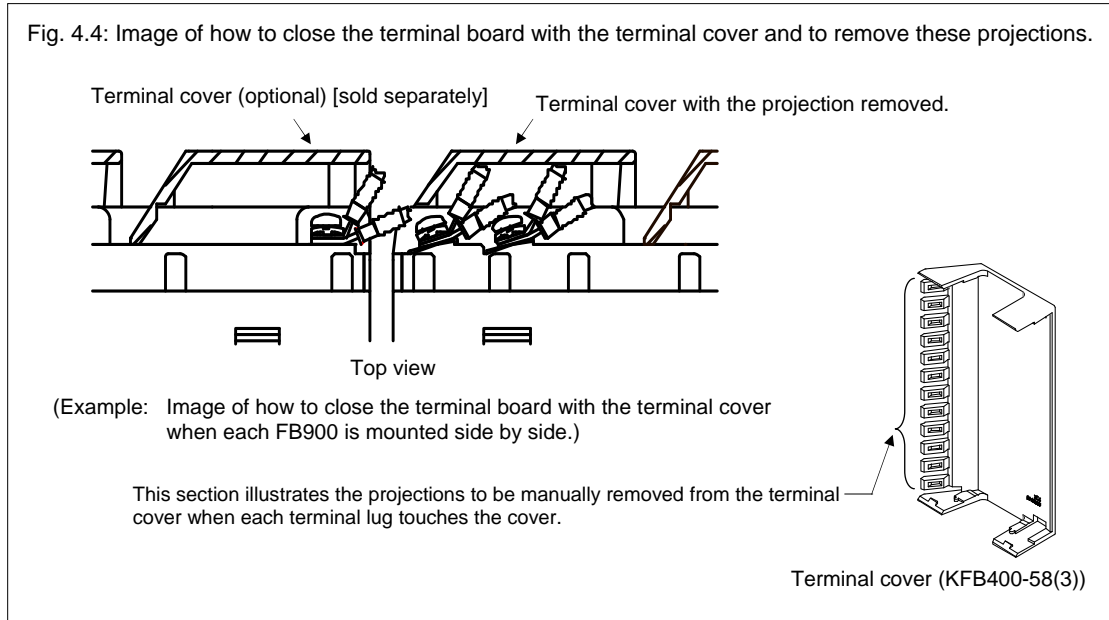

■ For the mounting and removing of the terminal cover, refer to **4.4 Handling of the Terminal Cover [optional] (P. 4-15)**.

4.2 Terminal Layout

The terminal layout is as follows.

■ FB400

Communication 1/
Communication 2 [optional]
Communication 1 (RS-422A, RS-232C, RS-485)
Communication 2 (RS-485)

Power supply voltage
100 to 240 V AC, 24 V AC, 24 V DC

Digital output 4 (DO4),
Digital output 3 (DO3) [optional]
Relay contact

Digital output 2 (DO2),
Digital output 1 (DO1) [optional]
Relay contact

Output 2 (OUT2)
Relay contact/Voltage pulse/Voltage/Current/
Triac/Open collector

Output 1 (OUT1)
Relay contact/Voltage pulse/Voltage/Current/
Triac/Open collector

Transmission output (AO)
[optional]
Voltage/Current

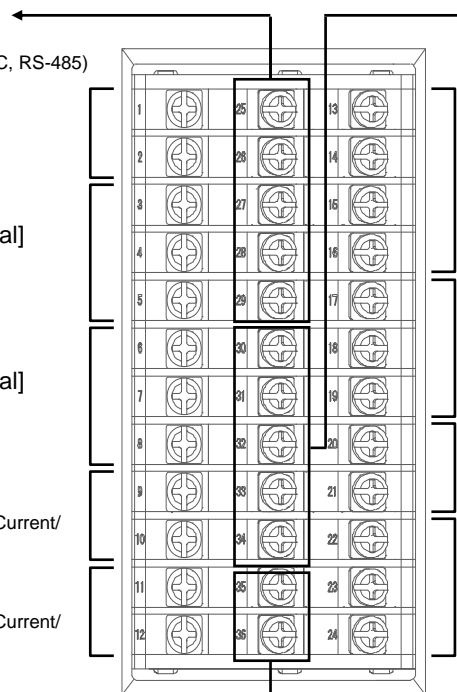

Digital input (DI1 to DI4) [optional]
For Memory area transfer

Digital input (DI5 to DI7) [standard]
For Mode transfer

Optional function
Current transformer (CT) input
Power feed forward (PFF) input
Feedback resistance (FBR) input

Remote setting (RS) input
[universal input]
Voltage/Current

Measured input [universal input]
Thermocouple/RTD/Voltage/Current

■ FB900

Communication 1/
Communication 2 [optional]
Communication 1 (RS-422A, RS-232C, RS-485)
Communication 2 (RS-485)

Power supply voltage
100 to 240 V AC, 24 V AC,
24 V DC

Digital output 4 (DO4),
Digital output 3 (DO3)
[optional]
Relay contact

Digital output 2 (DO2),
Digital output 1 (DO1)
[optional]
Relay contact

Output 2 (OUT2)
Relay contact/Voltage pulse/
Voltage/Current/Triac/
Open collector

Output 1 (OUT1)
Relay contact/Voltage pulse/
Voltage/Current/Triac/
Open collector

Transmission output (AO)
[optional]
Voltage/Current

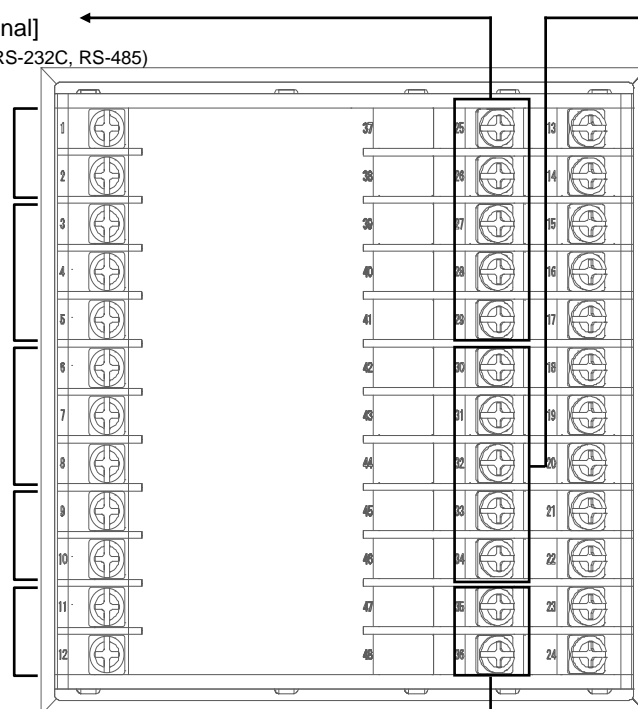

Digital input (DI1 to DI4)
[optional]
For Memory area transfer

Digital input (DI5 to DI7)
[standard]
For Mode transfer





Optional function
Current transformer (CT) input
Power feed forward (PFF) input
Feedback resistance (FBR) input

Remote setting (RS) input
[universal input]
Voltage/Current

Measured input
[universal input]
Thermocouple/RTD/Voltage/
Current

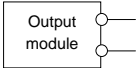
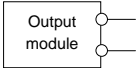
■ Isolations of input and output (common to FB400/900)

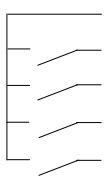
- : Isolated from each other circuit blocks.
- : Not isolated between inputs (or outputs).

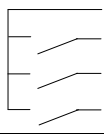
Power supply		Transmission output (AO)	
Measured input		Output 1 (OUT1) *	
Remote setting input		Output 2 (OUT2) *	
Current transformer (CT) input		Digital output 1 (DO1)	
Power feed forward (PFF) input		Digital output 2 (DO2)	
Feedback resistance (FBR) input		[Relay contact output (250 V AC 1A, 30 V DC 1 A)]	
Digital input (DI1)		Digital output 3 (DO3)	
Digital input (DI2)		Digital output 4 (DO4)	
Digital input (DI3)		[Relay contact output (250 V AC 1A, 30 V DC 1 A)]	
Digital input (DI4)			
Digital input (DI5)			
Digital input (DI6)			
Digital input (DI7)			
Communication 1/Communication 2			

* When OUT1 and OUT2 can be used for relay contact output (250 V AC 3 A, 30 V DC 1 A) or triac output, there is isolation between each output (OUT1, OUT2, AO).

4.3 Wiring of Each Terminal

Prior to conducting wiring, always check the polarity of each terminal.

■ Power supply

- Connect the power to terminal numbers 1 and 2.

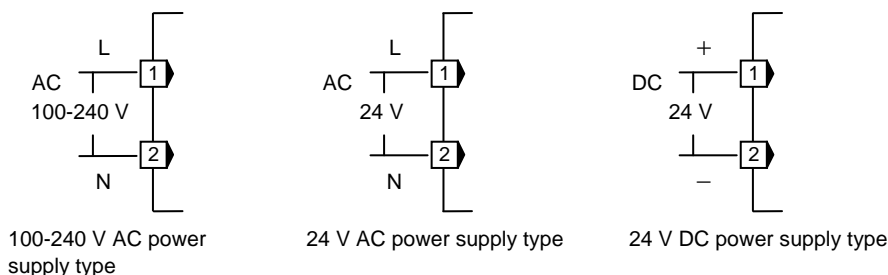

- Power supply types must be specified when ordering. Power supply voltage for the controller must be within the range shown below to accurate control accuracy.

Specification code	Power supply type	Power consumption
4	90 to 264 V AC (Power supply voltage range), [Rating 100 to 240 V AC] Power supply frequency: 50/60 Hz	FB400: 7.8 VA max. (at 100 V AC), 11.9 VA max. (at 240 V AC) FB900: 8.7 VA max. (at 100 V AC), 13.0 VA max. (at 240 V AC)
3	21.6 to 26.4 V AC (Power supply voltage range), [Rating 24 V AC] Power supply frequency: 50/60 Hz	FB400: 8.2 VA max. (at 24 V AC) FB900: 9.3 VA max. (at 24 V AC)
3	21.6 to 26.4 V DC (Power supply voltage range), [Rating 24 V DC]	FB400: 250 mA max. (at 24 V DC) FB900: 300 mA max. (at 24 V DC)

- If there is electrical noise in the vicinity of the instrument that could affect operation, use a noise filter.
- Power supply wiring must be twisted and have a low voltage drop.
- This instrument is not furnished with a power supply switch or fuse. Therefore, if a fuse or power supply switch is required, install close to the instrument.
Recommended fuse rating: Rated voltage 250 V, Rated current 1 A
Fuse type: Time-lag fuse
- For an instrument with 24 V power supply, supply power from a SELV circuit.
- A suitable power supply should be considered in end-use equipment. The power supply must be in compliance with a limited-energy circuits (maximum available current of 8 A).

■ Output 1 (OUT1)/Output 2 (OUT2)

- Terminal 11 and 12 are for output 1 (OUT1); Terminal 9 and 10 are for output 2 (OUT2).
- Connect an appropriate load according to the output type. (Specify when ordering)

	PID control (Direct/Reverse action)	Heat/Cool PID control (or Position proportioning PID control)	Wiring example
Relay contact output			
Voltage pulse output			
Voltage output/ Current output			
Triac output			
Open collector output			

- OUT1 is not isolated from OUT2.
- When OUT1 and OUT2 can be used for Relay contact output (250 V AC 3 A, 30 V DC 1 A) or Triac output, there is isolation between each output (OUT1, OUT2, AO).
- OUT1 and OUT2 can be used for control output, Heater break alarm output, or FAIL (De-energized fixed: Contact opens under FAIL). Refer to page 7-79.

Continued on the next page.

Continued from the previous page.

- Number of outputs and output types must be specified when ordering. The specifications of each output are as follows.

Specification code	Output type	Specifications
M	Relay contact output	250 V AC, 3A (Resistive load)/30 V DC, 1 A (Resistive load) 1a contact
V	Voltage pulse output	0/12 V DC (Allowable load resistance: 600 Ω or more)
4	Voltage output	0 to 5 V DC (Allowable load resistance: 1 k Ω or more)
5		0 to 10 V DC (Allowable load resistance: 1 k Ω or more)
6		1 to 5 V DC (Allowable load resistance: 1 k Ω or more)
7	Current output	0 to 20 mA DC (Allowable load resistance: 600 Ω or less)
8		4 to 20 mA DC (Allowable load resistance: 600 Ω or less)
T	Triac output	AC output (Allowable load current: 0.5 A [Ambient temperature 40 °C or less]), Load voltage: 75 to 250 V AC, Minimum load current: 30 mA, ON voltage: 1.6 V or less (at maximum load current)
D	Open collector output	Sink type (Allowable load current: 100 mA), Load voltage: 30 V DC or less, Minimum load current: 0.5 mA, ON voltage: 2 V or less (at maximum load current), Leakage current at OFF: 0.1 mA or less

■ Digital output 1 to 4 (DO1 to DO4) [optional]

- With Digital output (optional), terminals 3 through 5 (DO3, DO4) and 6 through 8 (DO1, DO2) are allocated to the Digital output.

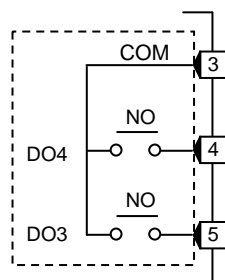
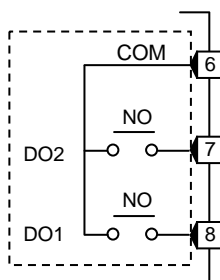

• Wiring example

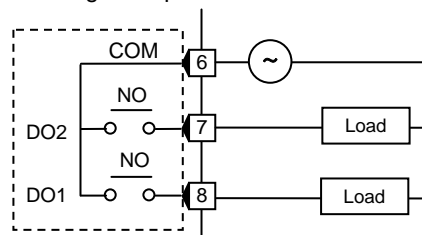

- Output type is only Relay contact output.

Relay contact output	250 V AC, 1A (Resistive load)/30 V DC, 1 A (Resistive load) 1a contact Electrical life: 300,000 times or more (Rated load)
----------------------	--

- DO1 through DO4 can be used for output of the Event function, Heater break alarm output, or FAIL (De-energized fixed: Contact opens under FAIL). Refer to page 7-79.

■ **Transmission output (AO) [optional]**

- With Transmission output (optional), terminals 35 and 36 are allocated to the Transmission output.

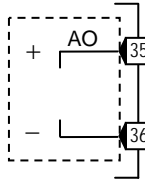

- Wiring example

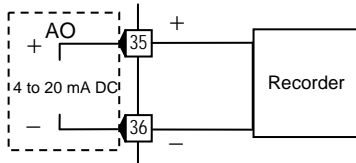

Specification code	Output type	Specifications
3	Voltage output	0 to 1 V DC (Load resistance: 1 kΩ or more)
4		0 to 5 V DC (Load resistance: 1 kΩ or more)
5		0 to 10 V DC (Load resistance: 1 kΩ or more)
6		1 to 5 V DC (Load resistance: 1 kΩ or more)
7	Current output	0 to 20 mA DC (Load resistance: 600 Ω or less)
8		4 to 20 mA DC (Load resistance: 600 Ω or less)

■ **Measured input (Thermocouple/RTD/Voltage/Current) [universal input]**

- For the Measured input type, terminals 22 through 24 are allocated to the Measured input.

Thermocouple input

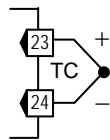

RTD input

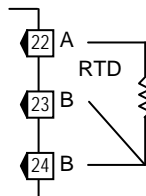

Voltage input

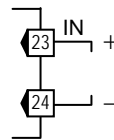

Current input

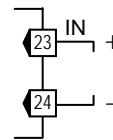

- The input types (input group) are as follows.

Input group	Input type	
Voltage (low) input group	Thermocouple	K, J, E, T, S, R, B, N, PLII, W5Re/W26Re, U, L
	RTD	Pt100, JPt100
	Voltage (low)	0 to 1 V DC, 0 to 100 mV DC, 0 to 10 mV DC, -100 to +100 mV DC, -10 to +10 mV DC
	Current	0 to 20 mA DC, 4 to 20 mA DC
Voltage (high) input group	-1 to +1 V DC, 0 to 5 V DC, 1 to 5 V DC, 0 to 10 V DC	

- For Thermocouple input, use the appropriate compensation wire.
- For RTD input, use low resistance lead wires with no difference in resistance between the three lead wires.
- To avoid noise induction, keep input signal wire away from instrument power line, load lines and power lines of other electric equipment.

■ Remote setting (RS) input [universal input]

- Remote setting (RS) input has provided as standard specifications.
- Terminal 20 and 21 are used for Remote setting (RS) input. Connect an input according to the Remote setting (RS) input type*.

* The following two methods of the RS input selection are available:
Specify when ordering (Initial setting code)
Setting by Remote setting input type of Engineering mode (refer to page 7-77)

< Initial setting code (Quick start code 2)> Any one of the following input types can be selected.

Specification code	Input type	Specification code	Input type
1	Voltage input (0 to 10 mV DC)	5	Voltage input (0 to 10 V DC)
2	Voltage input (0 to 100 mV DC)	6	Voltage input (1 to 5 V DC)
3	Voltage input (0 to 1 V DC)	7	Voltage input (0 to 20 mA DC)
4	Voltage input (0 to 5 V DC)	8	Voltage input (4 to 20 mA DC)

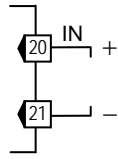

- Remote setting (RS) input is not isolated from the measured input.

■ Digital input (DI1 to DI4 [optional], DI5 to DI7 [standard])

- Terminals 30 through 34 for DI1 to DI4; and Terminals 13 through 16 for DI5 to DI7.

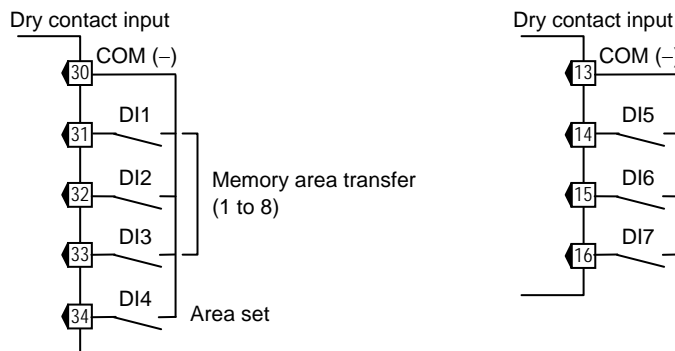

- Digital input from external devices or equipment should be dry contact input. If it is not dry contact input, the input should have meet the specifications below.

Contact specifications: At OFF (contact open): 500 kΩ or more At ON (contact closed) 10 Ω or less

- The following functions can be assigned to Digital inputs.

DI1 to DI4: Memory area transfer (Number of area: 1 to 8) + Area set

DI5 to DI7: RUN/STOP, Remote/Local transfer, Auto/Manual transfer, Interlock release

-  To assign functions to Digital inputs, refer to **7.5 Engineering Mode “Digital input assignment” (P. 7-78)**.

■ **Current transformer (CT) input/Power feed forward (PFF) input/ Feedback resistance (FBR) input [optional]**

- With Current transformer (CT) input, Power feed forward (PFF) input or Feedback resistance (FBR) input, terminals 17 through 19 are allocated to the specified input.
- When using Current transformer (CT) input, connect CTs to the relevant terminals.
- When using Power feed forward (PFF) input, connect the dedicated transformer included.
- When using Feedback resistance (FBR) input, connect a potentiometer to the relevant terminals.

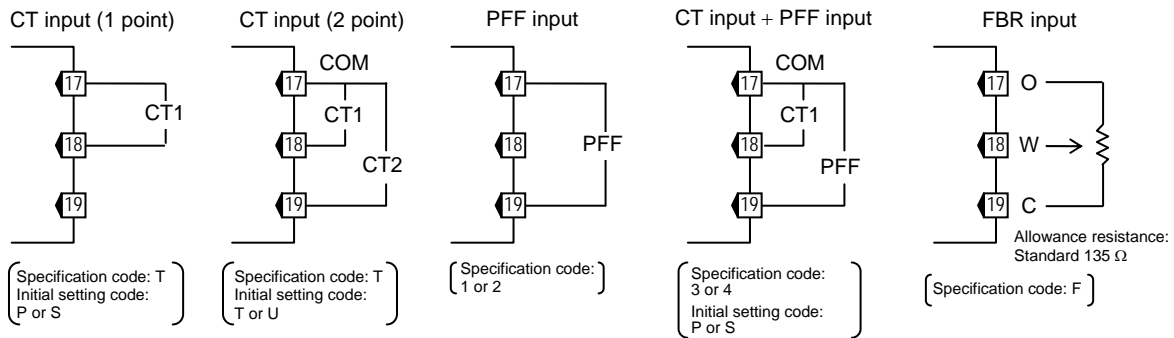

- Current transformer (CT) input, Power feed forward (PFF) input, and Feedback resistance (FBR) input are not isolated between Measured input.

■ **Communication 1/Communication 2 [optional]**

- With Communication function, terminals 25 through 29 are allocated to Communication.
- Conduct wiring to the relevant terminals meeting the specified communication interface. For details of wiring, refer to **FB400/FB900 Communication Quick Manual (IMR01N07-E□)**.

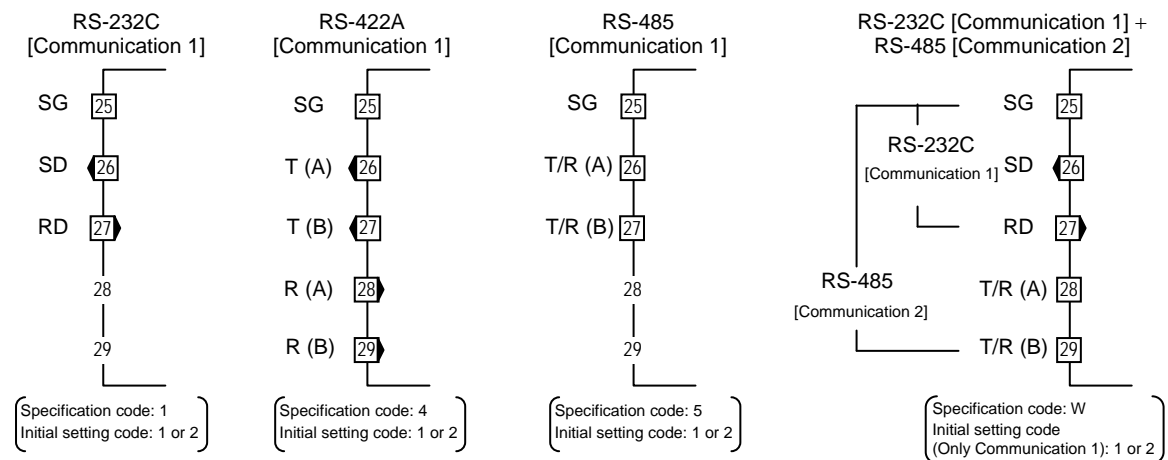

Continued on the next page.

Continued from the previous page.

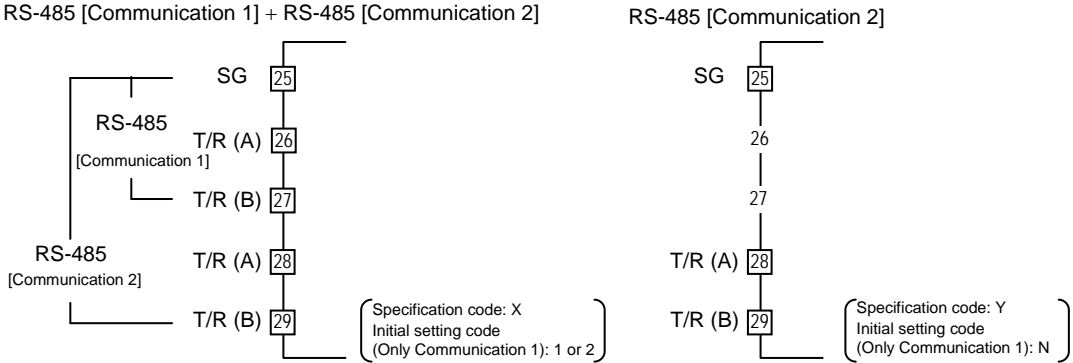

An example for the connection between Communication 1 and Host computer is shown in the following.

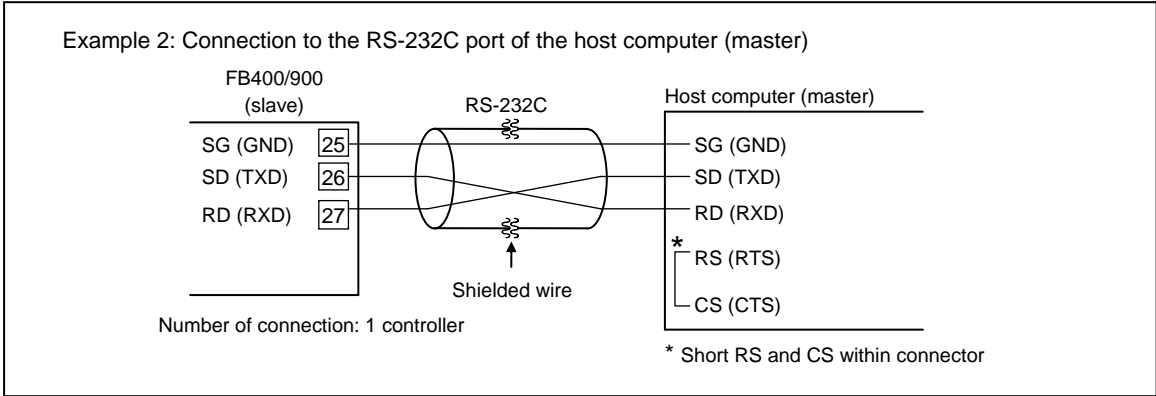
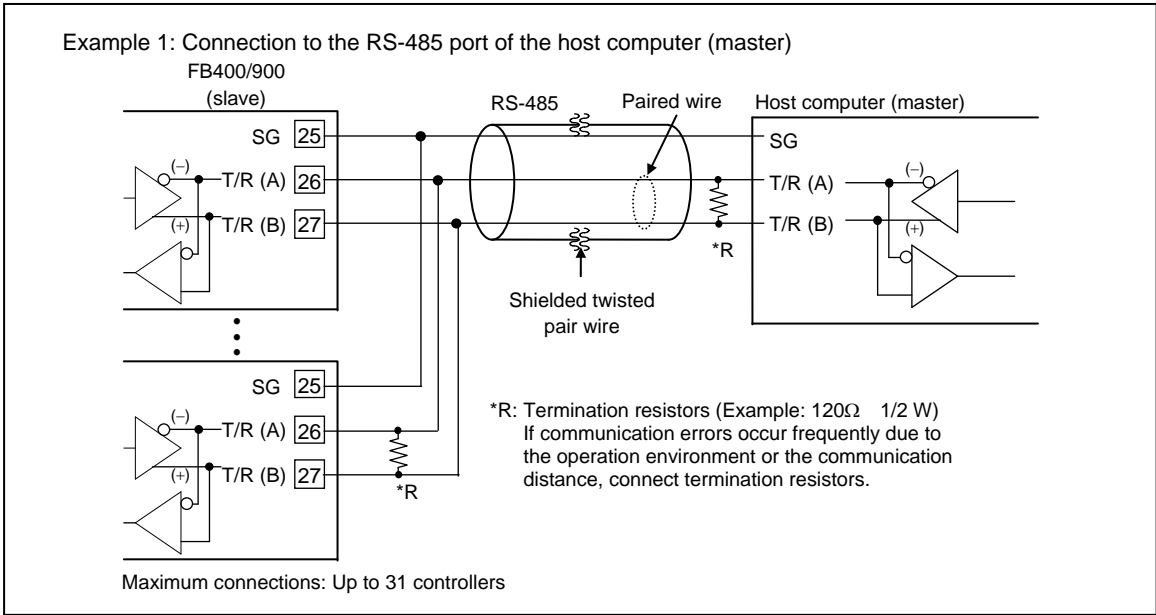

Continued on the next page.

Continued from the previous page.

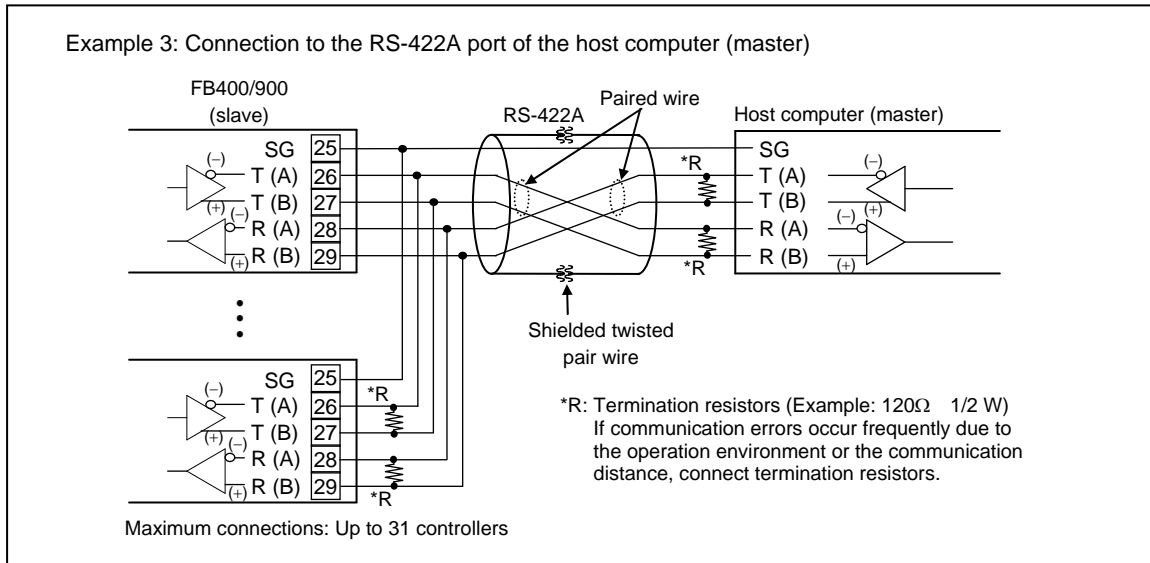

- Communication 2 function (RS-485 only) is used for the Intercontroller communication.

☞ For the Intercontroller communication, refer to **6.14 Group Operation by the Intercontroller Communication (P. 6-60)**.

4.4 Handling of the Terminal Cover [optional]

When the mounting and removing of the terminal cover, take the following steps.



WARNING

To prevent electric shock or instrument failure, always turn off the power before mounting or removing the terminal cover.



When mounting and removing the terminal cover, apply pressure very carefully for avoid damage to the terminal cover.

■ Mounting procedures

1. Check the mounting direction of the terminal cover.
2. Push the protrusions of terminal cover into the insertion slots for mounting the terminal cover.

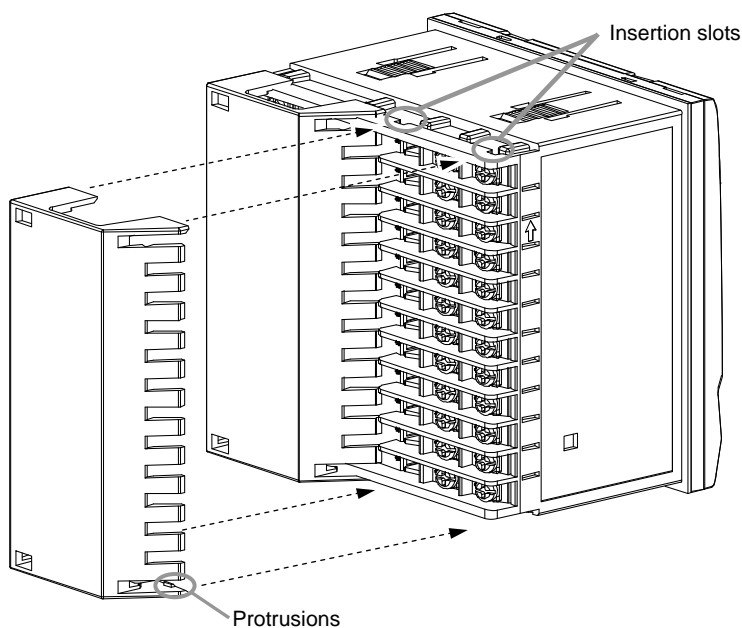

Terminal cover

Parts code	KFB400-58(3)
Ordering code	00491465

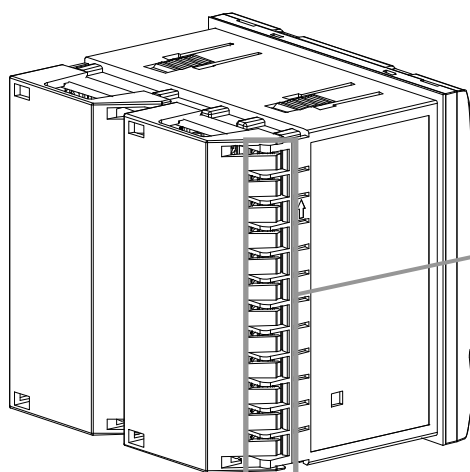

With the terminal cover fixed to FB900

- With the terminal cover to FB400

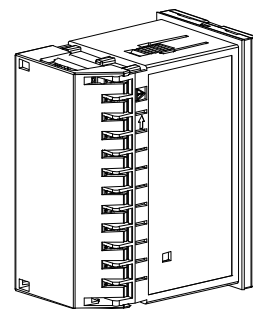

■ **Removing procedures**

Release the protrusions of terminal cover from the insertion slots (①) shown in the following figure, and then pull the terminal cover (②) to remove it from the case.

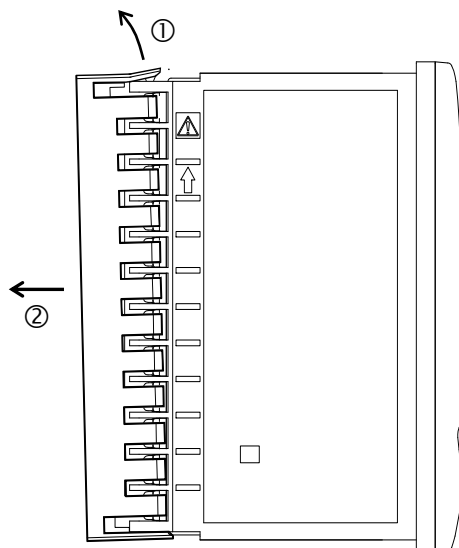

OPERATION MENU AND BASIC OPERATION





- 5.1 Operation Menu5-2
- 5.2 Basic Operation5-4
 - 5.2.1 Scrolling through parameters5-4
 - 5.2.2 Changing Set value (SV).....5-8
 - 5.2.3 Operation of the direct keys5-9
 - 5.2.4 Data lock function.....5-10

5.1 Operation Menu

The FB Series has five different setting modes. All settable parameters belong to one of them. The following chart shows how to access different setting mode.

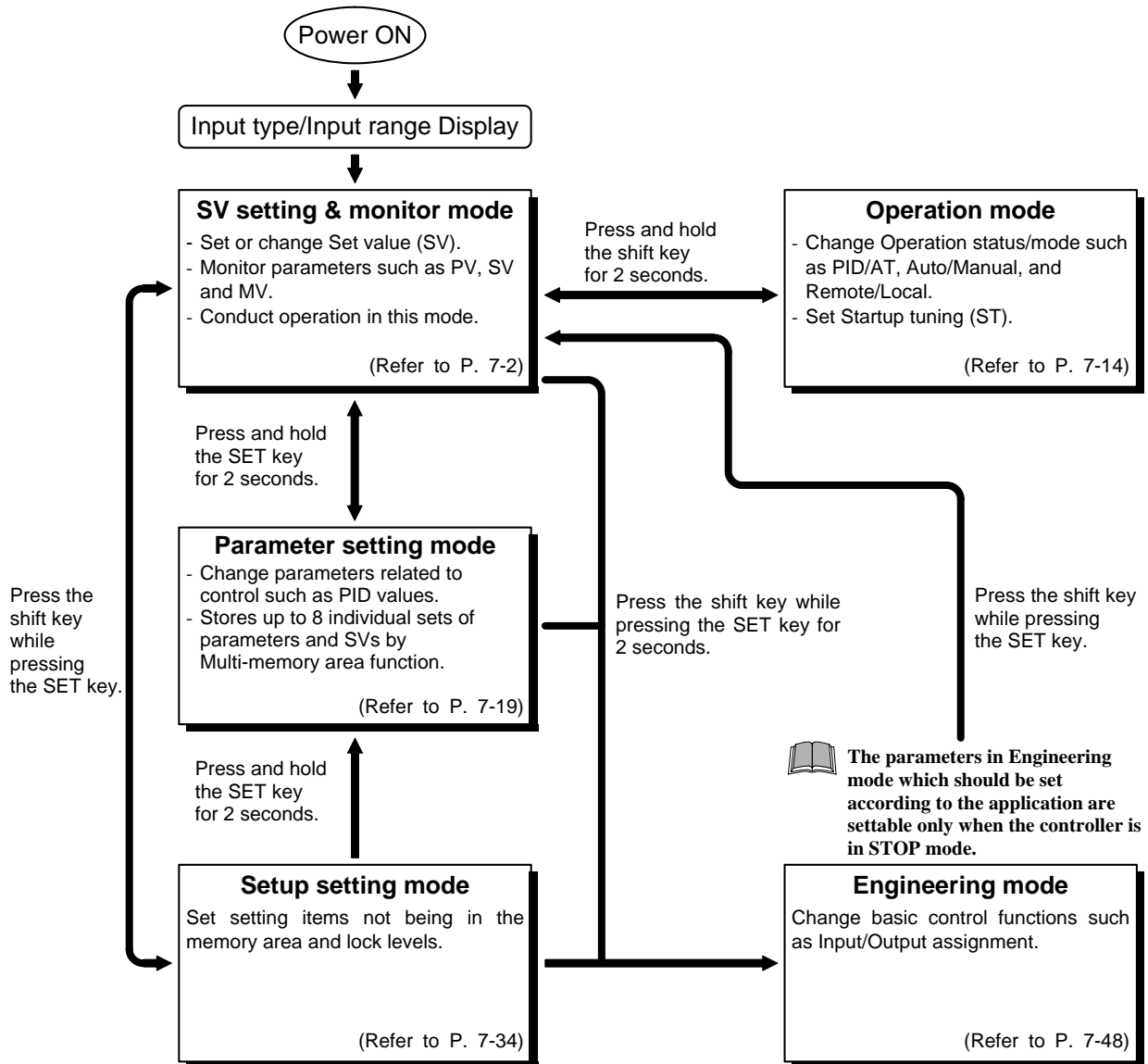
 For the details of key operation, refer to **5.2 Basic Operation (P. 5-4)**.



 Display returns to the SV setting and monitor mode from the Operation mode or the Parameter setting mode by pressing the shift key while pressing the SET key.

 Display returns to the Measured value (PV)/Set value (SV) monitor screen if no key operation is performed within 1 minute (except during the Feedback adjustment or the Power feed forward input value monitor display).

 Parameters not being specified are not displayed except in the Engineering mode.

■ Input type and input range display

This instrument immediately confirms inputs type symbol and input range following power ON.

Example: When sensor type is K thermocouple

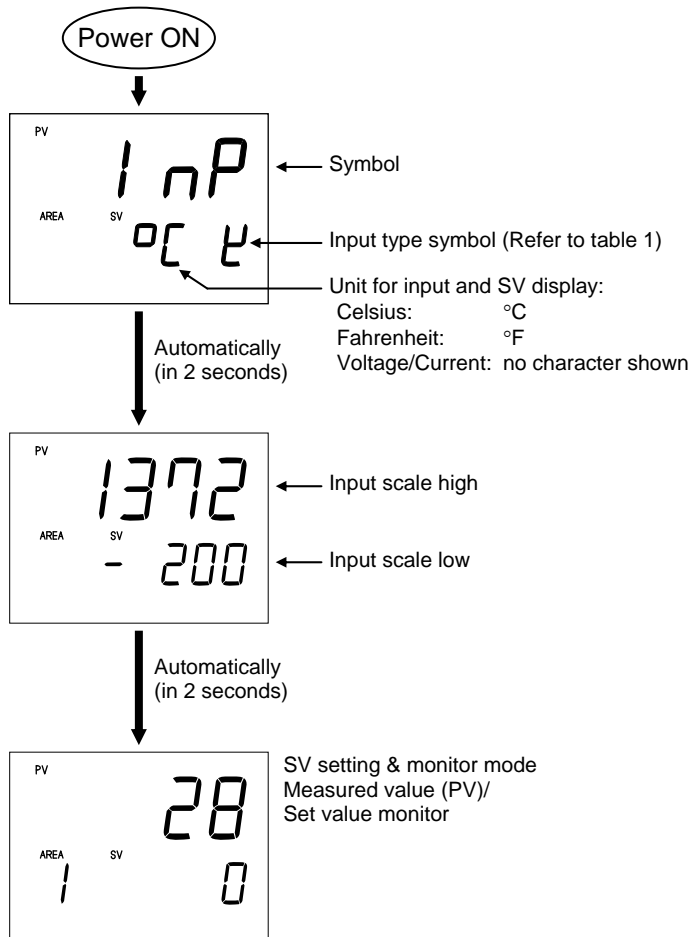

Table 1: Input type symbol table

Symbol	Input type
K	Thermocouple K
J	Thermocouple J
T	Thermocouple T
S	Thermocouple S
R	Thermocouple R
E	Thermocouple E
B	Thermocouple B
N	Thermocouple N
P	Thermocouple PLII
W	Thermocouple W5Re/W26Re
U	Thermocouple U
L	Thermocouple L
Pt	RTD Pt100
JP	RTD JPt100
V	Voltage (mV, V)
I	Current (mA)

5.2 Basic Operation

Basic key operations common to each mode (set item change, set value change and registration) and Data lock function are described in the following.

5.2.1 Scrolling through parameters

■ SV setting & monitor mode

Operation method for SV setting & monitor mode differs depending on the Direct key type. The two key types of the Type 1 and Type 2 are available. The Direct key type can be selected in the Engineering mode.

(1) When the Direct key type is Type 1:

- Pressing the MONI key enables the selection of only monitor screens in SV setting & monitor mode. To go back to the first parameter, keep pressing MONI keys until it is displayed again.
- Pressing the SET key enables the selection of only setting screens in SV setting & monitor mode. To go back to the first parameter, keep pressing SET keys until it is displayed again.
- Pressing the AREA key changes to the Memory area transfer screen. Pressing the SET key returns to the Measured value (PV)/Set value (SV) monitor screen.

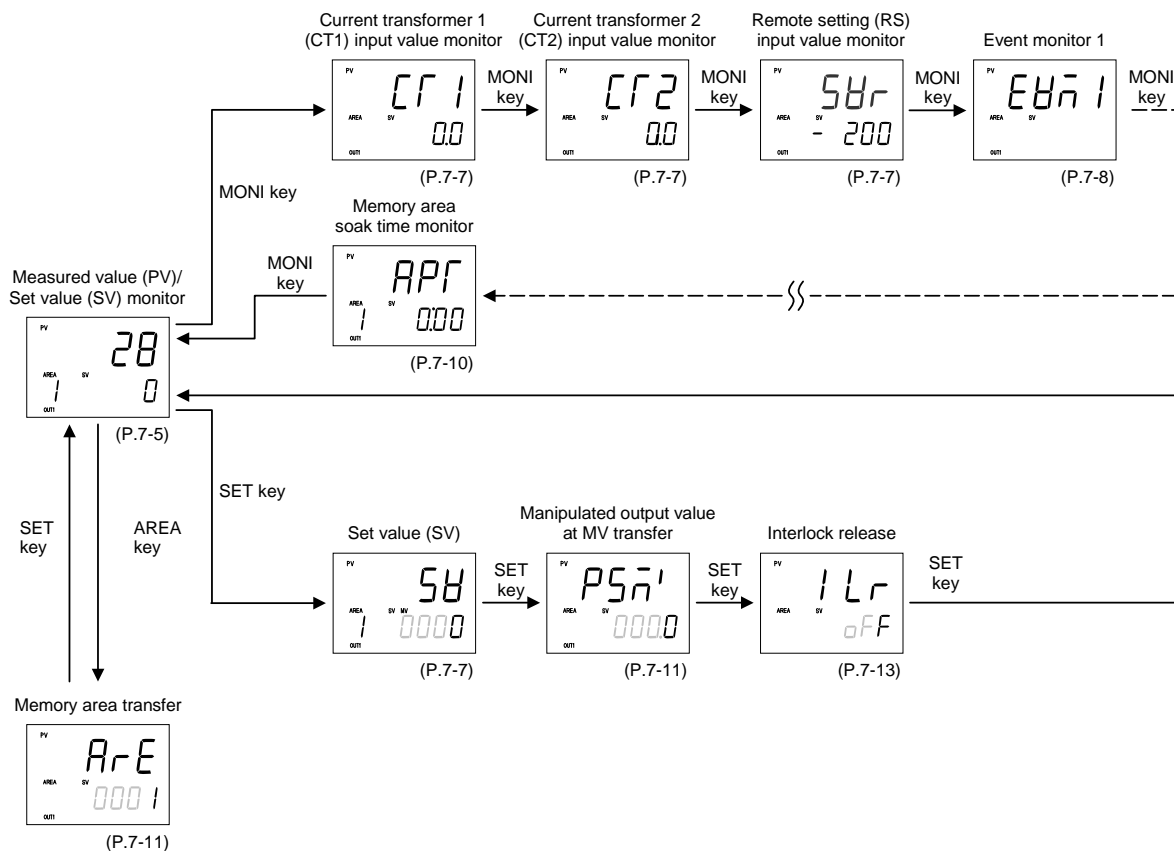

(2) When the Direct key type is Type 2:

The monitoring, setting and Memory area transfer screen are mixedly displayed.

- Pressing the SET key enables screen selection.
- To go back to the first parameter, keep pressing SET keys until it is displayed again.

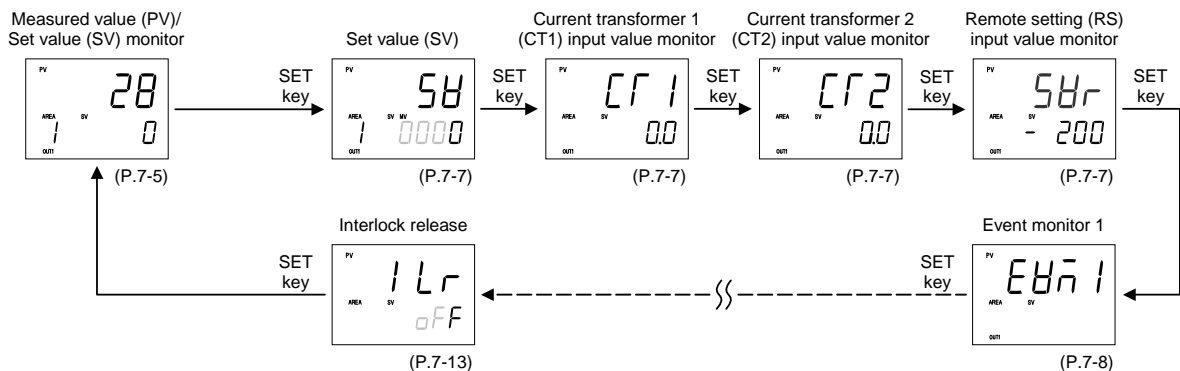

■ Parameter setting mode, Setup setting mode

- Press to scroll through parameters in the same mode/area.
- To go back to the first parameter, keep pressing SET keys until it is displayed again.
- If the type of Direct key is of Type 1, pressing the MONI key is changed to the Measured value (PV)/Set value (SV) monitor screen.

Parameter setting mode

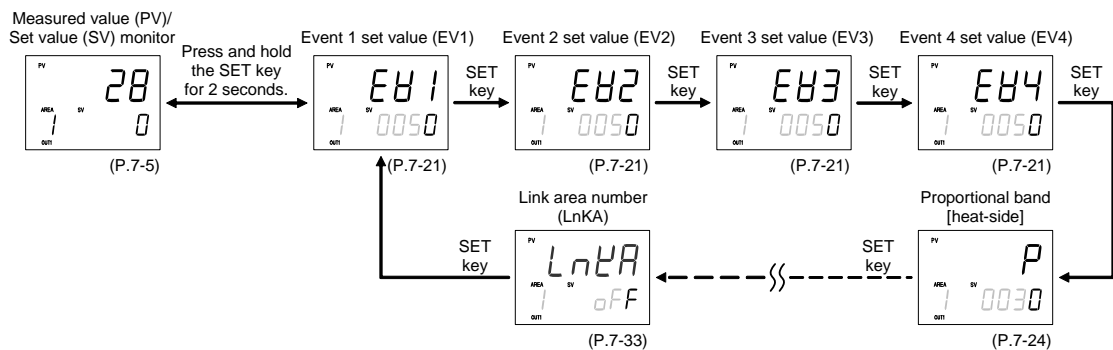

Setup setting mode

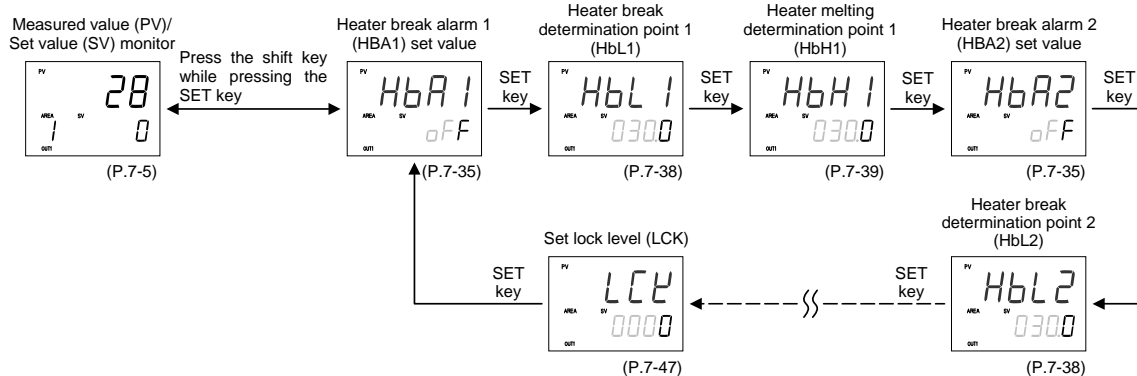

■ Operation mode

- Pressing the shift or SET key enables screen selection.
- To go back to the first parameter, keep pressing shift keys until it is displayed again.
- Pressing the UP or DOWN key enables operation mode selection.
- If the type of Direct key is of Type 1, pressing the MONI key is changed to the Measured value (PV)/Set value (SV) monitor screen.

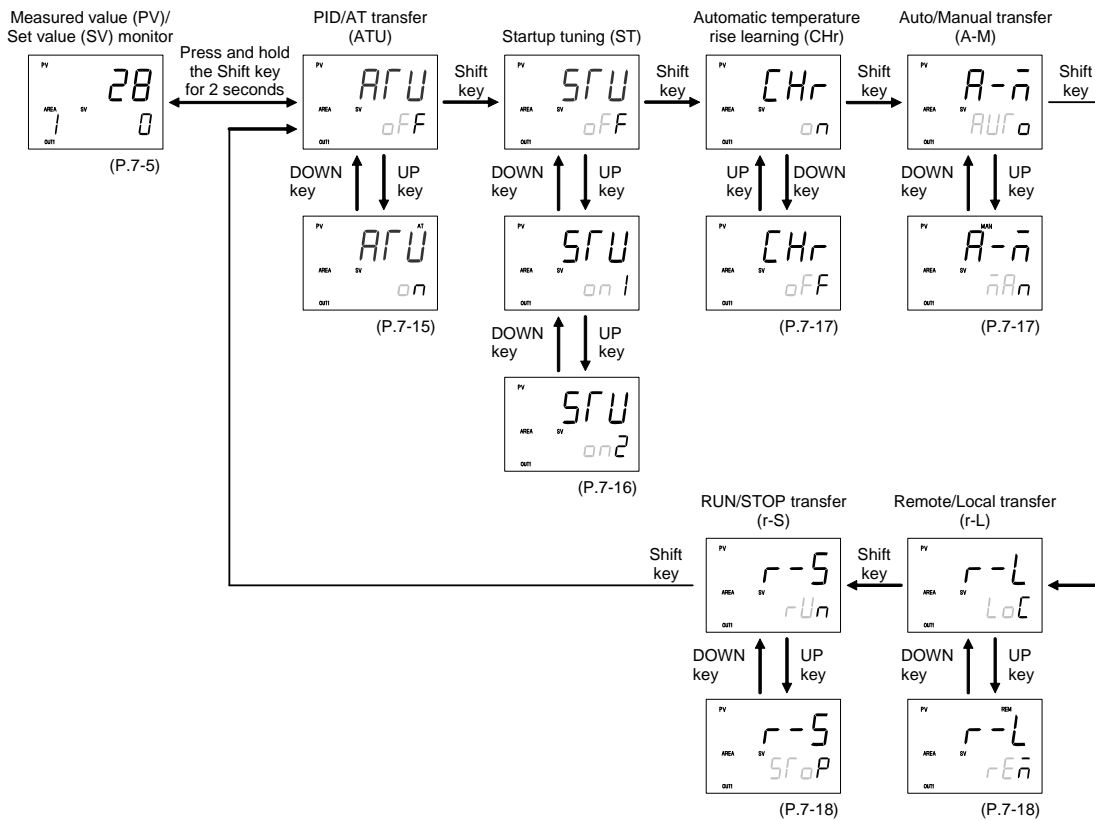

Transferring the Operation mode immediately performs control in the mode transferred.

■ Engineering mode

- Pressing the UP or DOWN key enables function block selection.
- Pressing the SET key enables parameter selection.
- To go back to the first parameter, keep pressing UP or DOWN keys until it is displayed again.
- If the type of Direct key is of Type 1, pressing the MONI key is changed to the Measured value (PV)/Set value (SV) monitor screen.

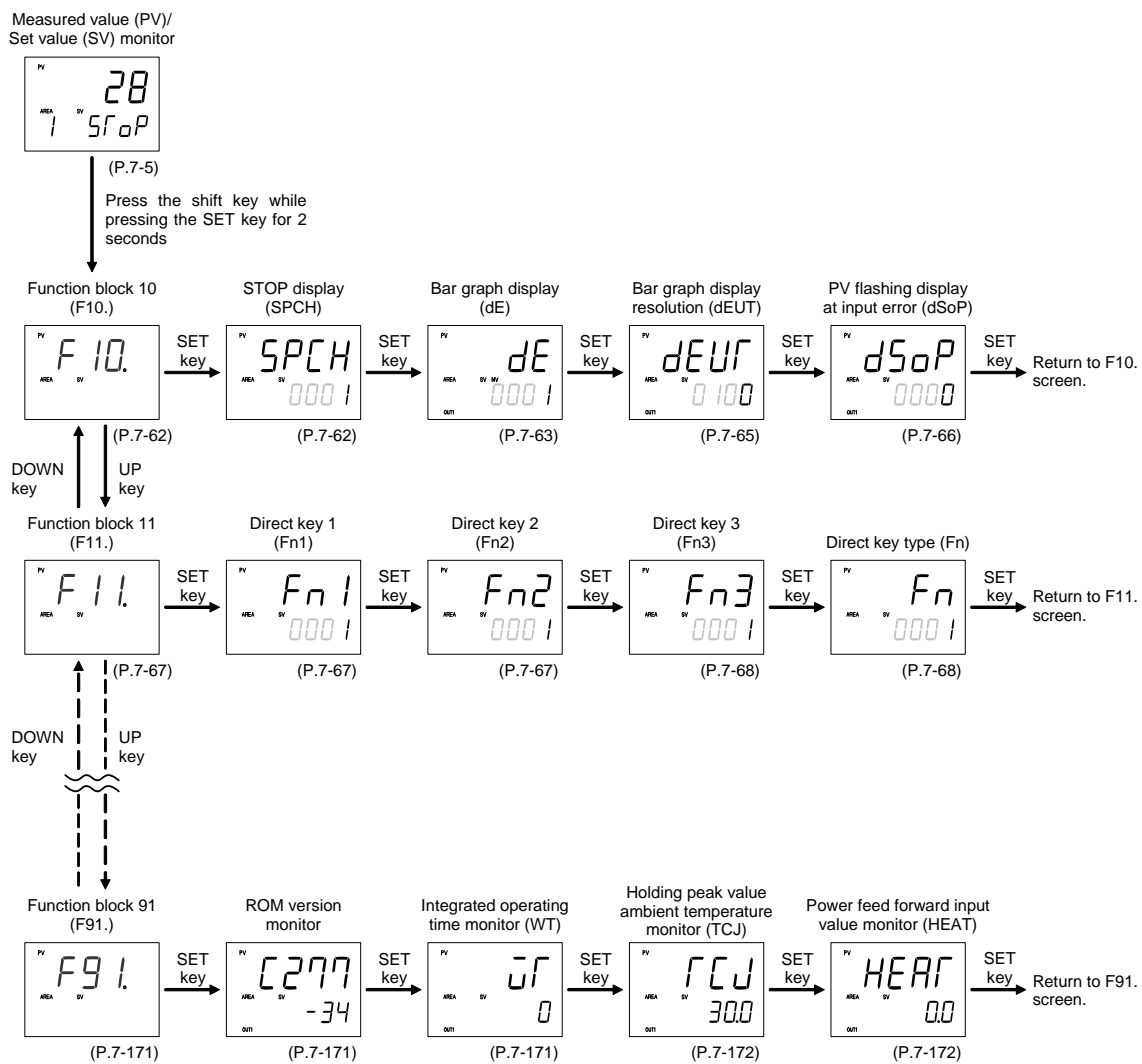

5.2.2 Changing Set value (SV)

- The high-lighted digit indicates which digit can be set. Press Shift key to go to a different digit. Every time the shift key is pressed, the high-lighted digit moves as follows.



- The following is also available when changing the set value.

Increase SV from 199 °C to 200 °C:

- Press the shift key to light brightly the ones place (first digit from the right).
- Press the UP key to change to 0.
The display changes to 200.

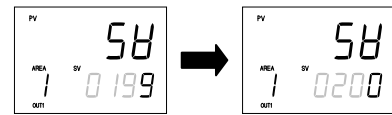

Decrease SV from 200 °C to 190 °C:

- Press the shift key to light brightly the tens place.
- Press the DOWN key to change to 9.
The display changes to 190.

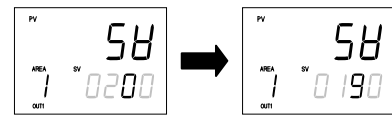

Decrease SV from 200 °C to -100 °C:

- Press the shift key to light brightly the hundreds place.
- Press the DOWN key (three times) to change to -1.
The display changes to -100.

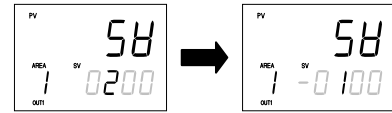

- To store a new value for the parameter, always press the SET key.** The display changes to the next parameter and the new value will be stored.



A new value will not be stored without pressing SET key after the new value is displayed on the display.



After a new value has been displayed by using the UP and DOWN keys, the SET key must be pressed within 1 minute, or the new value is not stored and the display will return to the Measured value (PV)/Set value (SV) monitor screen.

5.2.3 Operation of the direct keys

■ Direct key type

The two Direct key types of the Type 1 and Type 2 are available. The Direct key type can be selected in the Engineering mode. (Refer to P. 7-68)

The type of Direct key is set to Type 1 before factory shipment. If the type of direct key is changed to Type 2, stick an attached seal to the front surface of the instrument.

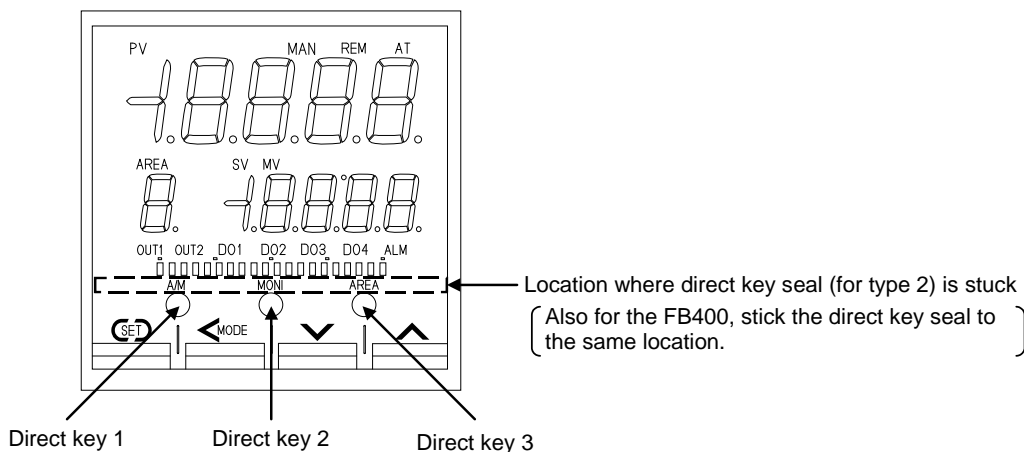

Direct key type	Direct key 1	Direct key 2	Direct key 3
Type 1	A/M transfer key	MONI key	AREA key
Type 2	A/M transfer key	R/L transfer key	R/S transfer key

A/M: Auto/Manual

R/L: Remoter/Local

R/S: RUN/STOP

■ How to restrict operation of the direct keys

Three Direct function keys on the front panel are provided for one-key operation to switch Auto/Manual, Monitor screen (or Remote/Local), and Memory area (or RUN/STOP). Use/Unuse of Direct keys is settable in Engineering mode (function block 11). (Refer to P. 7-67)

5.2.4 Data lock function

The Data lock function limits access of unauthorized personnel to the parameters and prevents parameter change by mistake.

There are 8 set data lock levels. The set Data lock level can be set in Setup setting mode.

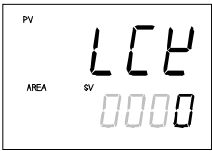
Character display	Parameters which can be changed	Set value
	All parameters [Factory set value]	0000
	<ul style="list-style-type: none"> • Set value (SV) • Event set value (EV1 to EV4) • Memory area transfer • Manipulated output value at MV transfer • Parameters in Operation mode • Parameters in F10 through F91 	0001
	All parameters except for Event set value 1 (EV1) to Event set value 4 (EV4)	0010
	Set value (SV)	0011
	All parameters except for Set value (SV)	0100
	Event set value (EV1 to EV4)	0101
	All parameters except for Set value (SV) and Event set value (EV1) to Event set value (EV4)	0110
	No parameter (All Locked)	0111



Data lock level can be changed in both RUN and STOP mode.



Parameters protected by Data lock function are still displayed for monitoring.

OPERATION

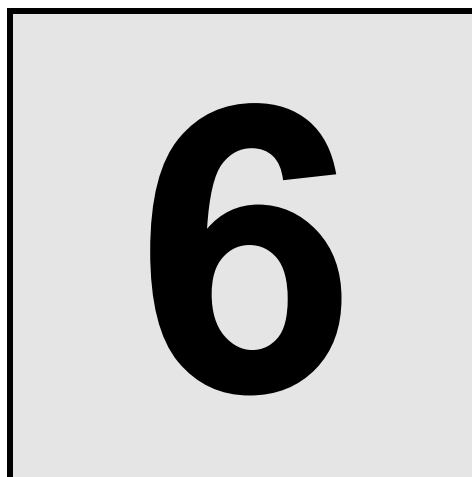

6.1	Operating Precautions.....	6-2
6.2	Monitoring Display in Operation	6-3
6.3	Operating Setting	6-5
6.3.1	Set the Set value (SV).....	6-5
6.3.2	Set the Event set value (alarm set value)	6-6
6.3.3	Autotuning (AT) start	6-8
6.4	RUN/STOP Transfer	6-11
6.5	Autotuning (AT)	6-15
6.6	Startup Tuning (ST).....	6-18
6.7	Auto/Manual Transfer.....	6-23
6.8	Remote/Local Transfer.....	6-28
6.9	Control Area Transfer.....	6-32
6.10	Interlock Release.....	6-36
6.11	Start Action at Recovering Power Failure.....	6-39
6.12	Position Proportioning PID Control.....	6-40
6.13	Ramp/Soak Control.....	6-50
6.14	Group Operation by the Intercontroller Communication	6-60
6.14.1	Wiring method of the Intercontroller communication	6-60
6.14.2	Common setting of the Intercontroller communication	6-61
6.14.3	Group RUN/STOP function	6-63
6.14.4	Automatic temperature rise function (with learning function)	6-72
6.14.5	Cascade control function.....	6-82
6.14.6	Ratio setting function.....	6-91

6.1 Operating Precautions

Check the following items before starting operation, then turn on the power.

■ Power ON

There is no power switch on this instrument, and the instrument starts operation immediately following initial power ON (Factory set value: RUN).

■ Action at input error

If the input signal wiring is disconnected or short-circuited (RTD input only), the instrument determines that burnout has occurred.

● Burnout direction

Upscale: Thermocouple input¹, RTD input (at input break), Voltage (low) input

Downscale: Thermocouple input¹, RTD input (at short-circuited), Voltage (low) input, Voltage (high) input², Current input²

¹ For the Thermocouple input, upscale or downscale can be selected by Engineering mode. (Factory set value: Upscale)

² For the Voltage (high) input or the Current input, the display becomes indefinite (display of about zero value).

● Output at input error

Control output: According to the contents set by Action (high/low) at input error

Event output: According to the contents set by Event action at input error

■ Checking the each parameter

The settings for the SV and all parameters should be appropriate for the controlled system.

There are parameters in Engineering mode which can not be changed when the controller is in RUN mode. Change the RUN/STOP mode from RUN to STOP when a change for the parameters in Engineering mode is necessary.

 For details of the each parameter, refer to **7. DESCRIPTION OF EACH PARAMETER (P. 7-1)**.

 For details of RUN/STOP transfer, refer to **6.4 RUN/STOP Transfer (P. 6-11)**.

 For details of the parameter in Engineering mode, refer to **7.5 Engineering Mode (P. 7-48)**.

■ Operation when power failure

A power failure of 20 ms or less will not affect the control action. When a power failure of more than 20 ms occurs the instrument assumes that the power has been turned off. When the power returns, the operation of instrument will be re-starts in accordance with the content selected by Hot/Cold start.

 For details of Hot/Cold start, refer to **6.11 Start Action at Recovering Power Failure (P. 6-39)**.

■ Event hold action

- The event hold action is activated when the power is turned on or when transferred from STOP mode to RUN mode.
- The event re-hold action is activated when not only the SV is changed, but also the power is turned on or when transferred from STOP mode to RUN mode.

6.2 Monitoring Display in Operation

In SV setting & monitor mode, the following operations are possible.

When the power is turned on, the controller goes to this mode after self-diagnostics. Use this mode during normal operation. Selection method of monitor screens for SV setting & monitor mode differs depending on the Direct key type (Type 1, Type 2).

 The factory set value of the Direct key type is Type 1 (A/M, MONI, AREA).

 For the Direct key operation, refer to **5.2.3 Direct key operation (P. 5-9)**.

■ Direct key type 1

- Pressing the MONI key enables the selection of only monitor screens in SV setting & monitor mode.
- To go back to the first parameter, keep pressing MONI keys until it is displayed again.

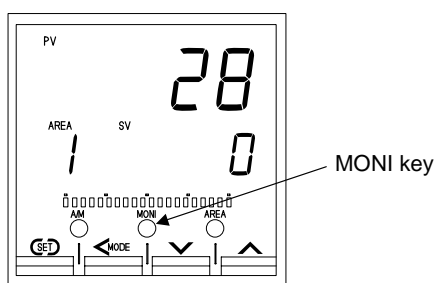

- Display sequence of SV setting & monitor mode:

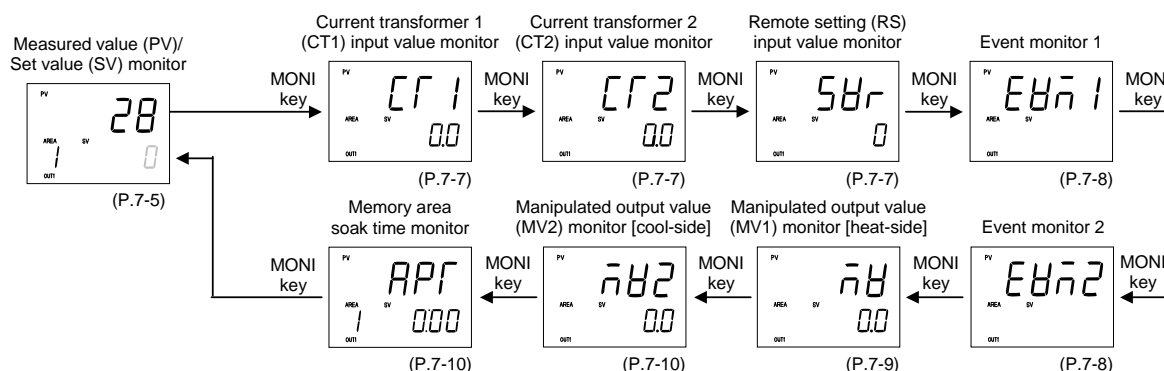

 For the content of each screen, refer to **7.1 SV setting & Monitor Mode (P. 7-2)**.

 Parameters which are not related to existing functions on the controller or not specified functions are not displayed as shown in the following.

- Current transformer 1 (CT1) input value monitor and Current transformer 2 (CT2) input value monitor screens are not displayed if the CT inputs are not specified.
- Manipulated output value (MV1) monitor [heat-side] screen is not displayed if the Feedback resistance (FBR) input is not used for Position proportioning PID control.
- The valve position from the control motor is displayed on Manipulated output value (MV1) monitor [heat-side] screen if the Feedback resistance (FBR) input is used for Position proportioning PID control.
- Manipulated output value (MV2) monitor [cool-side] screen is displayed if the Heat/Cool PID control is selected as control action.

■ Direct key type 2

- Pressing the SET key enables the selection of screens.
- Monitor screens, Setting screens, and Memory area screen can be displayed.
- To go back to the first parameter, keep pressing SET keys until it is displayed again.

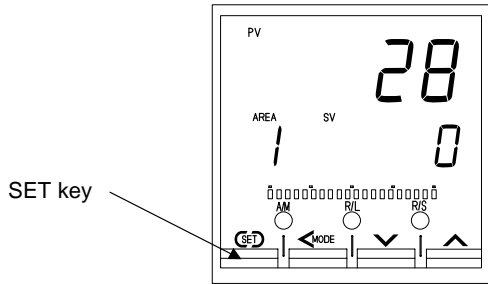

- Display sequence of SV setting & monitor mode:

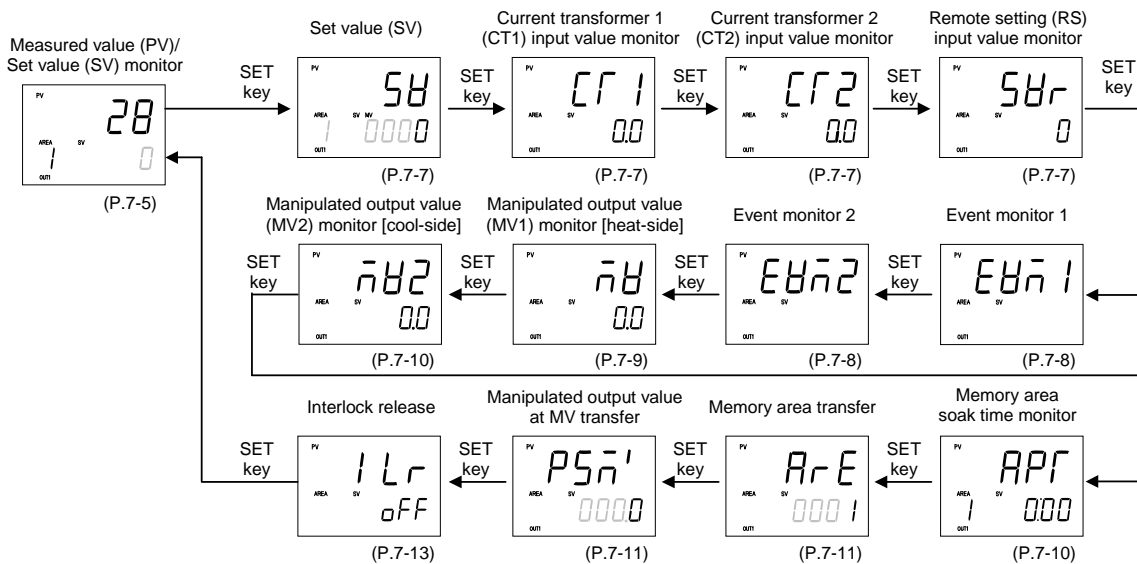

For the content of each screen, refer to **7.1 SV setting & Monitor Mode (P. 7-2)**.

Parameters which are not related to existing functions on the controller or not specified functions are not displayed as shown in the following.

- Current transformer 1 (CT1) input value monitor and Current transformer 2 (CT2) input value monitor screens are not displayed if the CT inputs are not specified.
- Manipulated output value (MV1) monitor [heat-side] screen is not displayed if the Feedback resistance (FBR) input is not used for Position proportioning PID control.
- The valve position from the control motor is displayed on Manipulated output value (MV1) monitor [heat-side] screen if the Feedback resistance (FBR) input is used for Position proportioning PID control. If the Feedback resistance (FBR) input is disconnected, the input value goes to over-scale (“□□□□” display).
- Manipulated output value (MV2) monitor [cool-side] screen is displayed if the Heat/Cool PID control is selected as control action.
- Manipulated output value at MV transfer screen is not displayed if the MV transfer function is set to “0.”
- Interlock release screen is not displayed if the Event interlock is set to “Unused.”

6.3 Operating Setting

An example of performing operation with SV set to 200 °C and Event 1 set value [deviation high] set to 20 °C is shown in the following.

■ Operation procedures

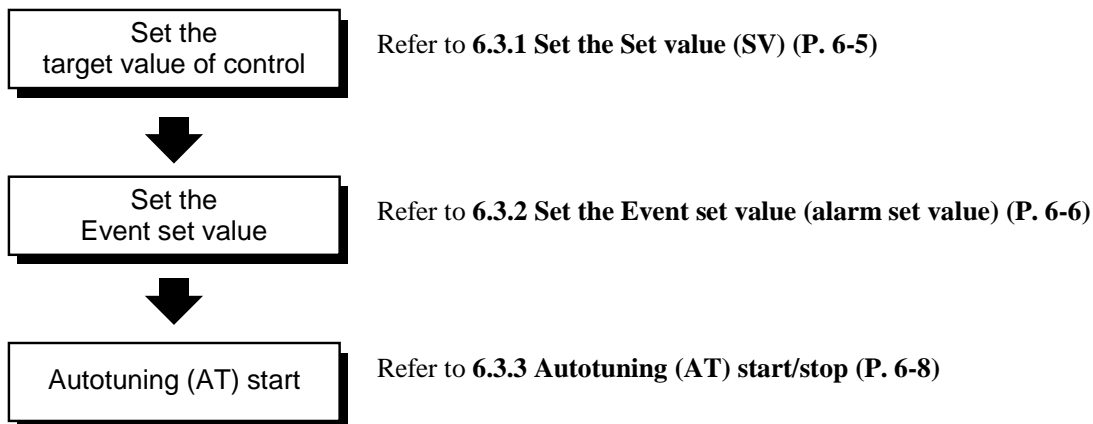

6.3.1 Set the Set value (SV)

Example: Change the target value of the control to 200 °C

1. Select the Set value (SV) screen

Press the SET key at PV/SV monitor screen until Set value (SV) screen is displayed.

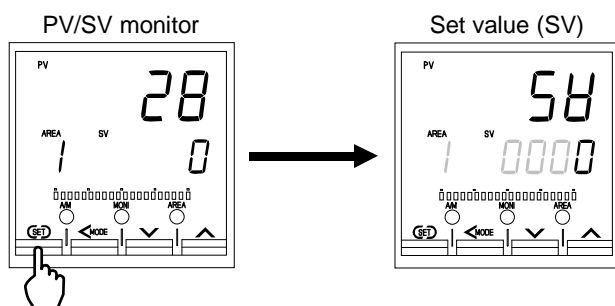

2. Change the Set value (SV)

The set value is set to 200 °C by using the Shift and UP keys. The high-lighted digit indicates which digit can be set.

- ① Press the Shift key to high-light the hundreds digit.
- ② Press the UP key to change the number to 2.

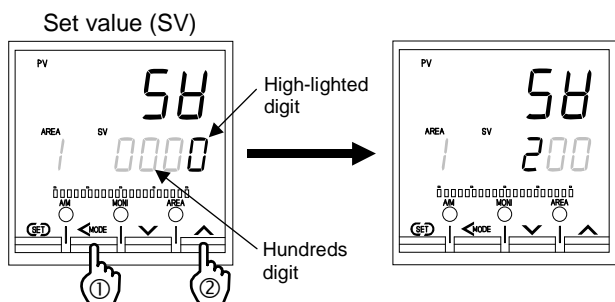

3. Store the set value (SV)

Press the SET key to store the new Set value (SV). The screen goes to the next parameter.

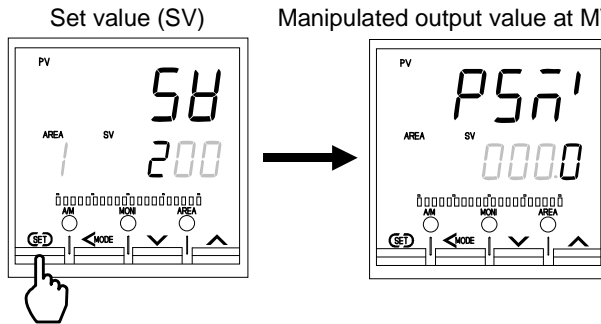

The parameter that appears next after Set value (SV) varies depending on the specifications.



After a new value is displayed on the display by using UP and DOWN keys, if no key operation is performed within 1 minute without pressing SET key, this instrument returns to the PV/SV monitor screen and the Set value (SV) will not be changed.

4. Return the PV/SV monitor

To return the PV/SV monitor, press the MONI key (for Direct key Type 1), or press the SET key several times.

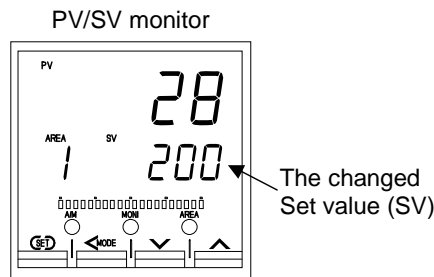

6.3.2 Set the Event set value (alarm set value)

Example: Change the Event 1 set value (EV1) to 20 °C

1. Select the Event 1 set value (EV1) screen

Press and hold the SET key for 2 seconds at PV/SV monitor screen until Parameter setting mode is displayed. Event 1 set value (EV1) is displayed first.

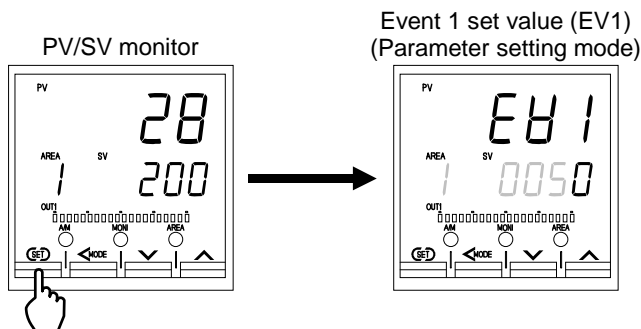

Event set value screen is not displayed when the event function is not available.

2. Change the Event 1 set value (EV1)

The Event 1 set value (EV1) is set to 20 °C by using the Shift and DOWN keys. The high-lighted digit indicates which digit can be set.

- ① Press the Shift key to high-light the tens digit.
- ② Press the DOWN key to change the number to 2.

Event 1 set value (EV1)

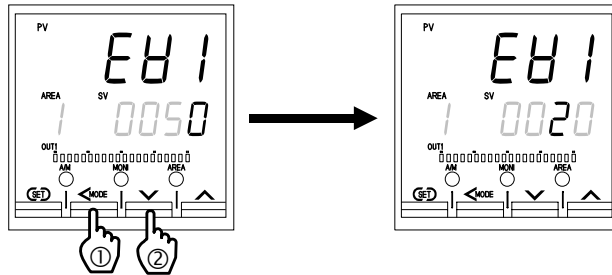

3. Store the new Event 1 set value (EV1)

Press the SET key to store the new Event 1 set value (EV1). The screen goes to the next parameter.

Event 1 set value (EV1)

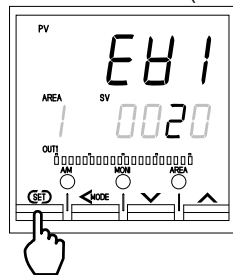

Event 2 set value (EV2) [When the event 2 is used]

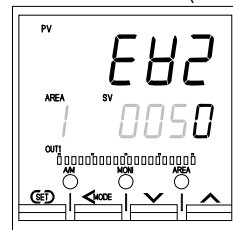

After a new value is displayed on the display by using UP and DOWN keys, if no key operation is performed within 1 minute without pressing SET key, this instrument returns to the PV/SV monitor screen and the Event 1 set value (EV1) will not be changed.

4. Return the PV/SV monitor

To return the PV/SV monitor, press the MONI key (for direct key type 1), or press and hold the SET key for 2 seconds.



For details of the event function, refer to **7.5 Engineering Mode (P. 7-85 to P. 7-115)**.

6.3.3 Autotuning (AT) start

Autotuning (AT) automatically measures, computes and sets the optimum PID values.

-  Check that all of the requirements for AT start are satisfied before starting operation (refer to P. 6-15). To start Autotuning (AT), go to PID/AT transfer in Operation mode.

1. Select the PID/AT transfer screen

Press and hold the Shift key for 2 seconds at PV/SV monitor screen until Operation mode is displayed. PID/AT transfer screen is displayed first.

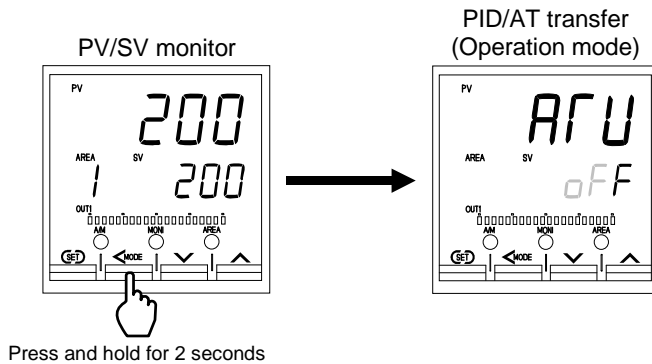

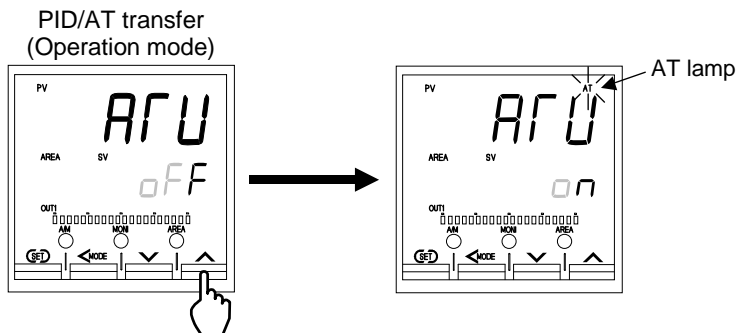

2. Start the Autotuning (AT)

If set to “on” by pressing the UP key, the Autotuning function (AT) starts. At this time, the AT lamp flashes.



3. Autotuning (AT) finish

When the Autotuning (AT) is finished, the control will automatically return to PID control. At this time, the AT lamp turns off.

-  When canceling the Autotuning function (AT), press the DOWN key to be set to “oFF.”
-  To return the PV/SV monitor, press the MONI key (for Direct key Type 1), or press and hold the Shift key for 2 seconds.
-  If Autotuning (AT) ends normally, the LBA time is automatically set twice as large as the Integral time.

■ To manually set PID values

If the autotuning function does not match the controlled object requirements, the optimum PID values may not be computed by Autotuning (AT). In that case, adjust the PID values manually.

● Setting procedure

1. Select the Parameter setting mode

Press and hold the SET key for 2 seconds at PV/SV monitor screen until Parameter setting mode is displayed. Event 1 set value (EV1) is displayed first.

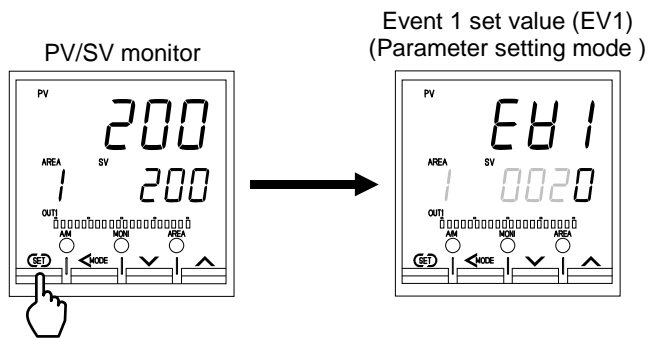

Press and hold for 2 seconds



Event set value screen is not displayed when the event function is not available.

2. Select the Proportional band [heat-side] screen

Press the SET key several times to change to the Proportional band [heat-side] screen.

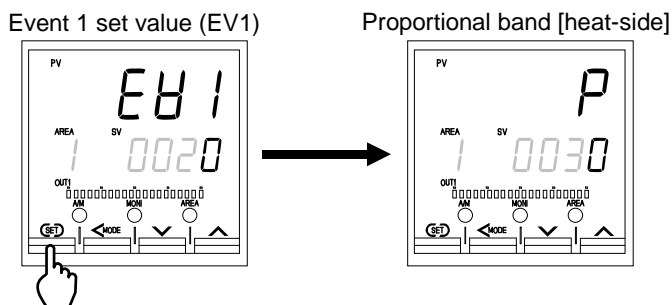

3. Change the Proportional band [heat-side] set value

The Proportional band [heat-side] set value is set to 10 °C by using the Shift and DOWN keys (Example: 10 °C).

The high-lighted digit indicates which digit can be set.

- ① Press the Shift key to high-light the tens digit.
- ② Press the DOWN key to change the number to 1.

Proportional band [heat-side]

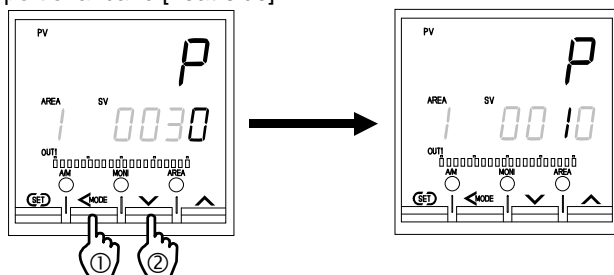

4. Store the Integral time [heat-side] set value

Press the SET key to store the new Proportional band [heat-side] set value.

The screen goes to the next Integral time [heat-side].

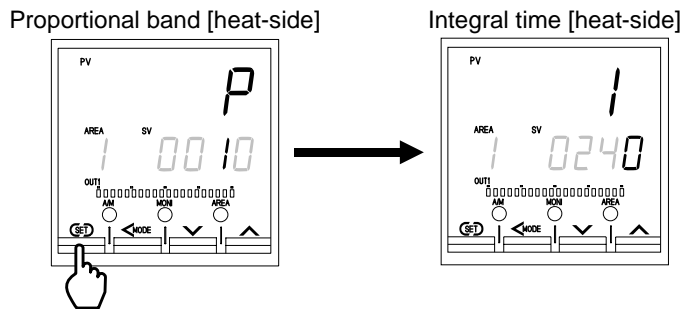

After a new value is displayed on the display by using UP and DOWN keys, if no key operation is performed within 1 minute without pressing SET key, this instrument returns to the PV/SV monitor screen and the Proportional band [heat-side] set value will not be changed.

5. Set the Integral time [heat-side] and Derivative time [heat-side]

The setting procedure applies when the Integral time [heat-side] and the Derivative time [heat-side] are also set.

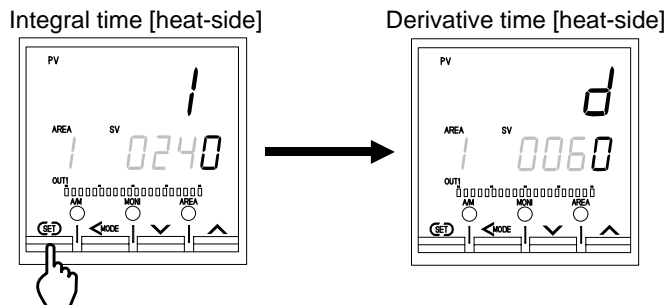

6. Return the PV/SV monitor

To return the PV/SV monitor, press the MONI key (for direct key type 1), or press and hold the SET key for 2 seconds.



For the setting range of PID values, refer to **7.3 Parameter Setting Mode (P. 7-24 to P. 7-25)**.

6.4 RUN/STOP Transfer

The RUN/STOP transfer can be made by Digital input (DI) or Communication (optional) other than the key operation.

 **When the digital input RUN/STOP transfer function is used, it is impossible to transfer RUN/STOP through key operation if the contact (DI5) is not closed. (When DI5 opens: STOP mode is maintained.)**

 For details of the RUN/STOP transfer by Communication, refer to the separate **FB100/FB400/FB900 Communication Instruction Manual (IMR01N04-E□)**.

● State of this instrument when set to STOP mode

STOP display	Displays the STOP symbol “SToP” on the SV or PV displays. (Factory set value: SV displays)	
Control output	PID control	Output depending on the Manipulated output value (MV1) at STOP mode (Factory set value: -5.0 %)
	Heat/Cool PID control	Heat-side: Output depending on the Manipulated output value (MV1) at STOP mode (Factory set value: -5.0 %) Cool-side: Output depending on the Manipulated output value (MV2) at STOP mode (Factory set value: -5.0 %)
	Position proportioning PID control	When there is no Feedback resistance (FBR) input: Conform to the set value of the Valve action at STOP mode. When there is Feedback resistance (FBR) input: Manipulated output value (MV) at STOP mode corresponds to Feedback resistance (FBR) input value. When there is Feedback resistance (FBR) input, and it is input break: Conform to the set value of the Valve action at STOP mode.
Event output	Output depending on the output status at STOP mode (Factory set value: OFF)	
HBA output		
Transmission output		

 For the settings of STOP display, Output status at STOP mode, and Manipulated output value (MV) at STOP mode, refer to **7.5 Engineering Mode (P. 7-62, P. 7-82 and P. 7-136)**.

● State of this instrument when set to RUN mode

Operation when transferred to RUN from STOP is in accordance with the Hot/Cold start selection setting.

 For the Hot/Cold start selection, refer to **6.11 Start Action at Recovering Power Failure (P. 6-39)**.

■ RUN/STOP transfer by Front key operation

1. Press and hold the SET key for 2 seconds at PV/SV monitor screen until Operation mode is displayed.

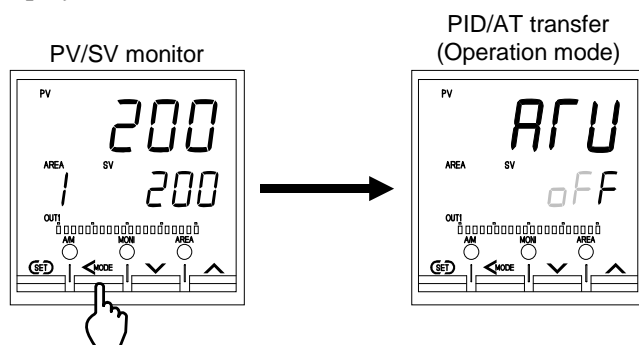

Press and hold for 2 seconds

- Press the Shift key several times until RUN/STOP transfer screen is displayed.

PID/AT transfer (Operation mode)

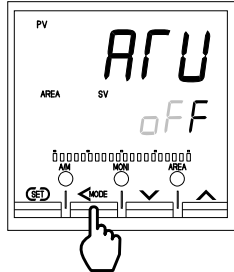

RUN/STOP transfer

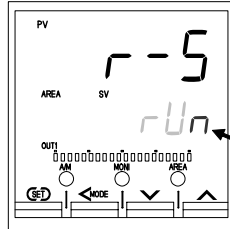

RUN mode

- Pressing the UP key changes to STOP mode from RUN mode.

RUN/STOP transfer

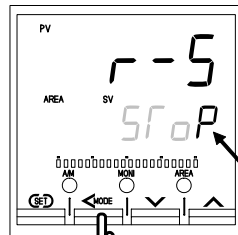
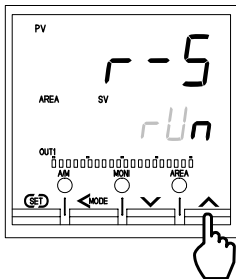

PV/SV monitor (STOP mode)

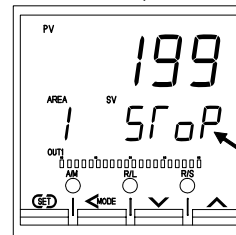

Symbol of showing STOP

Press and hold the Shift key for 2 seconds

- To change from STOP mode to RUN mode, press the DOWN key.

RUN/STOP transfer

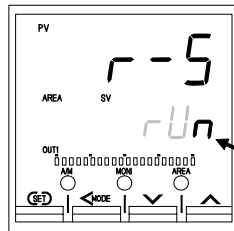
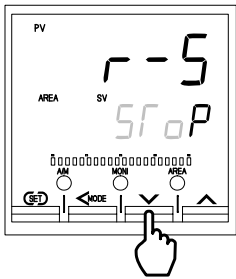

RUN mode

■ RUN/STOP transfer by Direct key (R/S) operation

RUN/STOP transfer by the Direct key is possible with the Direct key type of the Engineering mode. Set "2: Type 2" to the Direct key type.

Every time the RUN/STOP (R/S) transfer key is pressed, the RUN mode is changed to the STOP mode alternately.

For the Direct key type selection, refer to **7.5 Engineering Mode (P. 7-68)**.

- To change from RUN mode to STOP mode

PV/SV monitor (RUN mode)

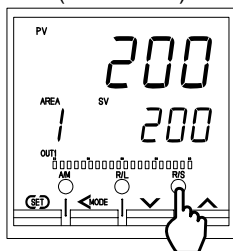

Press the <R/S key

RUN/STOP transfer (Operation mode)

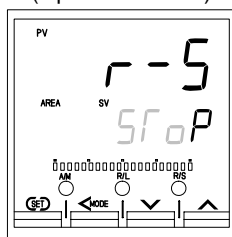

Display changes automatically

PV/SV monitor (STOP mode)

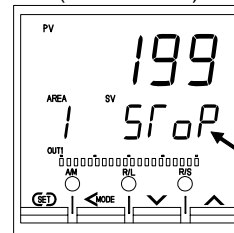

Symbol of showing STOP

- To change from STOP mode to RUN mode

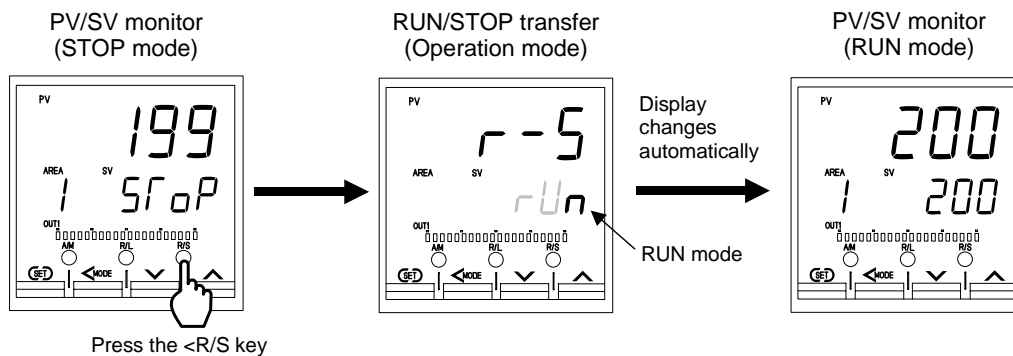

- RUN/STOP transfer by Digital input (DI)

RUN/STOP transfer by the Digital input (DI) is possible with the Digital input (DI) of the Engineering mode.

For the Digital input (DI) assignment, refer to **7.5 Engineering Mode (P. 7-78)**.

- Terminal Configuration

Digital input (DI5 to DI7)

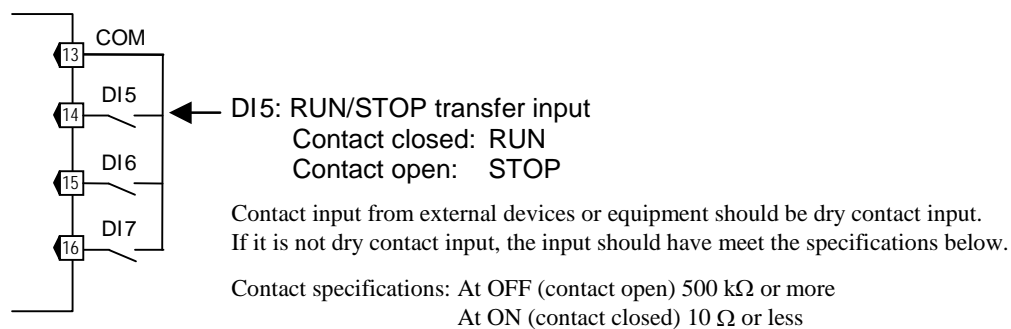

- Transfer timing of RUN/STOP

When the contact is closed, RUN. When the contact is open, STOP.

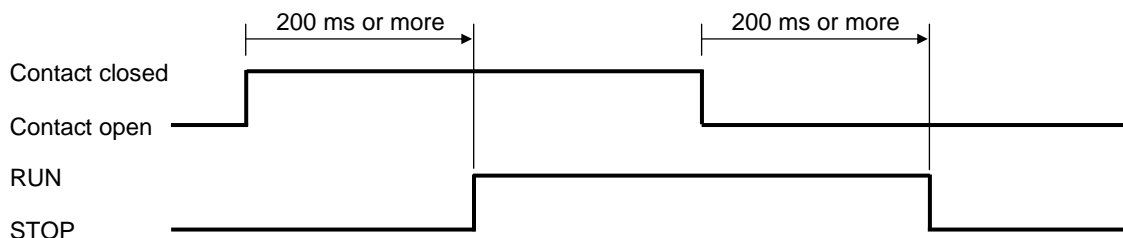

After the contact is transferred, it takes “200 ms + 1 sampling cycle*” until the action of this instrument is actually selected.

* Sampling cycle: The value selected by the sampling cycle of the Engineering mode. (Factory set value: 100 ms)

● **RUN/STOP transfer state**

The table below shows the actual RUN/STOP modes and displays under different combinations of settings by Key operation, Communication, and Digital input (DI).

RUN/STOP mode from key operation or communication	RUN/STOP mode by Digital input (DI)	Actual RUN/STOP mode state	State of STOP character display
RUN	Contact closed (RUN)	RUN	STOP is not displayed
	Contact open (STOP)	STOP	<i>dSfP</i>
STOP	Contact closed (RUN)		<i>uSfP</i>
	Contact open (STOP)		<i>Sf oP</i>

● **STOP character display**

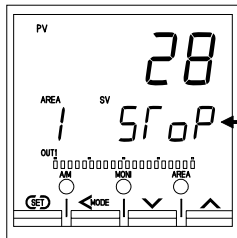

Display when STOP mode is changed by Key operation
 [When there is no RUN/STOP transfer by the digital input (DI)]

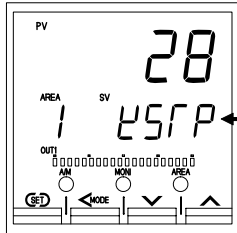

Display when STOP mode is changed by Key operation
 [When there is RUN/STOP transfer by the digital input (DI)]

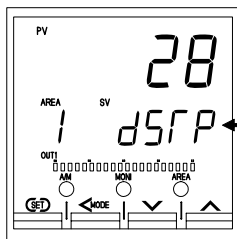

Display when STOP mode is selected by the Digital input (DI)



The display unit to display the STOP character can be changed from the SV display section to the PV display section by referring to “STOP display” in the Engineering mode.

6.5 Autotuning (AT)

The Autotuning (AT) function automatically measures, computes and sets the optimum PID values. The Autotuning (AT) can be used for PID control (Direct/Reverse action), Heat/Cool PID control, and Position proportioning PID control (Direct/Reverse action).

■ Caution for using the Autotuning (AT)

- When a temperature change (UP and/or Down) is 1 °C or less per minute during Autotuning (AT), Autotuning (AT) may not be finished normally. In that case, adjust the PID values manually. Manual setting of PID values may also be necessary if the set value is around the ambient temperature or is close to the maximum temperature achieved by the load.
- If the output change rate limiter is set, the optimum PID values may not be computed by Autotuning (AT).

■ Requirements for Autotuning (AT) start

Start the Autotuning (AT) when all following conditions are satisfied:

To start Autotuning (AT), go to PID/AT transfer in Operation mode.

Operation mode state	RUN/STOP transfer	RUN
	PID/AT transfer	PID control
	Auto/Manual transfer	Auto mode
	Remote/Local transfer	Local mode
Parameter setting	Output limiter high ≥ 0.1 %, Output limiter low ≤ 99.9 %	
Input value state	The Measured value (PV) is not underscale or over-scale.	
	Input error determination point (high) \geq Measured value (PV) \geq Input error determination point (low)	

■ Requirements for Autotuning (AT) cancellation

If the Autotuning (AT) is canceled according to any of the following conditions, the controller immediately changes to PID control. The PID values will be the same as before Autotuning (AT) was activated.

When the Operation mode is transferred	When the RUN/STOP mode is changed to the STOP mode.
	When the PID/AT transfer is changed to the PID control.
	When the Auto/Manual mode is changed to the Manual mode.
	When the Remote/Local mode is changed to the Remote mode.
When the parameter is changed	When the temperature Set value (SV) is changed.
	When the PV bias, the PV digital filter, or the PV ratio is changed.
	When the control area is changed.
When the input value becomes abnormal	When the Measured value (PV) goes to underscale or over-scale.
	When the Measured value (PV) goes to input error range. (Measured value (PV) \geq Input error determination point (high) or Input error determination point (low) \geq Measured value (PV))
When the AT exceeded the execution time	When the AT does not end in two hours after AT started.
Power failure	When the power failure of more than 20 ms occurs.
Instrument error	When the instrument is in the FAIL state.

■ Autotuning (AT) start/stop operation

The Autotuning function can start from any state after power on, during a rise in temperature or in stable control.

1. Press and hold the Shift key for 2 seconds at PV/SV monitor screen until Operation mode is displayed. PID/AT transfer screen is displayed first.

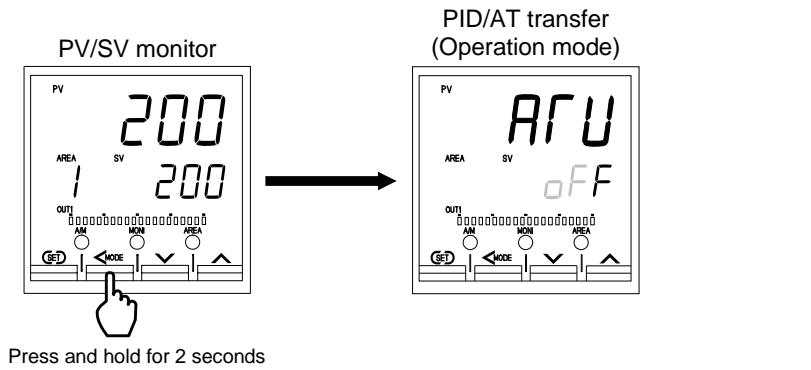

2. If set to “on” by pressing the UP key, the Autotuning (AT) function starts. At this time, the AT lamp flashes.

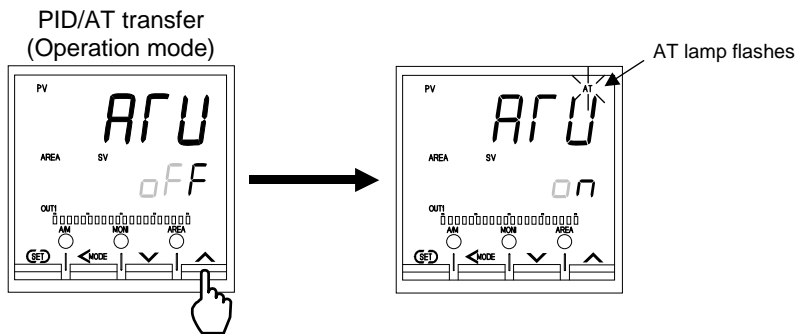

3. When the Autotuning (AT) is finished, the control will automatically returns to PID control. At this time, the AT lamp turns off.

- When canceling the Autotuning (AT) function, press the DOWN key to be set to “oFF.”

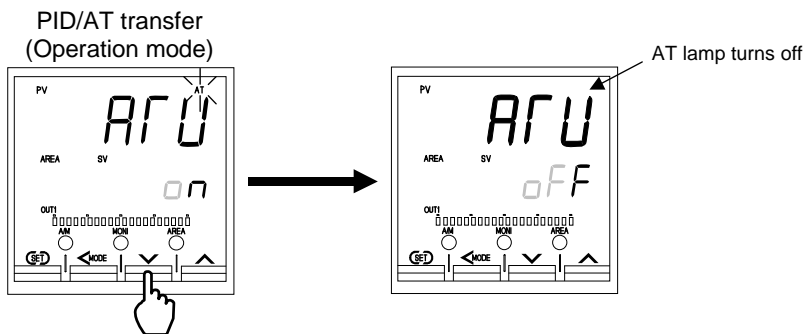

● Parameters for Autotuning (AT)

Parameters for Autotuning (AT) are provided to compute the PID values suitable for various controlled systems and control actions. Set them, as required. Set the parameters for Autotuning (AT) in the Engineering mode.

Example 1: When you want to find each constant suited for P control, PI control, or PD control by Autotuning.

For P control:

Set “0” to Integral time limiter (high) [heat-side] and Derivative time limiter (high) [heat-side].

For PI control:

Set “0” to Derivative time limiter (high) [heat-side].

For PD control:

Set “0” to Integral time limiter (high) [heat-side].

When Autotuning (AT) is executed by making the settings above, the control constants suited for P, PI, or PD control are found.



Also corresponds to Heat/Cool PID control cool-side and Position proportioning PID control.

Example 2: When you want to limit on/off output only at Autotuning (AT)

Autotuning (AT) that limits the ON/OFF output values only at Autotuning (AT) can be executed by setting the output value with AT turned on and the output value with AT turned off.



Only when the Feedback resistance (FBR) input is connected in the Position proportioning PID control, the “Output value with AT turned on” and “Output value with AT turned off” setting becomes valid.



As the other parameters for Autotuning (AT) function, there are AT bias, AT cycle, or AT differential gap time. For the each parameter, refer to **7.5 Engineering Mode (P. 7-146 to P. 7-148)**.

6.6 Startup Tuning (ST)

Startup tuning (ST) is a function which automatically computes and sets the PID values from the response characteristics of the controlled system at power ON, transfer from STOP to RUN, and Set value (SV) change.

- As simple autotuning, the PID values can be found in a short time without disturbing controllability for controlled systems with slow response at power ON.
- For controlled systems which require different PID values for each temperature setting, the PID values can be found for each Set value (SV) change.

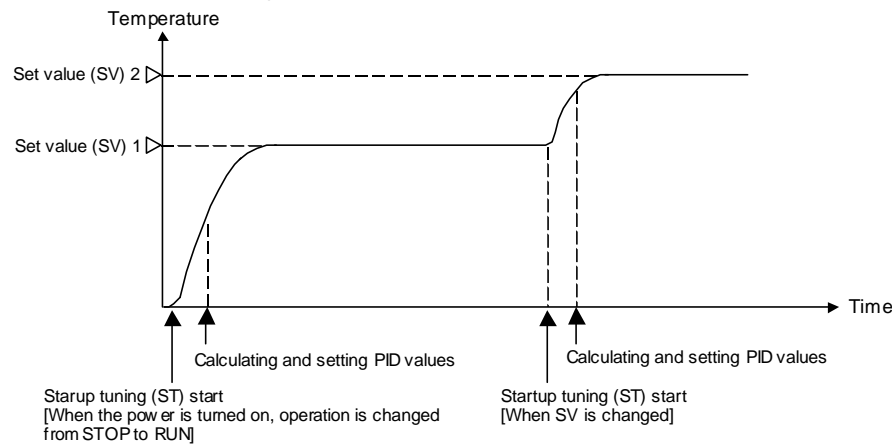

- The setting items related to Startup tuning (ST) are shown below. Set them according to the application used.

Setting item	Details		Setting mode
Start condition	0 (Factory set value)	When the power is turned on, operation is changed from STOP to RUN, or the Set value (SV) is changed.	Engineering mode
	1	When the power is turned on or operation is changed from STOP to RUN.	
	2	When the Set value (SV) is changed.	
Execution method	on1	Execute once	Operation mode
	on2	Execute always	
	oFF (Factory set value)	ST unused	



Startup tuning (ST) function does not correspond to the Heat/Cool PID control (only in the temperature fall direction) and the Position proportioning PID control.



If the Startup tuning (ST) function is executed just when the power is turned on or selection is made from STOP to RUN as one of the ST startup conditions, control starts at Hot start 2 even if set to Hot start 1 (factory set value).

Refer to ■ **Hot/Cold start selection (P. 6-39)**.

■ Caution for using the Startup tuning (ST)

- For Startup tuning (ST) at power ON or transfer from STOP to RUN, always set the heater power to ON simultaneously with the start of tuning or before the start of tuning.
- Start Startup tuning (ST) in the state in which the temperature differential of the Measured value (PV) and Set value (SV) at the start of Startup tuning (ST) is twice the proportional band, or greater.
- If in Heat/Cool PID control, start activating the Startup tuning (ST) function under the condition of “Set value (SV) > Measured value (PV).” Only the PID values on the heat-side are automatically computed but no PID values on the cool-side are changed. Execute the Autotuning (AT) function to the PID valued on the cool-side.
- When the manipulated output may be limited by the Output limiter setting, the optimum PID values may not be computed by Startup tuning (ST).
- When setting the Output change rate limiter, the optimum PID values may not be computed by Startup tuning (ST).
- When setting the Setting change rate limiter, the optimum PID values are not obtained even when Startup tuning (ST) is executed at Set value (SV) change.

■ Requirements for Startup tuning (ST) start

Start the Startup tuning (ST) when all following conditions are satisfied:

Operation mode state	RUN/STOP transfer	RUN
	PID/AT transfer	PID control
	Auto/Manual transfer	Auto mode
	Remote/Local transfer	Local mode
Parameter setting	Startup tuning (ST) is set to ON. (Execute once, Execute always)	
	Output limiter high ≥ 0.1 %, Output limiter low ≤ 99.9 %	
Input value state	The Measured value (PV) is not underscale or over-scale.	
	Input error determination point (high) \geq Measured value (PV) \geq Input error determination point (low)	
	At Startup tuning (ST) at Set value (SV) change, the Measured value (PV) shall be stabilized.	
	Set value (SV) $>$ Measured value (PV) (Heat/Cool PID control)	
Output value state	At startup, output is changed and saturated at the Output limiter high or the Output limiter low.	

■ Requirements for Startup tuning (ST) cancellation

If the Startup tuning (ST) is canceled according to any of the following conditions, the controller immediately changes to PID control. The PID values will be the same as before ST was activated.

When the parameter is changed	When Startup tuning (ST) is set to OFF
	When the PV bias, the PV digital filter, or the PV ratio is changed.
When the Operation mode is transferred	When the RUN/STOP mode is changed to the STOP mode.
	When the Autotuning (AT) is activated.
	When the Auto/Manual mode is changed to the Manual mode.
When the input value becomes abnormal	When the Remote/Local mode is changed to the Remote mode.
	When the Measured value (PV) goes to underscale or over-scale.
When the ST exceeded the execution time	When the Measured value (PV) goes to input error range. (Measured value (PV) \geq Input error determination point (high) or Input error determination point (low) \geq Measured value (PV))
	When the ST does not end in hundred minutes after ST started.
Power failure	When the power failure of more than 20 ms occurs.
Instrument error	When the instrument is in the FAIL state.

■ Startup tuning (ST) setting

The setting procedure when executing Startup tuning (ST) only one time at power ON is shown below as a setting example.

Step 1: Set the start condition

First, set “When the power is turn on” to Startup tuning (ST) start condition by Engineering mode.

1. Change the operation mode from RUN mode to STOP mode.

 To change from RUN mode to STOP mode, refer to **6.4 RUN/STOP Transfer (P. 6-11)**.

2. Press the Shift key while pressing the SET key for 2 seconds at PV/SV monitor screen until Engineering mode is displayed. Function block 10 screen is displayed first.

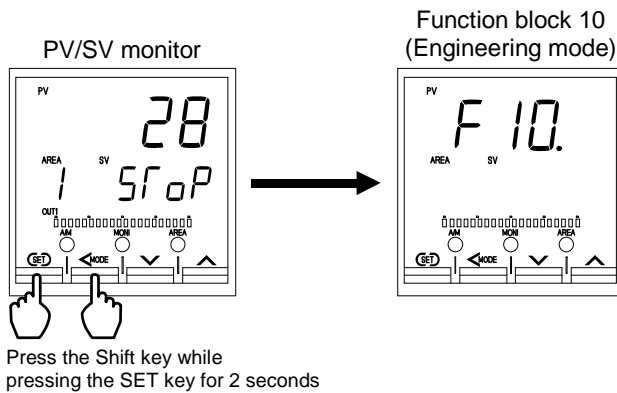

3. Press the DOWN key six times until Function block 54 screen is displayed.

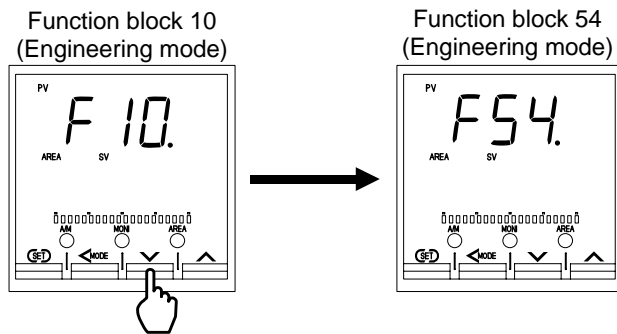

4. Press the SET key until ST start condition screen will be displayed.

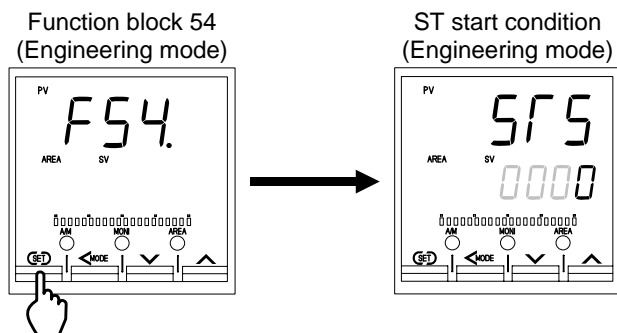

5. Press the UP key to change the number to 1.

ST start condition
(Engineering mode)

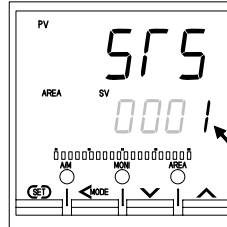
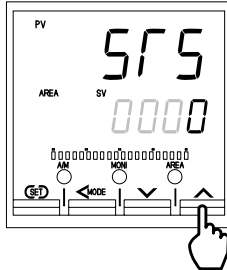

Setting range:

0: Activate the ST function when the power is turned on; when transferred from STOP to RUN; or when the Set value (SV) is changed

1: Activate the ST function when the power is turned on; or when transferred from STOP to RUN

2: Activate the ST function when Set value (SV) is changed

1: Activate the ST function when the power is turned on; or when transferred from STOP to RUN

6. Press the SET key to store the new value. The screen goes to the ST proportional band adjusting factor screen.

ST start condition
(Engineering mode)

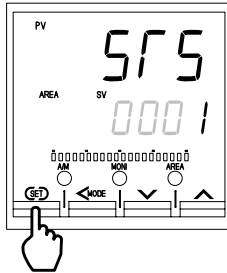

ST proportional band
adjusting factor
(Engineering mode)

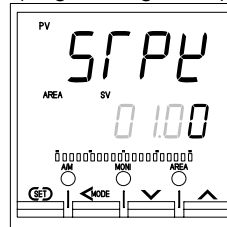

7. To return the PV/SV monitor, press the MONI key (for direct key type 1), or press the Shift key while pressing the SET key.

Step 2: Set the execution method

Set that the Startup tuning (ST) will be executed only once.

1. Change the operation mode from STOP mode to RUN mode by RUN/STOP transfer screen of Operation mode.

 To change from STOP mode to RUN mode, refer to **6.4 RUN/STOP Transfer (P. 6-11)**.

2. Press the Shift key twice at RUN/STOP transfer screen until Startup tuning (ST) screen is displayed.

RUN/STOP transfer
(Operation mode)

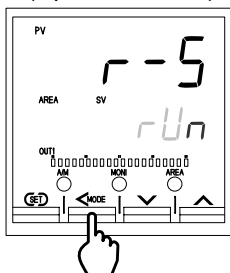

Startup tuning (ST)
(Operation mode)

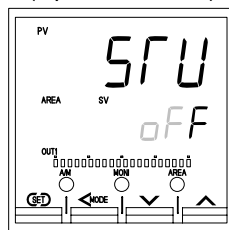

3. Press the UP key to set “on1 (Execute once).”

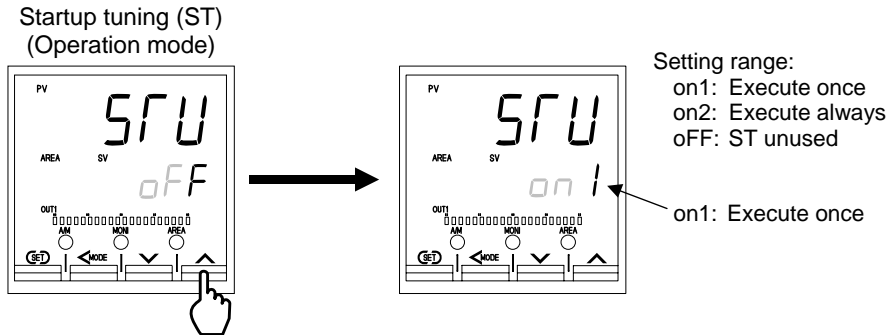

4. Thus, the Startup tuning (ST) setting has been finished.

Step 3: Start the Startup tuning (ST)

Turn off the power once and turn it on again. The Startup tuning (ST) will automatically start. When the calculation and setting of PID values is completed, setting of the Startup tuning (ST) screen will automatically change to “oFF.”

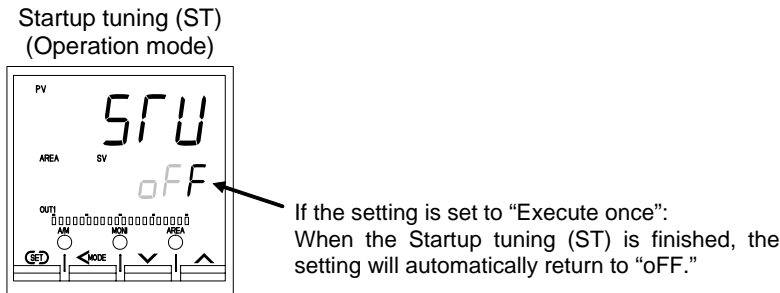

When Startup tuning (ST) was interrupted, the setting does not change to “oFF.”
Startup tuning (ST) starts when the restart conditions are satisfied.



As the parameters for Startup tuning (ST) function, there are ST proportional band adjusting factor, ST integral time adjusting factor, and ST derivative time adjusting factor in Engineering mode.

However, use the same setting as the factory set values (1.00 times).

Example: When set the proportional band adjusting factor

Proportional band (P) =

$$\text{Computed proportional band} \times \text{Proportional band adjusting factor (0.01 to 10.00 times)}$$

6.7 Auto/Manual Transfer

The Auto/Manual transfer can be made by Digital input (DI) or Communication (optional) other than the key operation.



When the digital input Auto/Manual transfer function is used, it is impossible to transfer Auto/Manual through key operation if the contact (DI5, DI6, or DI7) is not closed. (When DI5, DI6, or DI7 opens: Manual mode is maintained.)



For details of Auto/Manual transfer by Communication, refer to the separate **FB100/FB400/FB900 Communication Instruction Manual (IMR01W04-E□)**.



The Manipulated output value when changed to the Manual mode from the Auto mode differs depending on the MV transfer function (MVTs) setting. The MV transfer function (MVTs) enables the selection of whether a balanceless and bumpless transfer is made or a previous manipulated output value is used.



For the MV transfer function (MVTs), refer to **7.5 Engineering Mode (P. 7-128)**.

● Balanceless-bumpless function

This function is used to prevent overload caused by the Manipulated output value (MV) suddenly changing when Auto mode is transferred to Manual mode and vice versa.

Manipulated output value (MV)

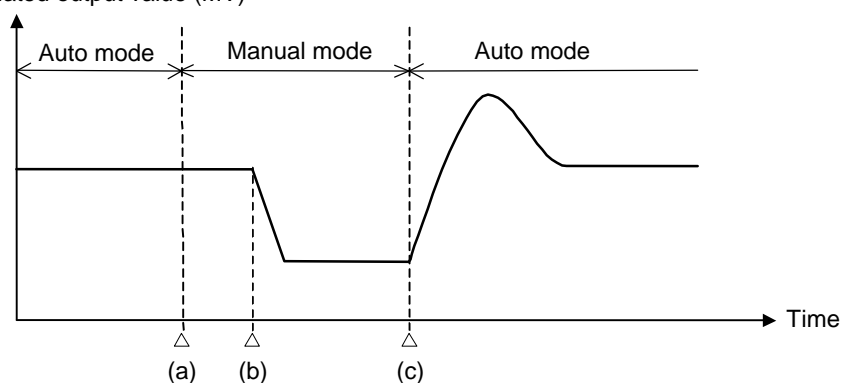

- (a) Transfer from Auto mode to Manual mode.

However, when the mode is transferred to Manual mode, the Manipulated output value used in Auto mode will be used as the manual output value in Manual mode.

- (b) The manipulated output value is changed (Manual mode function)

- (c) Transfer from Manual mode to Auto mode.

When the mode is transferred to Auto mode, the controller starts PID control based on the MV used in Manual mode.

■ Auto/Manual transfer by Front key operation

1. Press and hold the Shift key for 2 seconds at PV/SV monitor screen until Operation mode is displayed.

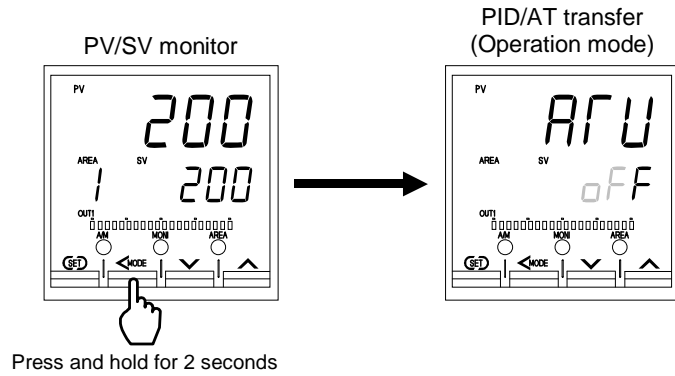

2. Press the Shift key several times until Auto/Manual transfer screen is displayed.

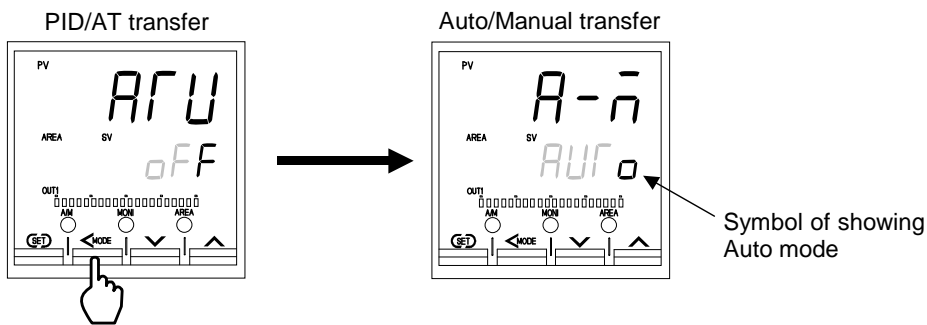

3. Press the UP key to change to the Manual mode from the Auto mode. The Manual (MAN) mode lamp lights.

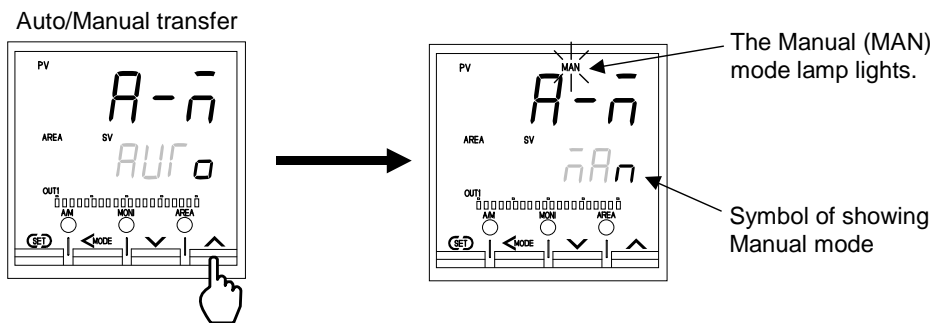

- To change from the Manual mode to the Auto mode, press the DOWN key.

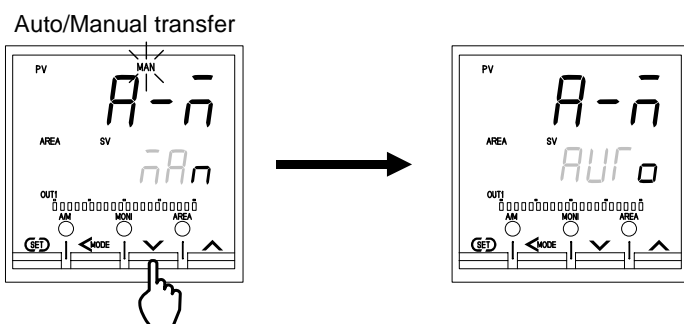

4. Press and hold the Shift key for 2 seconds to change to the PV/SV monitor from the Operation mode.

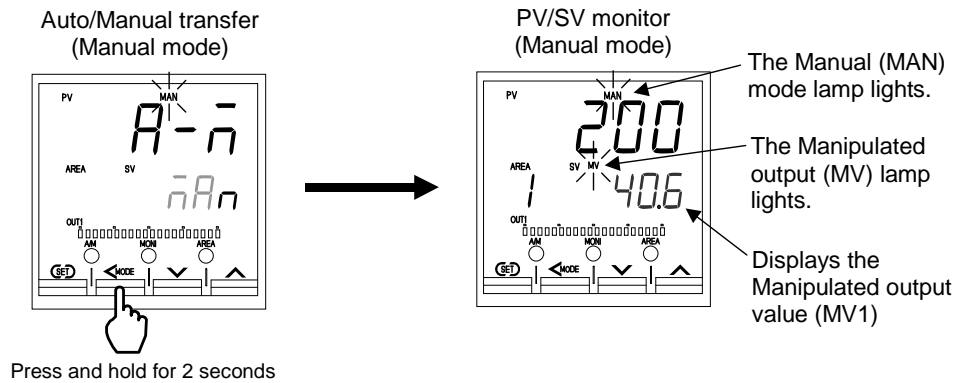

When in STOP mode, no Manual (MAN) mode lamp turns on.

■ Auto/Manual transfer by Direct key (A/M) operation

Every time the Auto/Manual (A/M) transfer key is pressed, the Auto mode is changed to the Manual mode alternately.

● To change from Auto mode to Manual mode

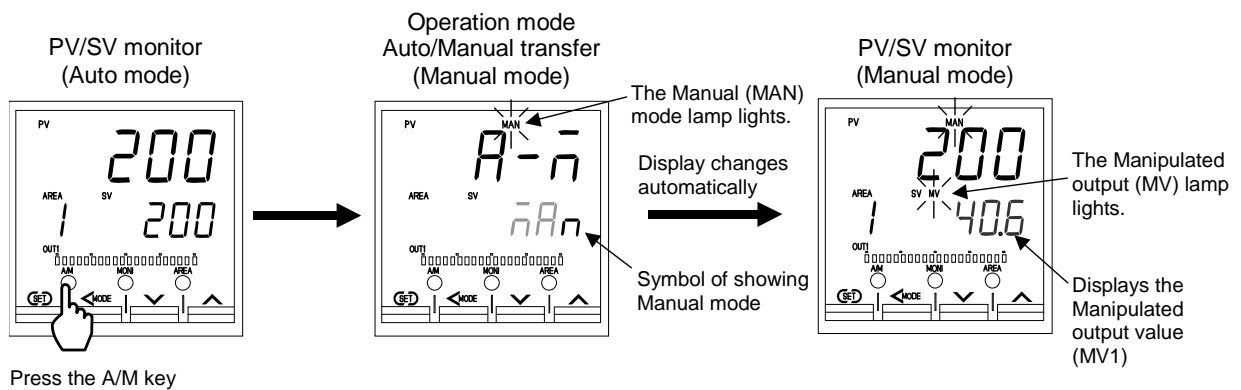

● To change from Manual mode to Auto mode

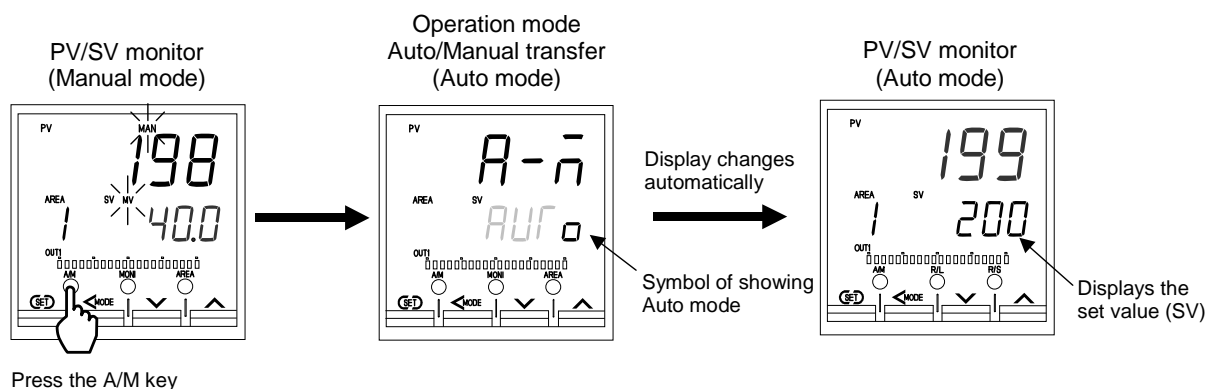

■ **Auto/Manual transfer by Digital input (DI)**

Auto/Manual transfer by the Digital input (DI) is possible with the Digital input (DI) assignment of the Engineering mode.

🗨 For the Digital input (DI) assignment, refer to **7.5 Engineering Mode (P. 7-78)**.

● **Terminal configuration**

Digital input (DI5 to DI7)

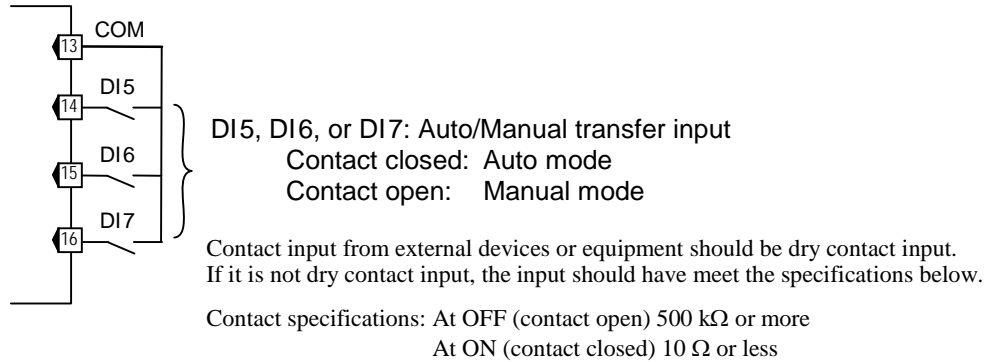

● **Transfer timing of Auto/Manual**

When the contact is closed, the mode changes to Auto. When the contact is open, the mode changes to Manual.

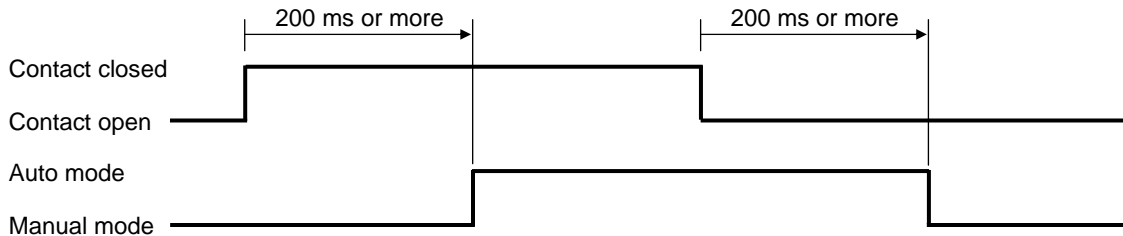

📖 **After the contact is transferred, it takes “200 ms + 1 sampling cycle* ” until the action of this instrument is actually selected.**

* Sampling cycle: The value selected by the sampling cycle of the Engineering mode. (Factory set value: 100 ms)

● **Auto/Manual transfer state**

The table below shows the actual Auto/Manual modes and displays under different combinations of settings by Key operation, Communication, and Digital input (DI).

Auto/Manual mode from Key operation or communication	Auto/Manual mode by Digital input (DI)	Actual Auto/Manual mode state	Display lamp state
Auto mode	Contact closed (Auto mode)	Auto mode	MAN mode lamp OFF
	Contact open (Manual mode)	Manual mode	MAN mode lamp ON
Manual mode	Contact closed (Auto mode)		
	Contact open (Manual mode)		

■ Procedure for setting the Manipulated output value (MV) in Manual mode

When the controller is in Manual mode, the Manipulated output value (MV) can be manually set.

Setting procedures:

1. Make sure the Manual (MAN) mode lamp and the Manipulated output (MV) are lit.

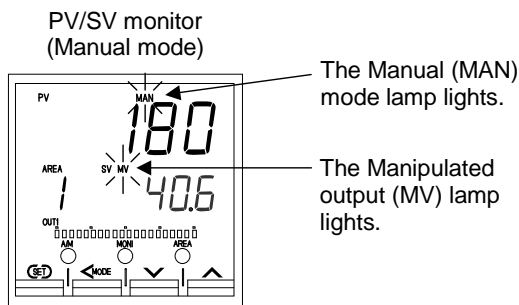

2. Set the Manipulated output value (MV) by UP or DOWN keys.

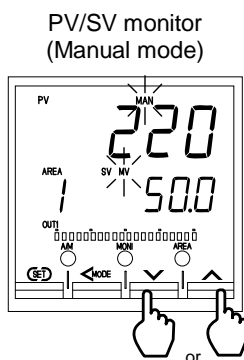

- UP key: Increase the Manipulated output value (MV).
- DOWN key: Decrease the Manipulated output value (MV).
- Keeping pressing the DOWN or UP key makes numeric value change faster.



For Position proportioning PID control:

- When there is a Feedback resistance (FBR) input, the valve position can be set by UP or DOWN key.

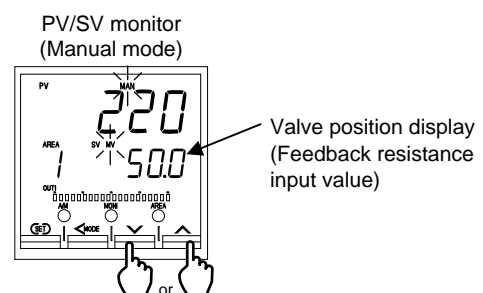

- When there is no Feedback resistance (FBR) input, the output becomes ON while the UP key [open-side output (OUT1)] or DOWN key [close-side output (OUT2)] is pressed and the output becomes OFF when your finger is removed from the key. MV is hidden.

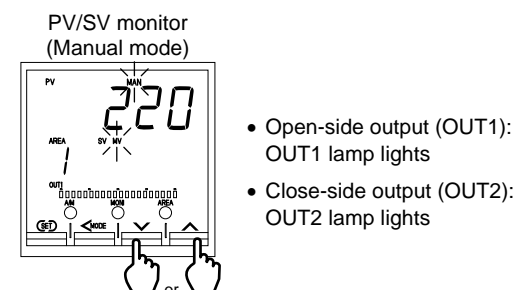

6.8 Remote/Local Transfer

The Remote/Local transfer can be made by Digital input (DI) or Communication (optional) other than the key operation.

-  **When the digital input Remote/Local transfer function is used, it is impossible to transfer Remote/Local through key operation if the contact (DI5 or DI6) is not closed. (When DI5 or DI6 opens: Local mode is maintained.)**
-  For details of the Remote/Local transfer by Communication, refer to the separate **FB100/FB400/FB900 Communication Instruction Manual (IMR01W04-E□)**.

■ Remote/Local transfer by Front key operation

1. Press and hold the Shift key for 2 seconds at PV/SV monitor screen until Operation mode is displayed.

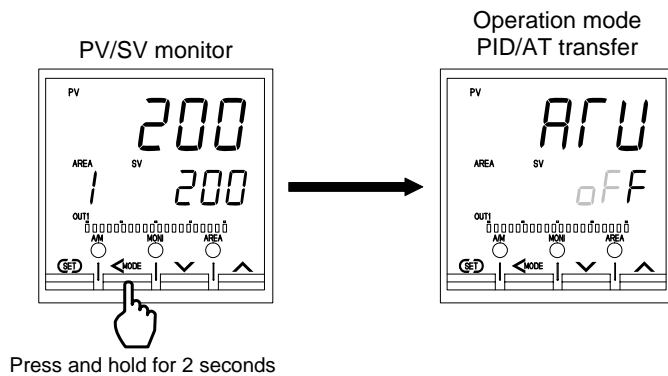

2. Press the Shift key several times until Remote/Local transfer screen is displayed.

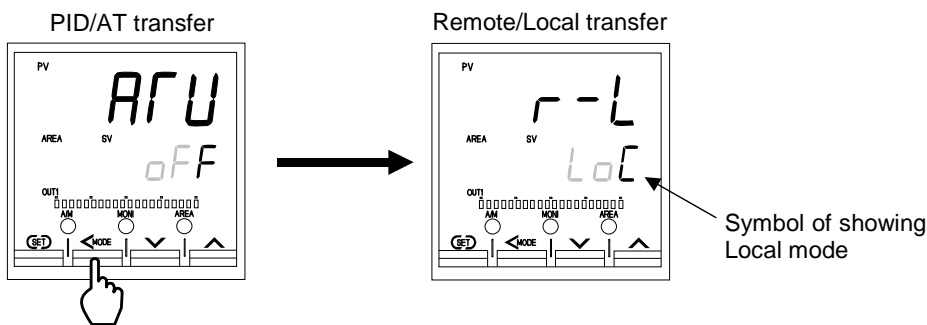

3. Press the UP key to change to the Remote mode from the Local mode. The Remote (REM) mode lamp lights.

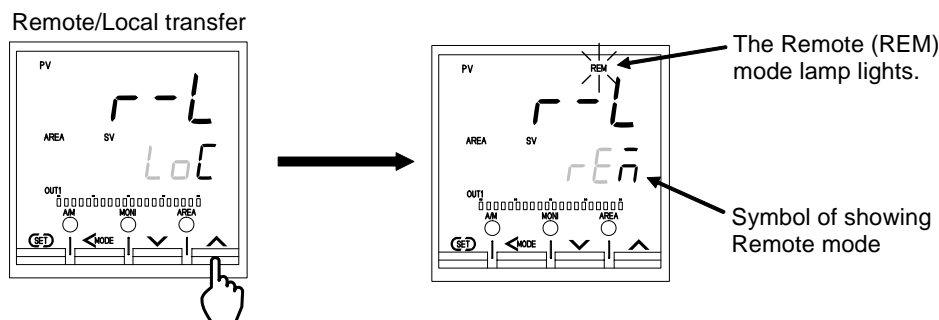

Continued on the next page.

Continued from the previous page.

- To change from the Remote mode to the Local mode, press the DOWN key.

Remote/Local transfer

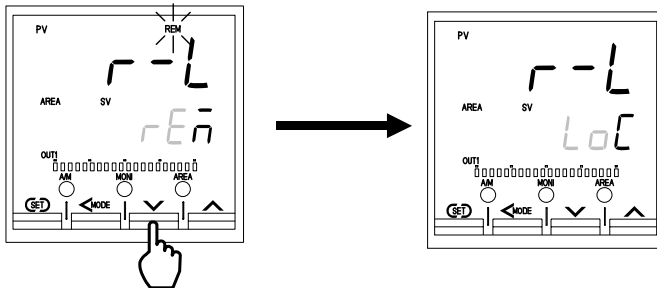

4. Press and hold the Shift key for 2 seconds to change to the PV/SV monitor from the Operation mode.

Remote/Local transfer

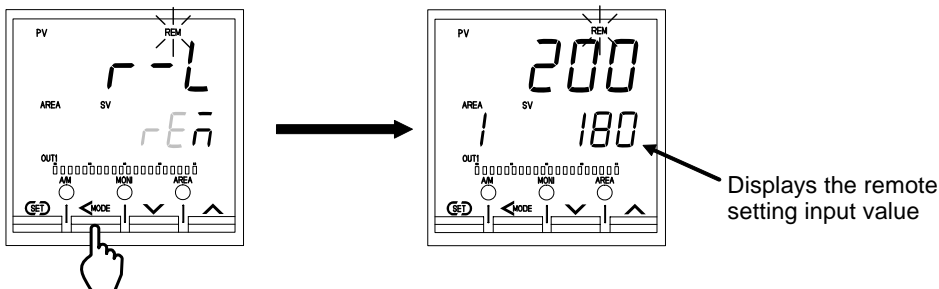

Press and hold for 2 seconds



When in STOP mode, no Remote (REM) mode lamp turns on.

■ Remote/Local transfer by Direct key (R/L) operation

Remote/Local transfer by the direct key is possible with the Direct key type of the Engineering mode. Set “2: Type 2” to the Direct key type. Every time the Remote/Local (R/L) transfer key is pressed, the Remote mode is changed to the Local mode alternately.



For the Direct key type selection, refer to **7.5 Engineering Mode (P. 7-68)**.

- To change from Local mode to Remote mode

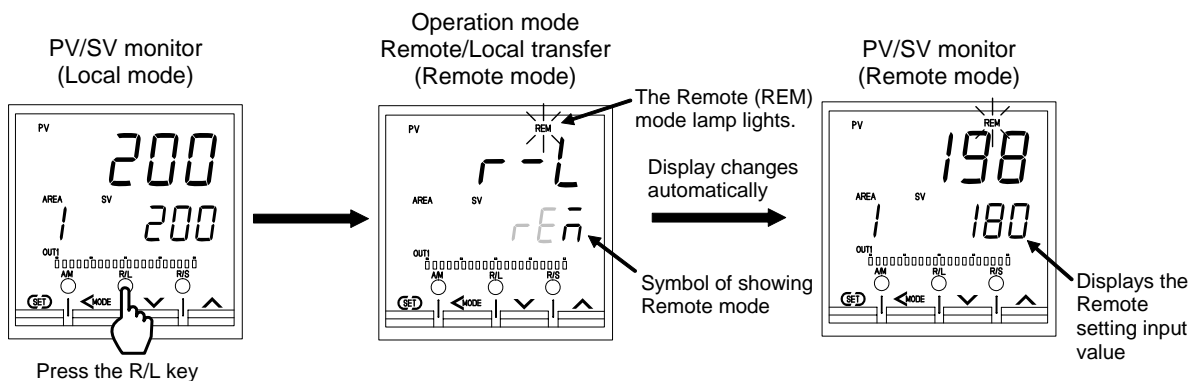

Press the R/L key

● To change from Remote mode to Local mode

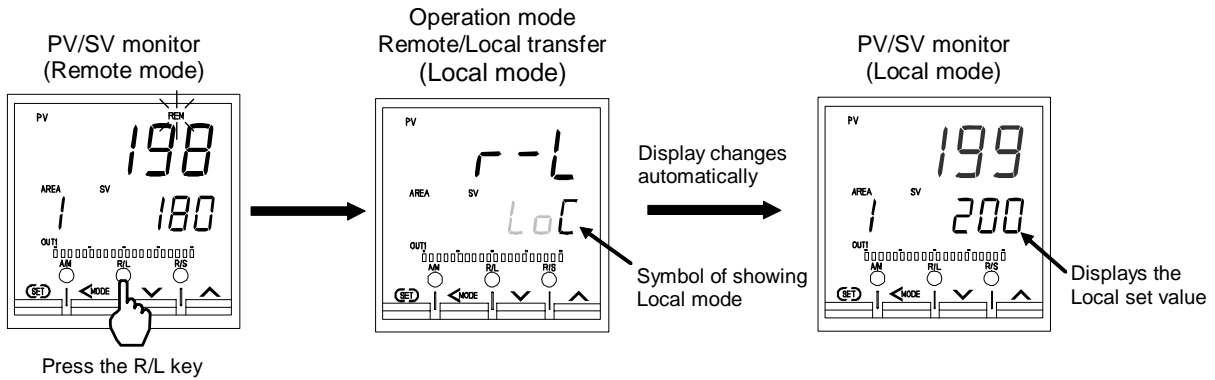

■ Remote/Local transfer by Digital input (DI)

Remote/Local transfer by the Digital input (DI) is possible with the Digital input (DI) assignment of the Engineering mode.

👉 For the Digital input (DI) assignment, refer to **7.5 Engineering Mode (P. 7-78)**.

● Terminal configuration

Digital input (DI5 to DI7)

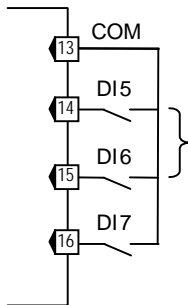

DI5 or DI6: Remote/Local transfer input
 Contact closed: Remote mode
 Contact open: Local mode

Contact input from external devices or equipment should be dry contact input. If it is not dry contact input, the input should have meet the specifications below.

Contact specifications: At OFF (contact open) 500 kΩ or more
 At ON (contact closed) 10 Ω or less

● Transfer timing of Remote/Local

When the contact is closed, the mode changes to Remote. When the contact is open, the mode changes to Local.

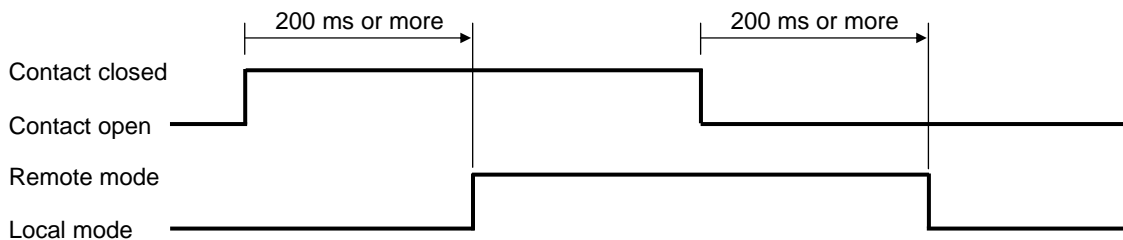

After the contact is transferred, it takes “200 ms + 1 sampling cycle*” until the action of this instrument is actually selected.

* Sampling cycle: The value selected by the sampling cycle of the Engineering mode. (Factory set value: 100 ms)

● **Remote/Local transfer state**

The table below shows the actual Remote/Local modes and displays under different combinations of settings by Key operation, Communication, and Digital input (DI).

Remote/Local mode from Key operation or communication	Remote/Local mode by Digital input (DI)	Actual Remote/Local mode state	Display lamp state
Remote mode	Contact closed (Remote mode)	Remote mode (Cascade control or Ratio setting)	REM mode lamp ON
	Contact open (Local mode)	Local mode	REM mode lamp OFF
Local mode	Contact closed (Remote mode)		
	Contact open (Local mode)		

6.9 Control Area Transfer



The control area transfer can be made by Digital input (optional), Communication (optional) or Area soak time other than the key operation.

-  For details of the Control area transfer by Communication, refer to the separate **FB100/FB400/FB900 Communication Instruction Manual (IMR01W04-E□)**.

● Memory area function

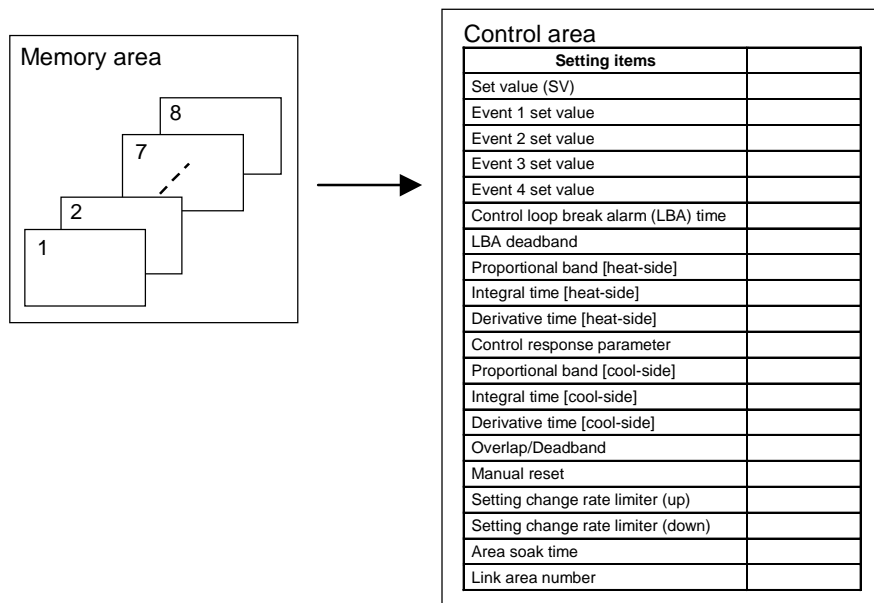
Multi memory area function can store up to 8 individual sets of SVs and parameters in Parameter setting mode. One of the Areas is used for control, and the currently selected area is Control area.



-  The memory area number (Control area) can be changed at either RUN or STOP.
-  The memory area number stored at last is taken as Control area.
-  Ramp/soak control is possible by using Area soak time, Link area number and Setting change rate limiter (up/down) in Parameter setting mode.
For details, refer to **6.13 Ramp/Soak Control (P. 6-50)**.

■ Control area transfer by Front key operation

 Only when the direct key type is Type 2, it is possible to transfer memory area by the front key operation. (Factory set value: Type 1)

 For the Direct key type selection, refer to 7.5 Engineering Mode (P. 7-68).

1. Press the SET key several times at PV/SV monitor screen until Memory area transfer screen is displayed.

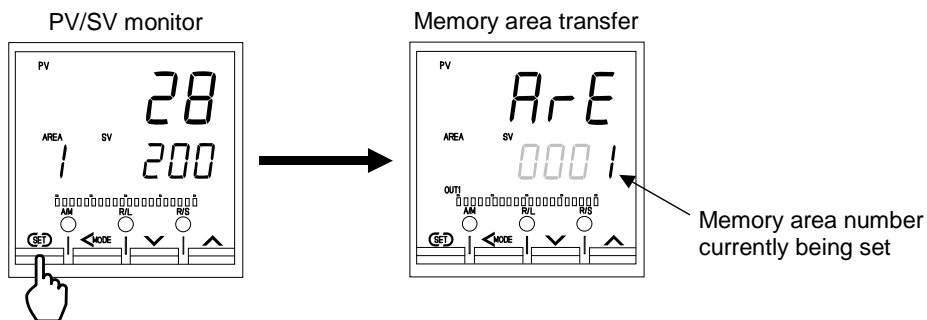

2. Select the memory area number which needs to be changed by pressing the UP or DOWN key.

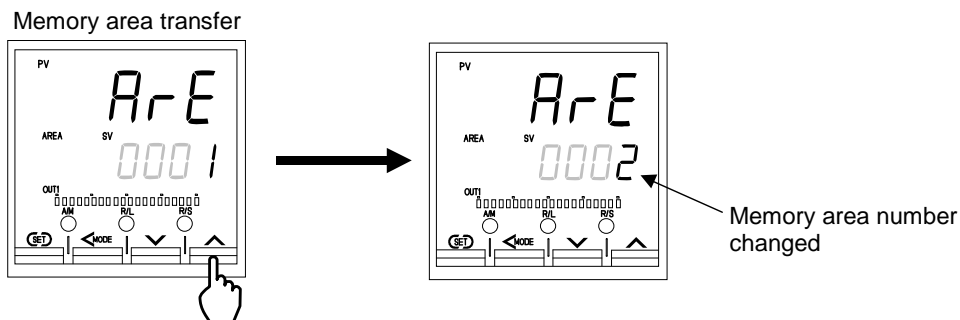

3. Press the SET key to store the new memory area number. The screen goes to the next parameter.

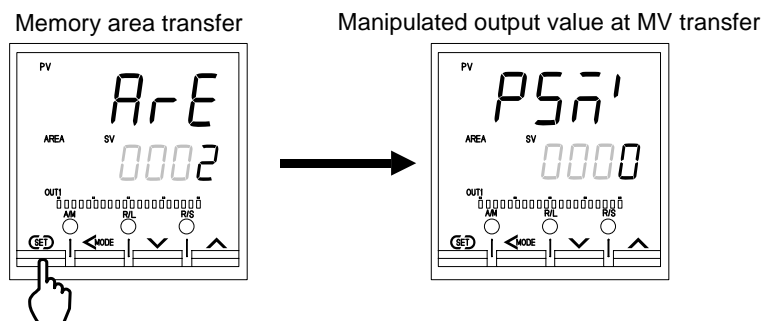

4. Press the SET key several times to return to the PV/SV monitor.

 After a new value is displayed on the display by using UP and DOWN keys, if no key operation is performed within 1 minute without pressing SET key, this instrument returns to the PV/SV monitor screen and the memory area number will not be changed.

■ **Control area transfer by Direct key (AREA) operation**

Memory area transfer by the Direct key is possible with the Direct key type of the Engineering mode. Set “1: Type 1” to the Direct key type. (Factory set value: Type 1)

 For the Direct key type selection, refer to **7.5 Engineering Mode (P. 7-68)**.

1. Press the AREA key at PV/SV monitor screen until Memory area transfer screen is displayed.

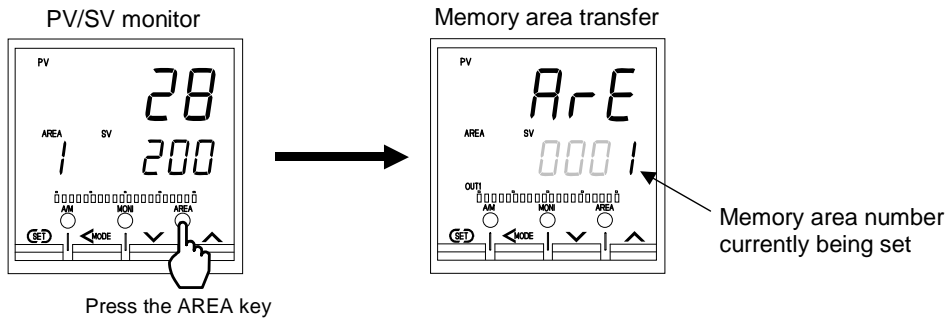

2. Select the memory area number which needs to be changed by pressing the UP or DOWN key.

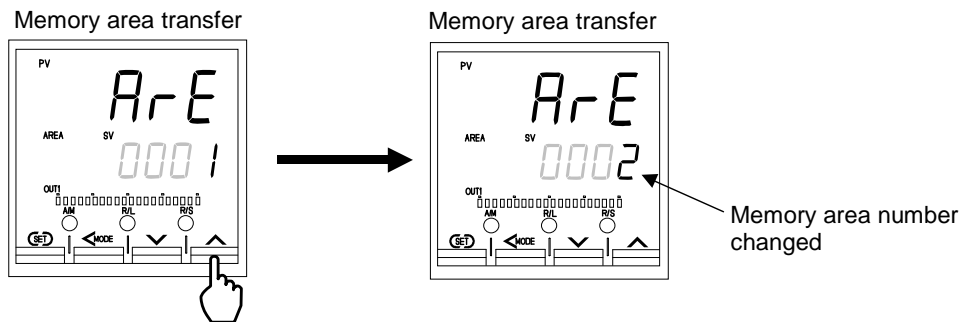

3. Press the SET key to store the new memory area number. The screen return to the PV/SV monitor screen.

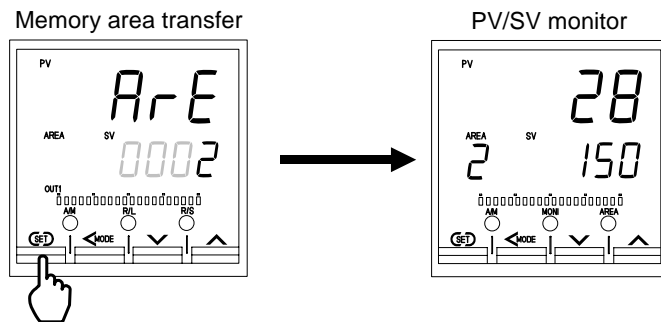

■ Control area transfer by Digital input (DI) [optional]

Memory area (Control area) transfer by the Digital input is possible with the Digital input (DI) assignment of the Engineering mode.

 For the Digital input (DI) assignment, refer to **7.5 Engineering Mode (P. 7-78)**.

● Terminal configuration

Digital input (DI1 to DI4)

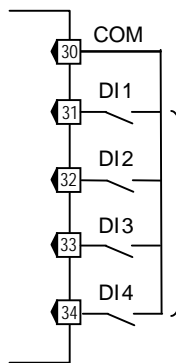

Only when ZK-1165 specification was specified, memory area transfer is possible without area set input. For memory area transfer by ZK-1165 specification, refer to **ZK-1165 Specification (IMR01W08-E□)**.

DI1 to DI3: Area transfer input
DI4: Area set input

Contact input from external devices or equipment should be dry contact input.
If it is not dry contact input, the input should have meet the specifications below.

Contact specifications: At OFF (contact open) 500 kΩ or more
At ON (contact closed) 10 Ω or less

The table below shows the Digital input (DI) status and selected memory numbers for Control area transfer.

Digital input	Memory area number							
	1	2	3	4	5	6	7	8
DI1	×	–	×	–	×	–	×	–
DI2	×	×	–	–	×	×	–	–
DI3	×	×	×	×	–	–	–	–

×: Contact open
–: Contact closed

● Transfer timing of memory area (Control area)

Select the memory area number according to the open or closed state of the contact (DI1 to DI3). Then, to store a new memory area number as the Control area, close the DI4 for Memory area set.

[Example] Change the memory area number to 6

First, close the contacts between DI1 and DI3 and the common terminal. Next, open the contact between DI2 and the common. Then, close the contact between DI4 (Area set) and the common from open status (rising edge), the memory area number in the controller will change to “6.”

1. Select the Memory area number

DI1: Contact closed
DI2: Contact open
DI3: Contact closed

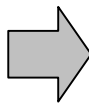

2. Change the Memory area

Contact closed ¹
DI4 (Memory area set)
Contact open — Rising edge → Memory area transfer

¹ To make contact activation valid, it is necessary to maintain the same contact state (contact closed) for more than 200 ms.



After the contact is closed, it takes “200 ms + 1 sampling cycle ²” until the action of this instrument is actually selected.

² Sampling cycle: The value selected by the sampling cycle of the Engineering mode. (Factory set value: 100 ms)

■ Control area transfer by Area soak time (Ramp/Soak Control)

When the memory area number is transferred by using the Area soak time, it is necessary to set the link area number (Parameter setting mode). For details, refer to **6.13 Ramp/Soak Control (P. 6-50)**.

6.10 Interlock Release

The Event interlock action holds the event state even if the measured value is out of the event zone after it enters the event zone once. The Interlock release can be made by Digital input (DI), or Communication (optional) other than the key operation.

 **To validate the Event interlock function, it is necessary to set Event interlock (EIL1 to 4) to “1: Used” in 7.5 Engineering Mode (P. 7-13).**

 For the Interlock release by Communication, refer to the separate **FB100/FB400/FB900 Communication Instruction Manual (IMR01W04-E□)**.

- The following example shows how the Event interlock is released.

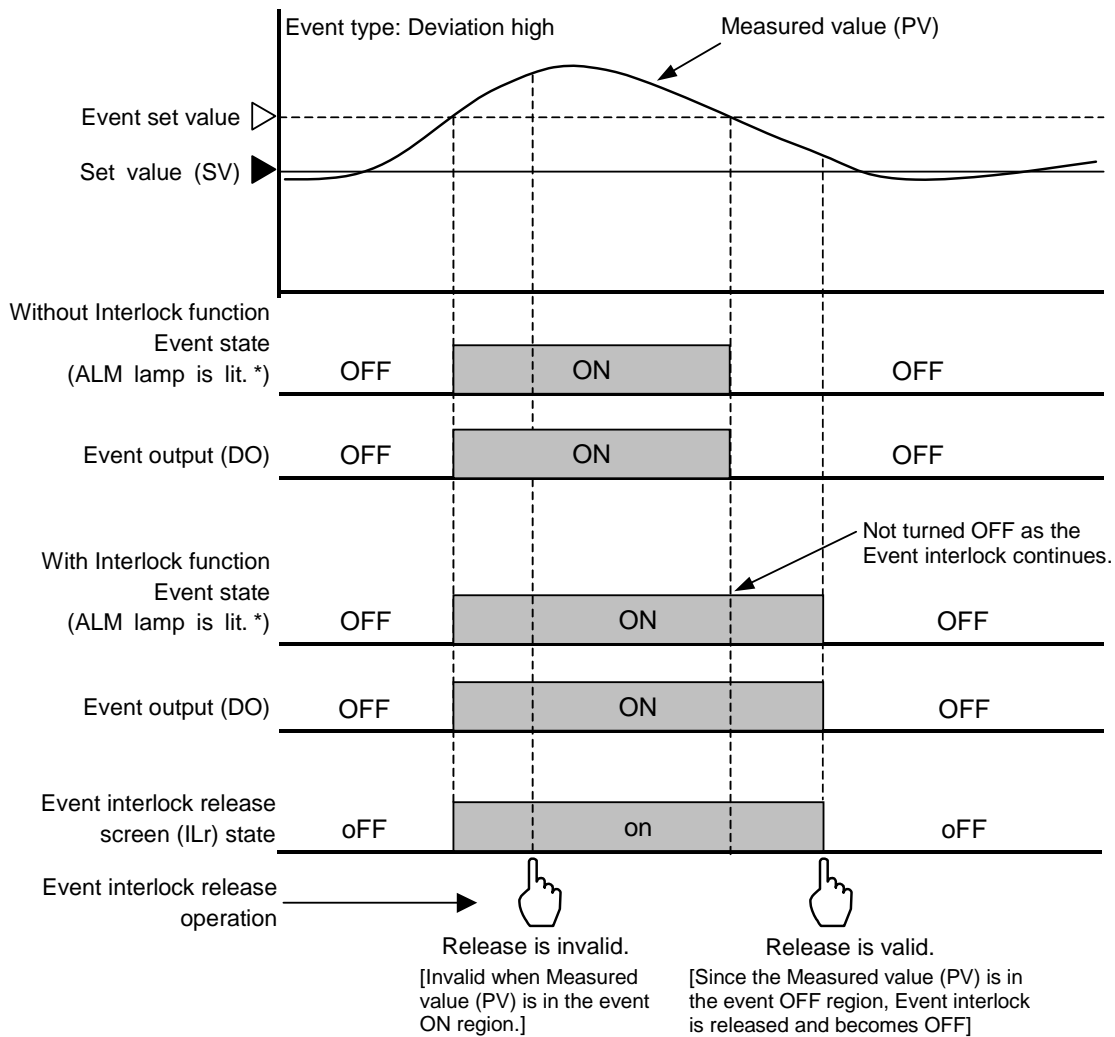

* Set an alarm lamp lighting conditions to EV1 to EV4 in the Engineering mode. The alarm (ALM) lamp is lit through the OR operation of EV1 to EV4 each of which is set to "1: ALM lamp is lit". (Factory set value: ALM lamp is lit)

■ Interlock release method by Front key operation

1. Press the SET key several times at PV/SV monitor screen until Interlock release screen is displayed.

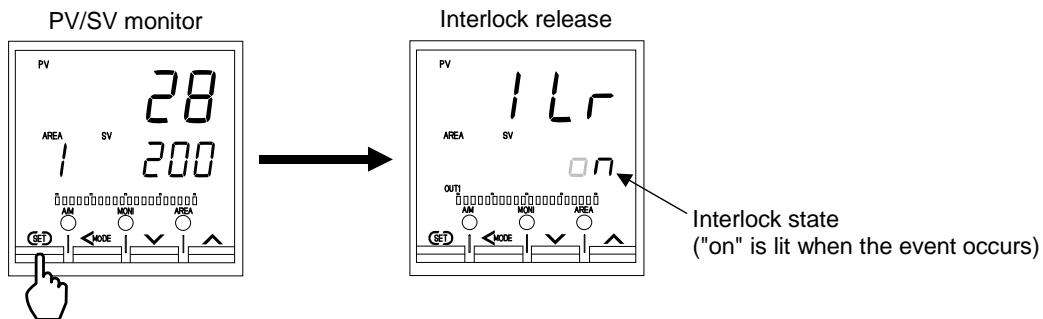

2. Press the DOWN key to release the interlock.

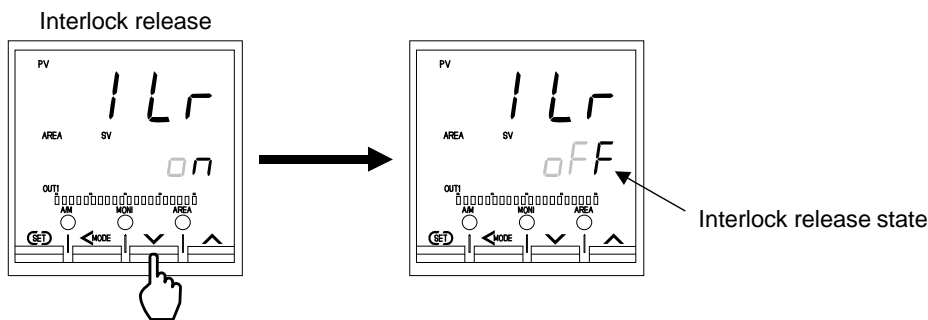

3. Press the SET key to return the PV/SV monitor.



After a new value is displayed on the display by using UP and DOWN keys, if no key operation is performed within 1 minute without pressing SET key, this instrument returns to the PV/SV monitor screen and the interlock will not be released.

■ Interlock release method by Digital input (DI)

Interlock release by the Digital input (DI) is possible with the Digital input (DI) assignment of the Engineering mode.

 For the Digital input (DI) assignment, refer to **7.5 Engineering Mode (P. 7-78)**.

● Terminal configuration

Digital input (DI5 to DI7)

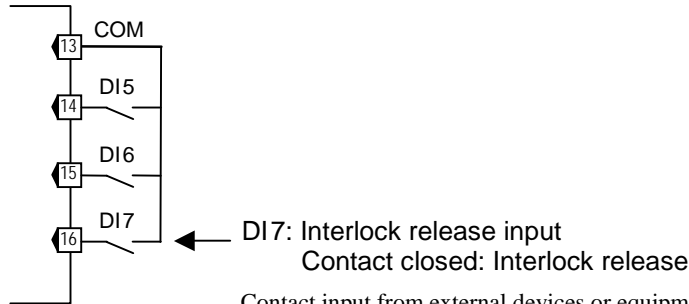

Contact input from external devices or equipment should be dry contact input. If it is not dry contact input, the input should have meet the specifications below.

Contact specifications: At OFF (contact open) 500 k Ω or more
At ON (contact closed) 10 Ω or less

● Transfer timing of Interlock release

The interlock release operation is taken when DI contact is closed from the open condition (rising edge).

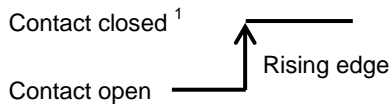

¹ To make contact activation valid, it is necessary to maintain the same contact state (contact closed) for more than 200 ms.



After the contact is closed, it takes “200 ms + 1 sampling cycle ²” until the action of this instrument is actually selected.

² Sampling cycle: The value selected by the sampling cycle of the Engineering mode. (Factory set value: 100 ms)

6.11 Start Action at Recovering Power Failure

■ Hot/Cold start selection

The operation of this instrument is not affected by a power failure of 20 ms or less. The control start mode at power recovery after more than 20 ms power failure can be selected as follows.

Action when power failure recovers	Operation mode when power failure recovers	Output value when power failure recovers	
Hot start 1	Same as that before power failure	Near the output value before power failure occurs	
Hot start 2	Same as that before power failure	Auto mode	Value as a result of control computation ²
		Manual mode	Output limiter low ³
Cold start	Manual mode	Output limiter low ³	
STOP start	Started in the control stop (STOP) state regardless of the RUN mode before power failure. ¹	Manipulated output value at STOP mode ³	

Factory set value: Hot start 1

¹ If changed to RUN from STOP by RUN/STOP selection after start, set to the operation mode before power failure occurs.

² The result of control computation varies with the control response parameter.

³ If there is no Feedback resistance (FBR) input in Position proportioning PID control, the following results.

- Hot start 2 (Manual mode): No output (no control motor is driven)
- Cold start: No output (no control motor is driven)
- STOP start: In accordance with the setting of valve action at STOP.



If the Startup tuning (ST) function is executed or an automatic temperature rise is made just when the power is turned on or selection is made from STOP to RUN as one of the startup conditions, control starts at Hot start 2 even if set to Hot start 1 (factory set value).



Control start mode when the controller recovers from power failure can be selected in Engineering mode. For details, refer to **7.5 Engineering Mode (P. 7-123)**.

■ Start determination point

In addition to Hot/Cold start selection, set the determination point of Hot start 1.

The Start determination point becomes the deviation setting from the Set value (SV).

- The start state is determined according to the Measured value (PV) level [deviation from set value] at power recovery.
- When a Measured value (PV) is between the determination points on the + (plus) and – (minus) sides, always started from Hot start 1 when recovered.
- When a Measured value (PV) is out of the determination points or the Start determination point is set at “0,” operation starts from any start state selected by Hot/Cold start.

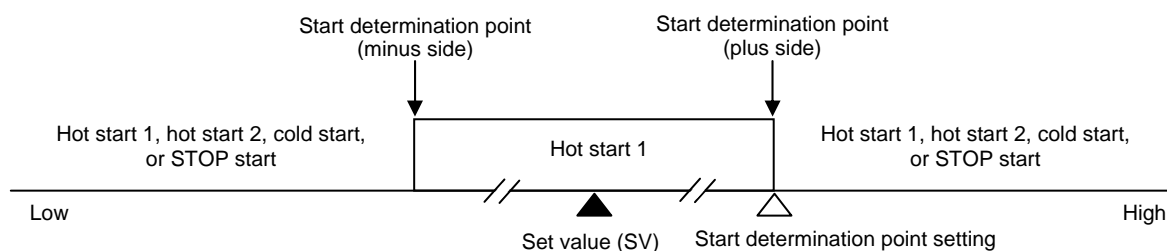

Start determination point setting is conducted in Engineering mode. For details, refer to **7.5 Engineering Mode (P. 7-124)**.

6.12 Position Proportioning PID Control

Position proportioning PID control converts the control output value of the controller into the corresponding signal to control a motor driven valve (control motor) and then performs temperature control of a controlled object by regulating fluid flow.

In Position proportioning PID control of this controller, it is possible to select the presence or absence of Feedback resistance (FBR) input which monitors the degree of valve position (Specify when ordering). In addition, the direct action or reverse action can be selected.

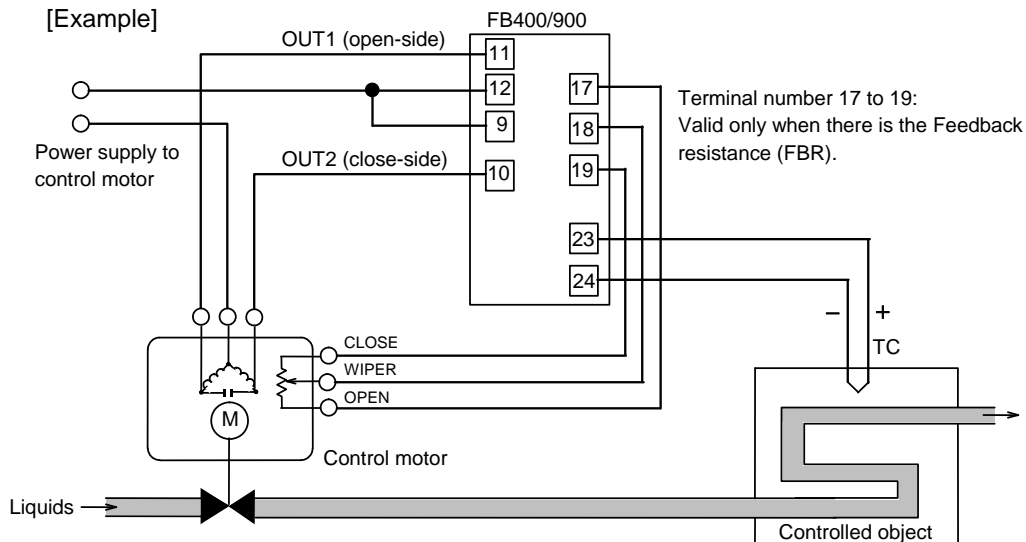

The details of setting differ depending on the presence or absence of Feedback resistance (FBR) input.

When there is a Feedback resistance (FBR) input:

- High/Low limit of valve position (limit value of FBR input) can be set.
[Output limiter high, Output limiter low]
- Valve position can be manually set.
[Manipulated output value (MV) setting in Manual mode]
- Feedback adjustment is necessary. [Feedback adjustment]
- Action at Feedback resistance (FBR) input error can be selected.
[Action at Feedback resistance (FBR) input error]
- Output value (FBR input) with the output turned on or off when the Autotuning (AT) function is executed can be restricted. [Output value with AT turned on, Output value with AT turned off]
- The close-side (or open-side) output remains ON when the valve position is fully closed (or opened).
[Action at saturated output]

When there is no Feedback resistance (FBR) input:

- Control motor operation can be restricted by the integrated output limiter. [Integrated output limiter]
- The UP or DOWN key is used to output opening or closing signal in Manual mode.
UP key (open-side): While the UP key is being pressed, open-side output (OUT1) is output continuously. Releasing the UP key turns off the open-side output to hold the opened state at that time.
DOWN key (close-side): While the DOWN key is being pressed, close-side output (OUT2) is output continuously. Releasing the DOWN key turns off the close-side output to hold the opened state at that time.

 For Manual operation in Position proportioning PID control, refer to **6.7 Auto/Manual Transfer (P. 6-27)**.

Parameter valid/invalid depending on the presence or absence of Feedback resistance (FBR) input (× : Valid, – : Invalid)

Parameter (Engineering mode)	With Feedback resistance (FBR) input	Without Feedback resistance (FBR) input
Manipulated output value (MV) at STOP mode ($r\bar{n}H\ l$) [Function block 51]	×	–
Output limiter high ($\sigma L H$) Output limiter low ($\sigma L L$) [Function block 51]	×	–
Output value with AT turned on ($AF\ \sigma n$) Output value with AT turned off ($AF\ \sigma F$) [Function block 52]	×	–
Open/Close output neutral zone (Ydb) * [Function block 53]	×	×
Open/Close output differential gap (YHS)* [Function block 53]	×	×
Action at feedback resistance (FBR) input error (Ybr) [Function block 53]	×	–
Feedback adjustment ($P\ \sigma S$) [Function block 53]	×	–
Control motor time ($\bar{n}\ \sigma f$) * [Function block 53]	×	×
Integrated output limiter ($\sigma L R$) [Function block 53]	–	×
Valve action at STOP (HAL) * [Function block 53]	×	×
Action at saturated output ($YAS\ \sigma$) [Function block 53]	×	–

* These parameters are necessary to set regardless of the presence or absence of Feedback resistance (FBR) input.



Position proportioning PID control can be performed if two output points are selected when ordering.



Startup tuning (ST) cannot be executed by Position proportioning PID control. In addition, the Output change rate limiter also becomes invalid.

■ **Setting flowchart**

This section describes the Position proportioning PID control dedicated setting items and the setting items which are effective when there is or is not a Feedback resistance (FBR) input. The following setting items are all set in the Engineering mode.

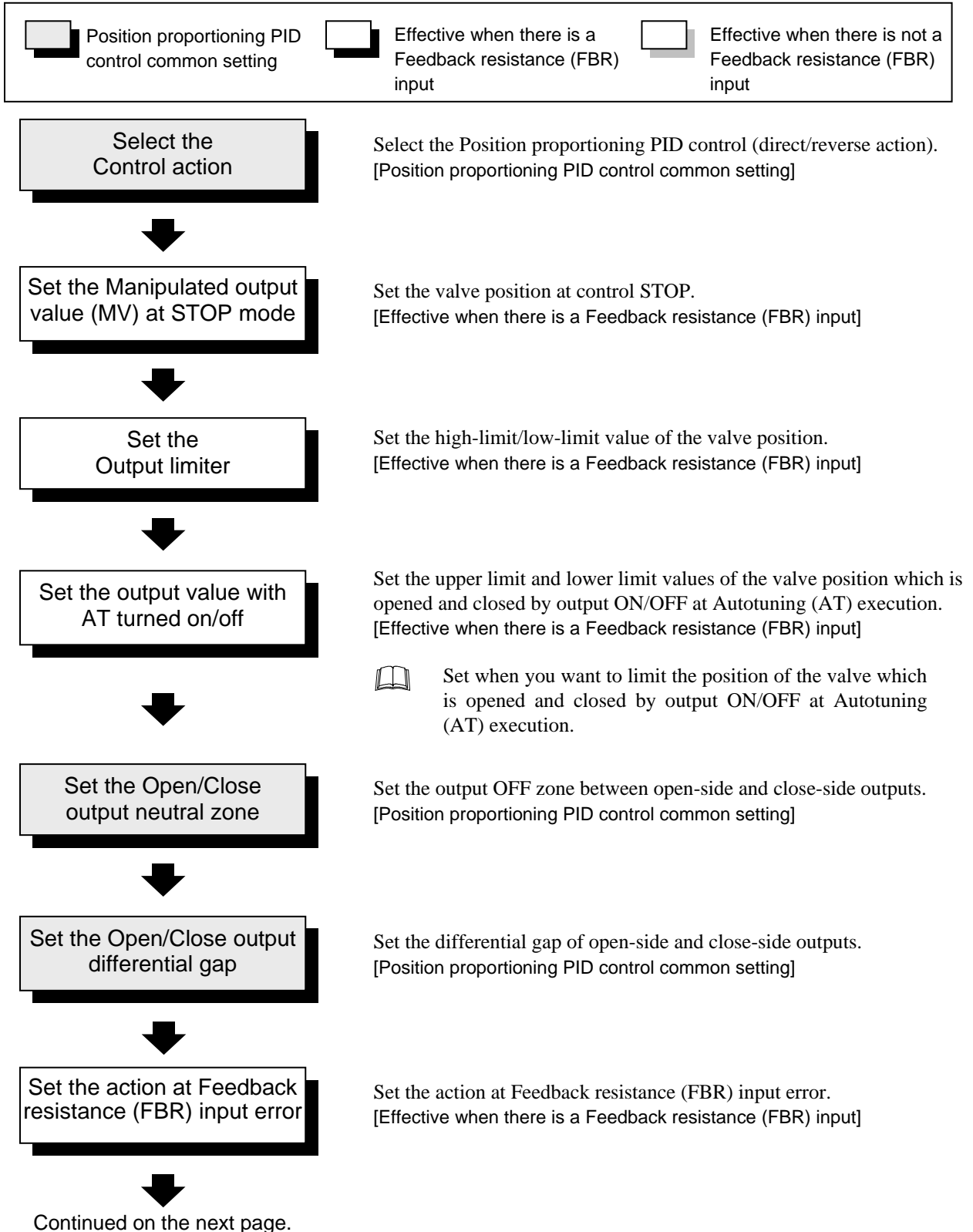

Continued from the previous page.

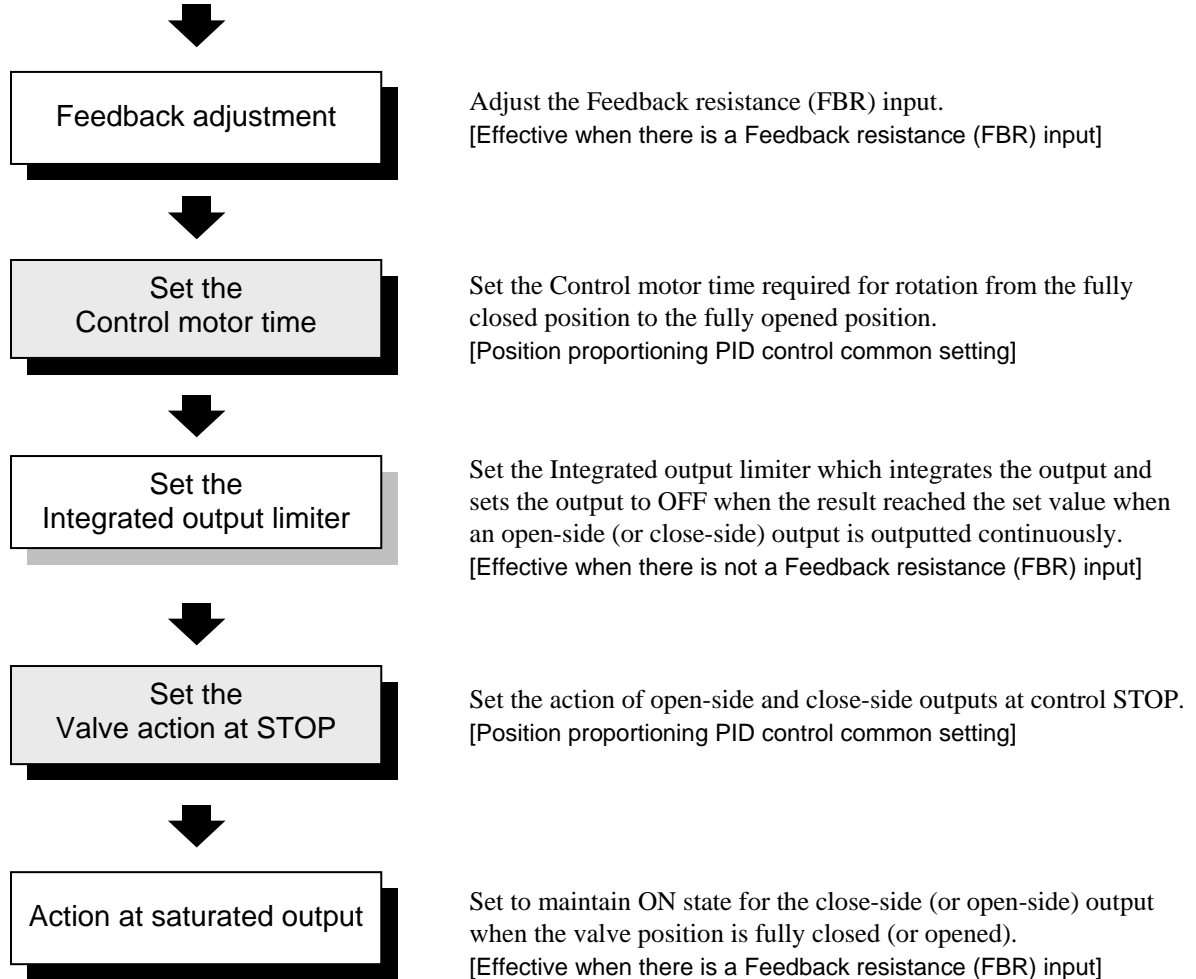

■ **Setting procedures**

● **When there is a Feedback resistance (FBR) input**

1. When set the parameter in Engineering mode, change the operation mode from RUN mode to STOP mode.

 To change from STOP mode to RUN mode, refer to **6.4 RUN/STOP Transfer (P. 6-11)**.

2. Press the Shift key while pressing the SET key for 2 seconds at PV/SV monitor screen until Engineering mode is displayed. Function block 10 screen is displayed first.

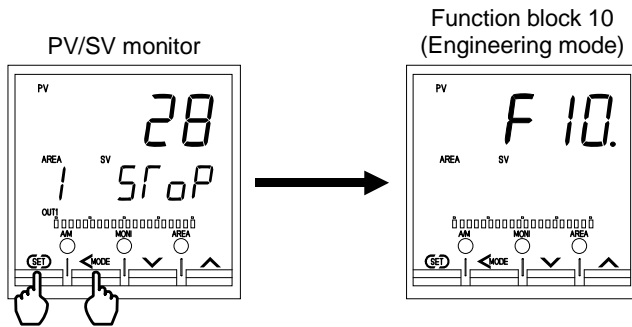

Press the shift key while pressing the SET key for 2 seconds

3. Press the UP or DOWN key until Function block 51 screen is displayed.

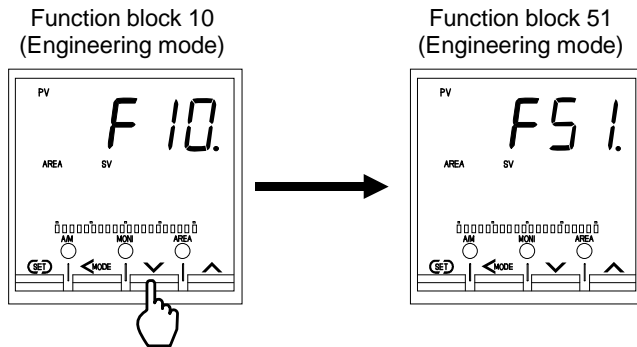

4. Press the SET key to change the control action setting screen.

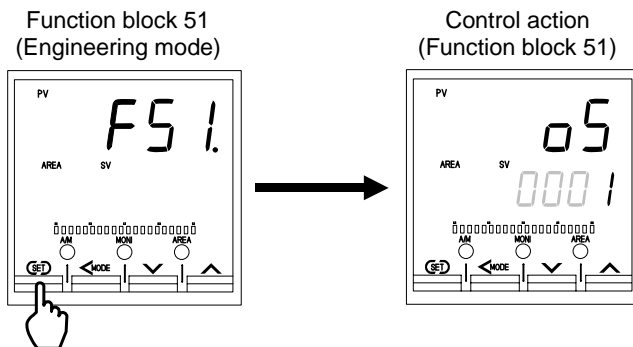

5. Press the UP key to change the control action from “1: PID control (reverse action)” to “5: Position proportioning PID control (reverse action).” Then, press the SET key to store the new value.

Control action
(Function block 51)

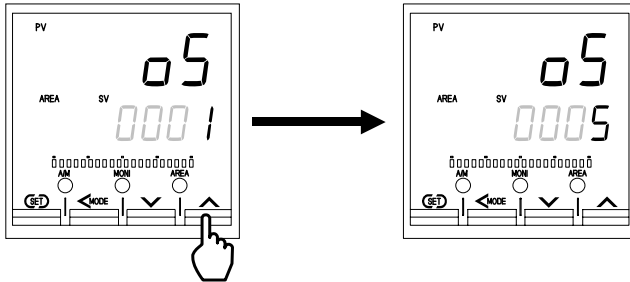

6. Set the following parameters Manipulated output value (MV1) at STOP mode, Output limiter high (MV1), and Output limiter low (MV1) in the same way as described above.

• **Manipulated output value (MV1) at STOP mode [Function block 51]**

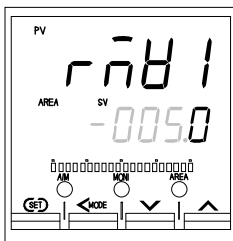

Set the valve position at control STOP.
Setting range: -5.0 to $+105.0$ %
(Factory set value: -5.0)

• **Output limiter high (MV1) [Function block 51]**

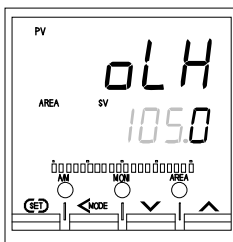

Set the high-limit value of the valve position.
Setting range: Output limiter low (MV1) to $+105.0$ %
(Factory set value: 105.0)

• **Output limiter low (MV1) [Function block 51]**

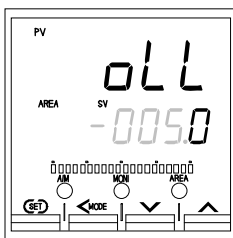

Set the low-limit value of the valve position.
Setting range: -5.0 % to Output limiter high (MV1)
(Factory set value: -5.0)

7. Set the parameters Output value with AT turned on and Output value with AT turned off after changing to the Function block 52 screen by key operation.



Set when you want to limit the position of the valve which is opened and closed by output ON/OFF at Autotuning (AT) execution.

• **Output value with AT turned on [Function block 52]**

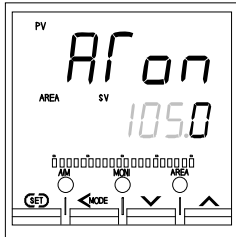

Set the upper limit values of the valve position (Feedback resistance input) which is opened and closed by output ON/OFF at Autotuning (AT) execution.

Setting range: Output value with AT turned off to 105.0 %
(Factory set value: 105.0)
However, within output limiter

• **Output value with AT turned off [Function block 52]**

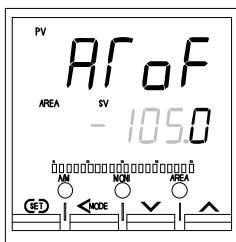

Set the lower limit values of the valve position (Feedback resistance input) which is opened and closed by output ON/OFF at Autotuning (AT) execution.

Setting range: -105.0 % to Output value with AT turned on
(Factory set value: -105.0)
However, within output limiter

8. Set the following parameters after changing to the Function block 53 screen.
Also, execute the feedback adjustment of the Feedback resistance (FBR) input.

- Open/Close output neutral zone
- Open/Close output differential gap
- Action at Feedback resistance (FBR) input error
- Control motor time
- Valve action at STOP
- Action at saturated output



The parameter display order is shown below.

Open/Close output neutral zone → Open/Close output differential gap → Action at Feedback resistance (FBR) input error → Feedback adjustment → Control motor time → Valve action at STOP → Action at saturated output

• **Open/Close output neutral zone [Function block 53]**

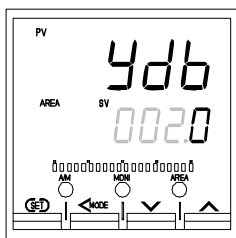

Set the output OFF zone between open-side and close-side outputs.

Setting range: 0.1 to 10.0 % of output
(Factory set value: 2.0)

Continued on the next page.

Continued from the previous page.

• **Open/Close output differential gap [Function block 53]**

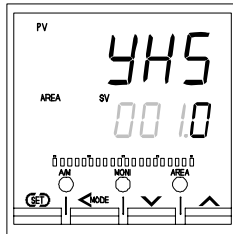

Set the differential gap of open-side and close-side outputs.
Setting range: 0.1 to 5.0 % of output
(Factory set value: 1.0)

• **Action at Feedback resistance (FBR) input error [Function block 53]**

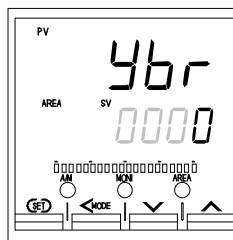

Set the action at Feedback resistance (FBR) input error.
Setting range: 0: Depending on the valve action at STOP
1: Control action continued
(Factory set value: 0)

For the feedback adjustment, refer to the next page.

• **Control motor time [Function block 53]**

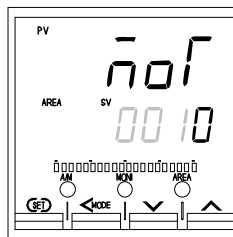

Set the Control motor time required for rotation from the fully closed position to the fully opened position.
Setting range: 5 to 1000 seconds
(Factory set value: 10)



If Feedback adjustment is performed, the control motor driving time is automatically computed. However, if the time thus computed is less than 5 seconds, no set value is updated.

• **Valve action at STOP [Function block 53]**

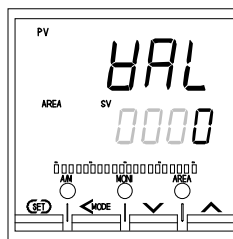

Set the action of open-side and close-side outputs at control STOP.
Setting range: 0: Close-side output OFF, Open-side output OFF
1: Close-side output ON, Open-side output OFF
2: Close-side output OFF, Open-side output ON
(Factory set value: 0)

• **Action at saturated output [Function block 53]**

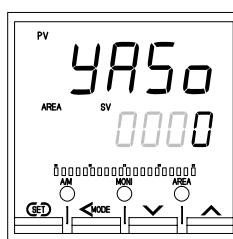

Set to maintain ON state for the close-side (or open-side) output when the valve position is fully closed (or opened).
Setting range: 0: Invalid (The close-side [or open-side] output turns to OFF when the valve position is fully closed [or opened]).
1: Valid (The close-side [or open-side] output remains ON state when the valve position is fully closed [or opened]).
(Factory set value: 0)

Continued on the next page.

Continued from the previous page.

• **Feedback adjustment [Function block 53]**

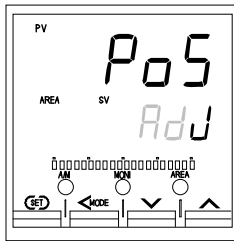

Adjust the Feedback resistance (FBR) input.
After the adjustment, the manipulated output value from 0 to 100 % obtained after PID computation matches the valve position signal of the fully closed position to the fully opened position [Feedback resistance (FBR) input] sent from the control motor.

At the adjustment preparation screen, press and hold the Shift key for 5 seconds to start the adjustment. The display automatically return to the adjustment preparation screen after the adjustment is completed.

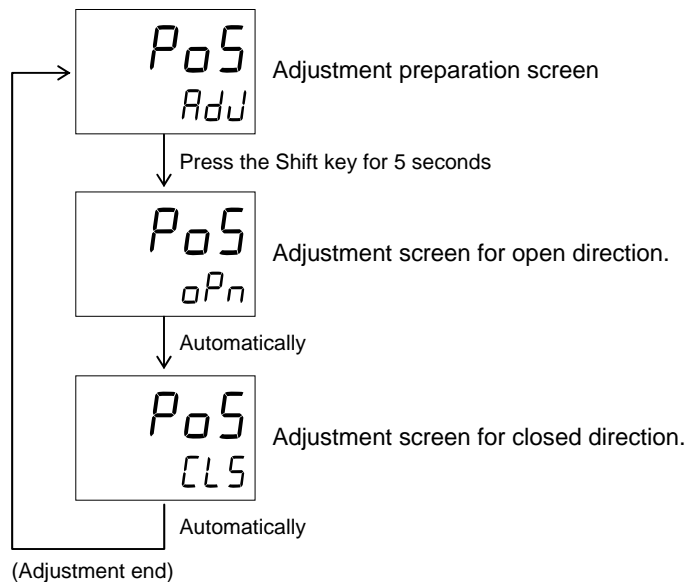

Display returns to the PV/SV monitor screen if no key operation is performed within 1 minute (except during the Feedback adjustment).

9. At the end of setting of each parameter and Feedback adjustment of the Feedback resistance (FBR) input, return to the PV/SV monitor screen and then refer to **6.4 RUN/STOP Transfer (P.6-11)** and set to the control RUN state.

- **When there is no Feedback resistance (FBR) input**

1. Refer to steps 1 to 5 (P. 6-44 to P. 6-45) of **When there is a Feedback resistance (FBR) input** and set the control action to Position proportioning PID control (direct or reverse action).
2. Refer to step 8 (P. 6-46) of **When there is a Feedback resistance (FBR) input** and set the Open/Close output neutral zone, Open/Close output differential gap, Control motor time, and Valve action at STOP. In addition, also set Integrated output limiter.



The parameter display order is shown below.

Open/Close output neutral zone → Open/Close output differential gap → Control motor time → Integrated output limiter → Valve action at STOP

- **Integrated output limiter [Function block 53]**

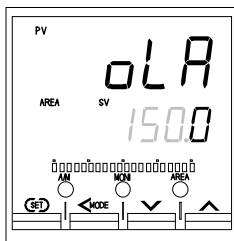

Set the Integrated output limiter which integrates the output and sets the output to OFF when the result reached the set value when an open-side (or close-side) output is outputted continuously.

Setting range: 0.0 to 200.0 % of control motor time

0.0: Integrated output limiter function OFF

(Factory set value: 150.0)



Since the output is integrated when the open-side (or close-side) output is outputted continuously, once the inverted output is outputted, the integrated value is reset.

[Example] If control is started at the fully closed state when the Control motor operation time is set at 10 seconds and the Integrated output limiter value is set at 100 %, the following results.

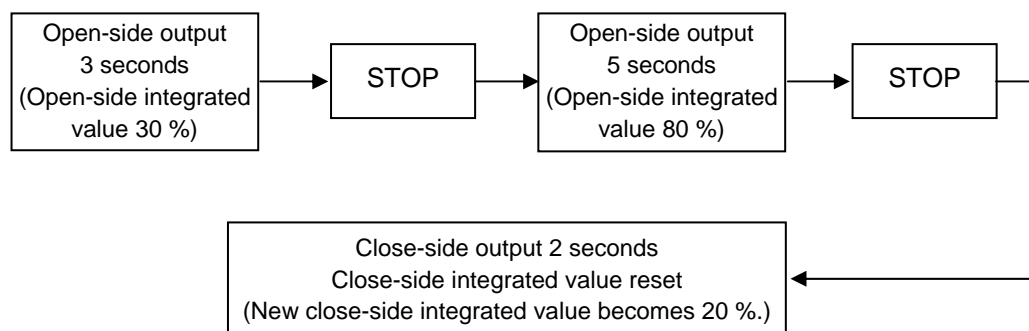

3. At the end of setting of each parameter, return to the PV/SV monitor screen and then refer to **6.4 RUN/STOP Transfer (P. 6-11)** and set to the control RUN state.

6.13 Ramp/Soak Control

Ramp/Soak control of this instrument realizes simple Ramp/Soak control by linking a number of memory areas having different Set values (SV).

Simple Ramp/Soak control is possible by setting a Set value (SV), Setting change rate limiter (up/down), Area soak time, and Link area number in each memory area.

- Set value (SV): Sets the fixed set point control (control by fixed set value) desired value of each memory area.
- Setting change rate limiter: Sets the slope of the Set value (SV) which is raised or lowered at each unit time.
- Area soak time: Sets the fixed set point control time of each memory area.
- Link area number: Sets the memory area numbers for linking the corresponding memory areas.



Besides the above, the Setting change rate limiter unit time and Area soak time unit are set in the Engineering mode.

Example: Ramp/Soak control by linking Memory area 1 to 3

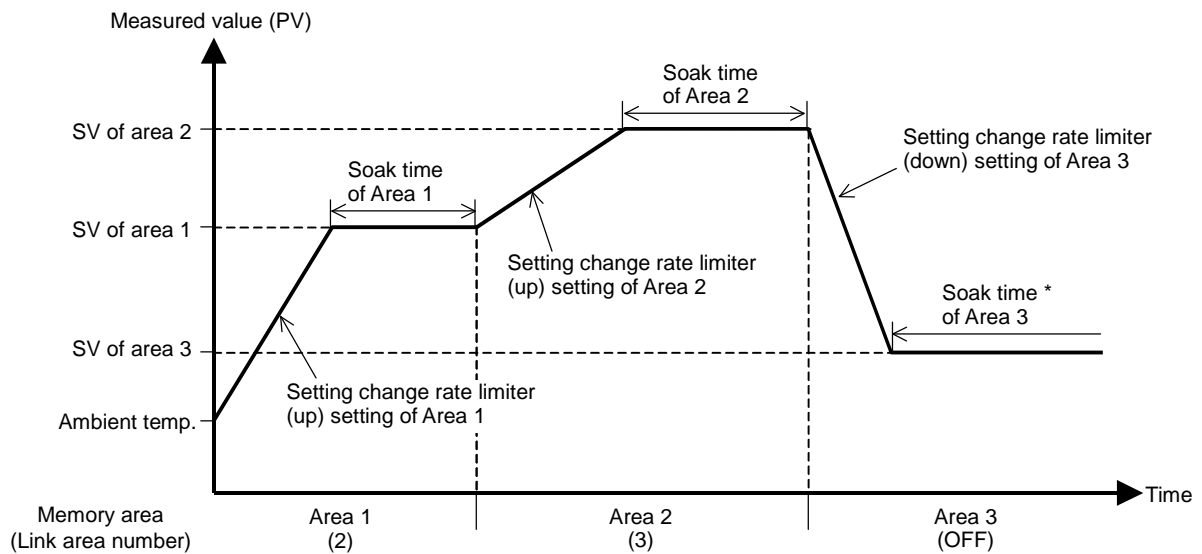

* As the area soak time for memory area linked last becomes invalid, the state of SV3 reached continues.

■ Operation flowchart

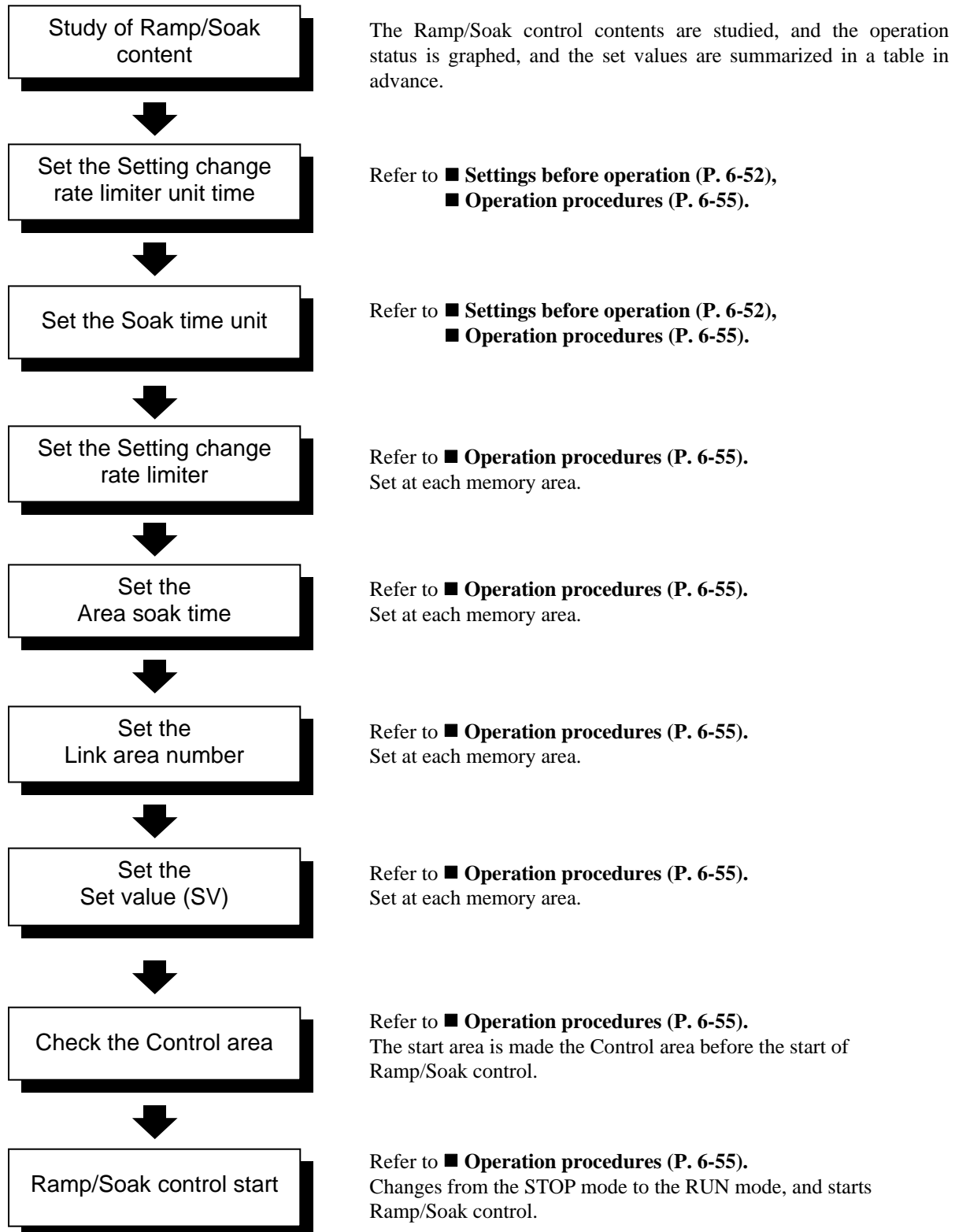

■ Settings before operation

When implementing Ramp/Soak control, it may be necessary to set the following items in advance.

- Setting change rate limiter unit time [Engineering mode: Function block 70]
- Soak time unit [Engineering mode: Function block 70]

1. Change the operation mode from RUN mode to STOP mode.

 To change from RUN mode to STOP mode, refer to **6.4 RUN/STOP Transfer (P. 6-11)**.

2. Press the Shift key while pressing the SET key for 2 seconds at PV/SV monitor screen until Engineering mode is displayed. Function block 10 screen is displayed first.

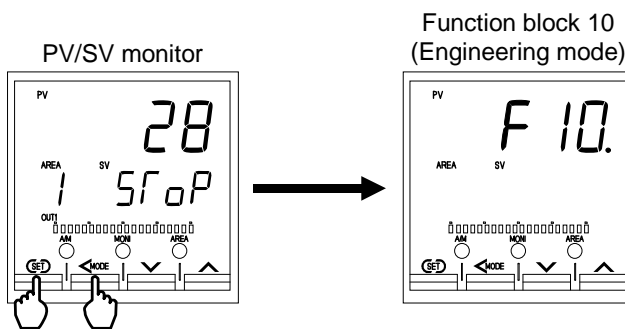

Press the Shift key while pressing the SET key for 2 seconds

3. Press the UP or DOWN key until Function block 70 screen is displayed.

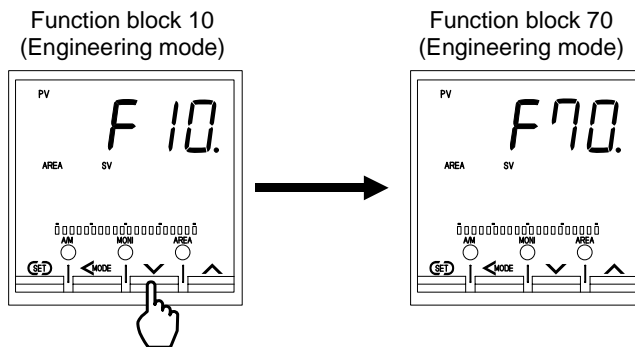

4. Press the SET key to change the screen to the Setting change rate limiter unit time setting screen.

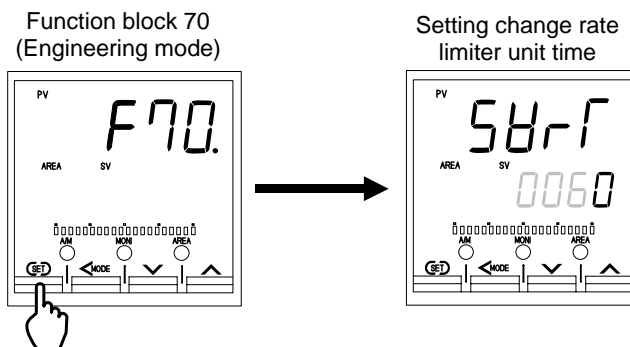

5. Set the Setting change rate limiter [amount of change of the Set value (SV) per unit time when the Set value (SV) is changed] by pressing the Shift key and the UP key or DOWN key.
If unnecessary to be changed, use their factory set values.

Setting range: 1 to 3600 seconds (Factory set value: 60)

Setting change rate limiter unit time

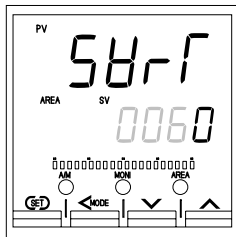

Setting example:

- SV (°C)/sec. → Set 1 second
- SV (°C)/min. → 60 seconds (factory set value)
- SV (°C)/30 min. → Set 1800 seconds
- SV (°C)/hour. → Set 3600 seconds



After a new value is displayed on the display by using UP and DOWN keys, if no key operation is performed within 1 minute without pressing SET key, this instrument returns to the PV/SV monitor screen and the Setting change rate limiter unit time will not be changed.

6. Press the SET key to store the new Setting change rate limiter unit time.
The screen goes to the Soak time unit.

Setting change rate limiter unit time

Soak time unit

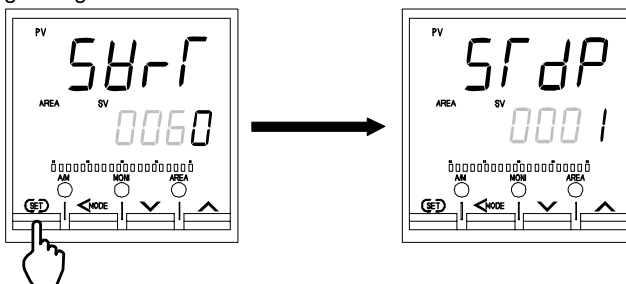

7. Select the Area soak time unit which needs to be changed by pressing the UP or DOWN key.
If unnecessary to be changed, use their factory set values.

Setting range: 0: 0 time 00 minute to 99 times 59 minutes
1: 0 minute 00 second to 199 minutes 59 seconds
(Factory set value: 1)

Soak time unit

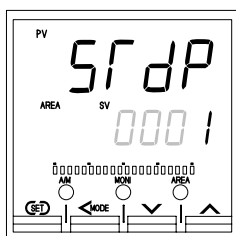

After a new value is displayed on the display by using UP and DOWN keys, if no key operation is performed within 1 minute without pressing SET key, this instrument returns to the PV/SV monitor screen and the time unit of the Area soak time will not be changed.

- Press the SET key to store the new time unit of the Area soak time.
The screen returns to the first parameter (Function block 70).

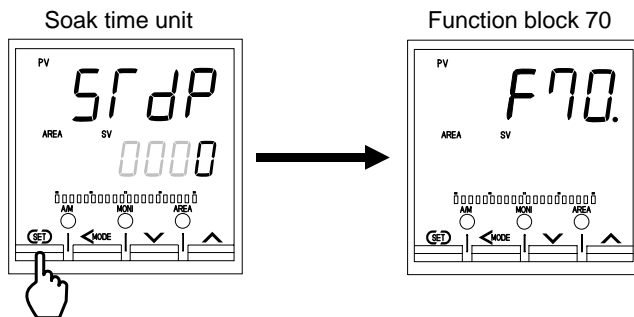

- To return the PV/SV monitor, press the MONI key (for direct key type 1), or press the Shift key while pressing the SET key.

■ Operation procedures

This section uses the following sample of Ramp/Soak control to describe the operation procedures.

[Example: Ramp/Soak control by linking Memory area 1 to 3]

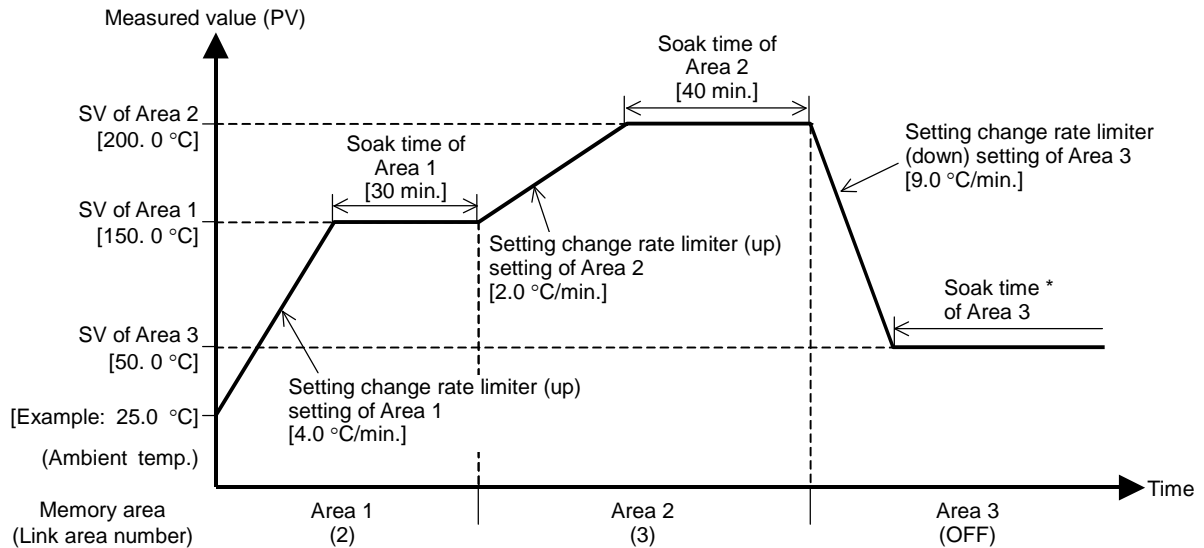

	Area 1	Area 2	Area 3
Set value (SV)	150.0 °C	200.0 °C	50.0 °C
Setting change rate limiter (up) [SVrU]	4.0 °C/min. (60 sec.)	2.0 °C/min. (60 sec.)	OFF
Setting change rate limiter (down) [SVrd]	OFF	OFF	9.0 °C/min. (60 sec.)
Area soak time [AST]	30 min.	40 min.	0 min. *
Link area number [LnKA]	2	3	OFF

* In this example, the Area soak time for memory area 3 is set. However, as the Area soak time for the memory area linked last becomes invalid, the state of SV3 reached continues.

Step 1:
Study the Ramp/Soak control content.

The Ramp/Soak control contents are studied and Ramp/Soak status is graphed and the set values of each memory area are summarized in a table as shown above.

Step 2:
Set the Setting change rate limiter unit time and Soak time unit of function block 70.

Refer to ■ **Settings before operation (P. 6-52)** and set the Setting change rate limiter unit time and Area soak time (In this example, the factory set values are used for both). Since control stops (STOP) at this time, go directly to the next step.

- Setting change rate limiter unit time (SVrT): 60 seconds [factory set value]
- Soak time unit (STdP): 1 (0 minutes 00 seconds to 199 minutes 59 seconds) [factory set value]

Step 3:

Set the Setting change rate limiter, Area soak time and Link area number to each of Memory area 1, 2 and 3.

1. Press the SET key at Parameter setting mode until Setting change rate limiter (up) setting screen is displayed.

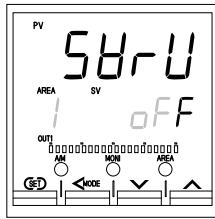

Factory set value:
OFF (Unused)

2. Press the UP key to change the number to 4.0.

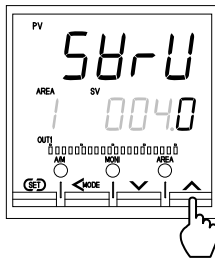

3. Press the SET key to store the new value. The display goes to the next parameter. Check that this screen is set to OFF.

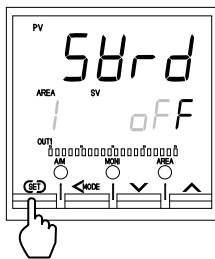

Factory set value:
OFF (Unused)

4. Press the SET key until Area soak time setting screen is displayed.

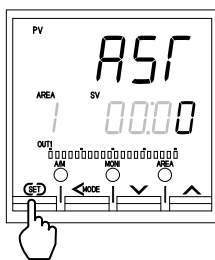

Factory set value:
0 min. 00 sec.

5. Press the Shift key to high-light the tens place of "minute."

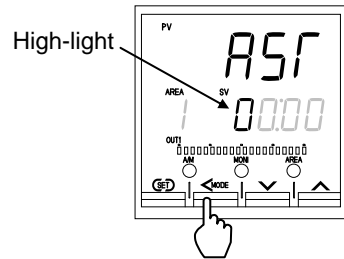

6. Press the UP key to change the number to 3.

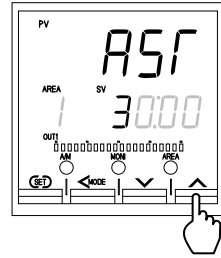

7. Press the SET key to store the new value. The display goes to the next parameter.

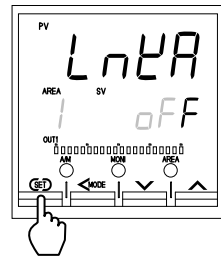

Factory set value:
OFF (No link)

8. Press the UP key and change the Memory area 1 Link area number to 2.

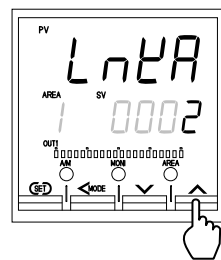

9. Press the SET key to store the new value. The display goes to the next parameter.

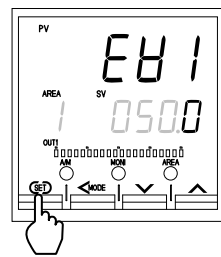

10. Set the Memory area 2.

Press the SET key several times until Setting change rate limiter (up) setting screen is displayed. The screen set at step 2 (P. 6-56) is displayed.

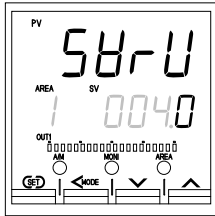
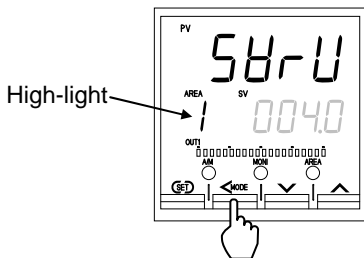
**11. Press the Shift key until Memory area display unit is high-lighted.****12. Press the UP key to change to 2. Area number display flashes. ***

* The area number display flashes to indicate that the area number now displayed differs from the control area.

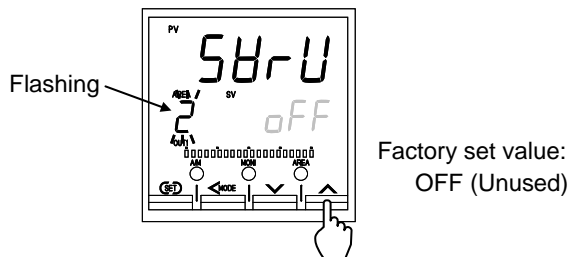
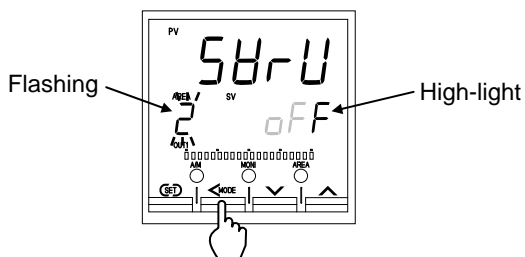
**13. Press the Shift key to high-light the least significant digit.****14. Set the Memory area 3 Setting change rate limiter, Area soak time, and Link area number by the same procedures as described in steps 3 to 9 (P. 6-56).****15. Set the Memory area 3.**

Press the SET key several times until Setting change rate limiter (up) setting screen of the Memory area 2 is displayed.

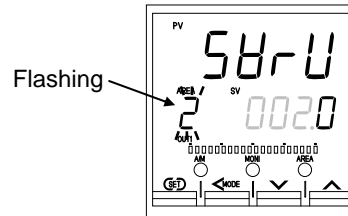
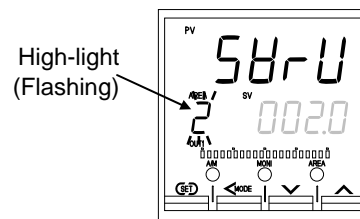
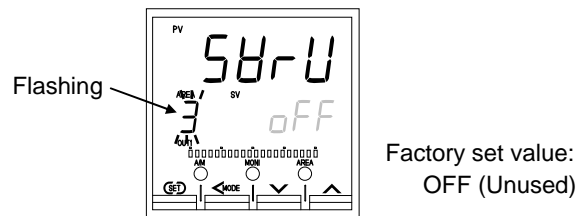
**16. Press the shift key to high-light (flashing) the Memory area display unit.****17. Press the UP key to change to 3. Area number display flashes.****18. Set the Memory area 3 Setting change rate limiter, Area soak time, and Link area number by the same procedures as described in steps 3 to 9 (P. 6-56). However, in the case of this Ramp/Soak control sample, the area soak time is invalid, even if set, because Memory area 3 is linked last.**

Step 4:
Set the SV to each of Memory area 1, 2 and 3.

1. Press and hold the SET key for 2 seconds to change the mode from Parameter setting mode to SV setting & monitor mode. PV/SV monitor screen is displayed.

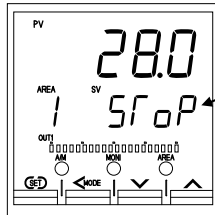

STOP display because control is stopped



Changed to the SV setting & monitor mode even if the Shift key is pressed while pressing the SET key. When the Direct key is type 1, the mode can also be changed to the SV setting & monitor mode by pressing the MONI key.

2. Press the SET key until Set value (SV) setting screen of Memory area 1 is displayed.

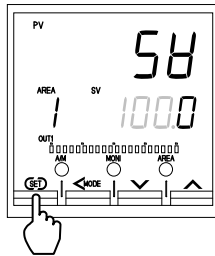

3. Press the Shift key to high-light the tens place.

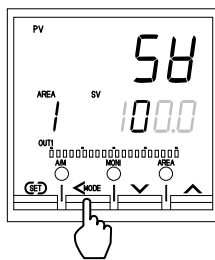

4. Press the UP key to change the number to 5.

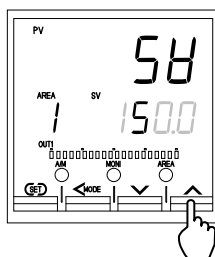

5. Press the SET key to store the new value. The display goes to the next parameter.

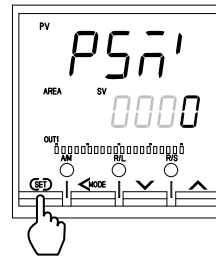

Example:
Manipulated output value at MV transfer screen

6. Set the Set value (SV) of Memory area 2. Press the SET key several times until Set value (SV) setting screen of Memory area 1 is displayed. The screen set at step 4 (P. 6-58) is displayed.

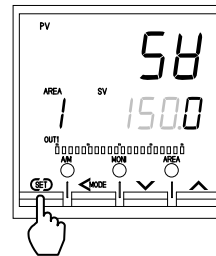

7. Press the Shift key to high-light the Memory area display unit.

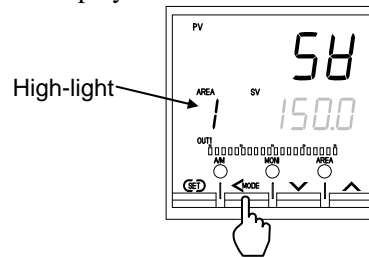

8. Press the UP key to change the number to 2. The number in AREA (Area number) display flashes.

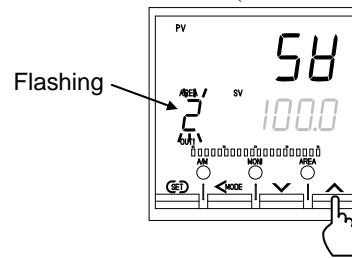

9. Press the Shift key to high-light the hundreds place.

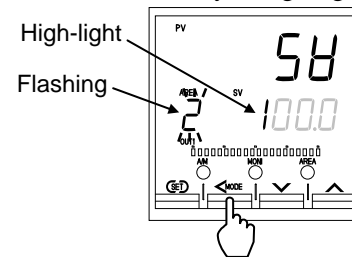

10. Hereinafter, set the Memory areas 2 and 3 Set value (SV) by the same procedure.

Step 5:
Check the control area number.

- **For Direct key Type 1**

Press the AREA key until Memory area transfer screen is displayed.

Check that the memory area at the time of operation start corresponds to Memory area 1.

- **For Direct key Type 2**

Press the SET key several times at SV setting & monitor mode until Memory area transfer setting screen is displayed. Check that the memory area at the time of operation start corresponds to Memory area 1.

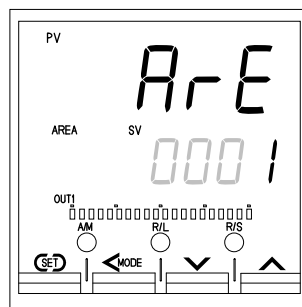

Memory area transfer setting screen

Step 6:
Change from STOP mode to RUN mode

When **6.4 RUN/STOP Transfer (P. 6-11)** is referenced and the control RUN state is selected, Ramp/Soak control starts.

6.14 Group Operation by the Intercontroller Communication

Intercontroller communication exchanges data between multiple FB400/900 (hereinafter referred to as “controller”) without using remote setting input and analog output and other analog signals and host computer communications.

The following four functions become usable when the Intercontroller communication is used.

- Group RUN/STOP function
- Automatic temperature rise function (with learning function)
- Cascade control function
- Ratio setting function

CAUTION

- Since Intercontroller communication communicates by connecting multiple controllers (FB400/900), a time lag (maximum 70 ms × number of controllers connected) is always generated. Therefore, it may be impossible to cope with rapid response control systems. When performing Intercontroller communication, consider the operation delay caused by the time lag.
- Since Intercontroller communication recognizes the connected controllers when the power is turned OFF → ON, be sure that power to all the controllers engaged in Intercontroller communication is turned ON at the same time.

6.14.1 Wiring method of the Intercontroller communication

In Intercontroller communication, perform multi-drop connection using the communication 2 port (COM2).

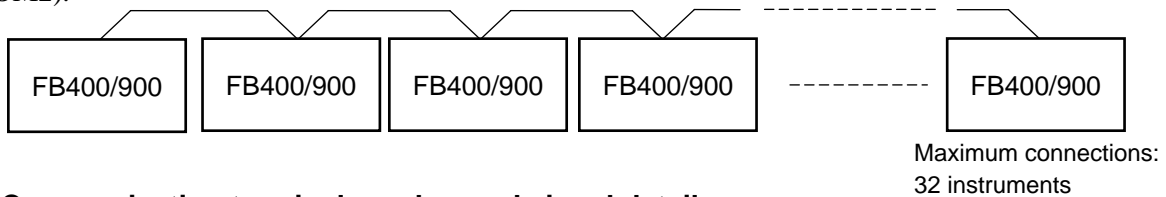

• Communication terminal number and signal details

Terminal No.	Signal name	Symbol
25	Signal ground	SG
28	Send data/Receive data	T/R (A)
29	Send data/Receive data	T/R (B)

• Wiring method

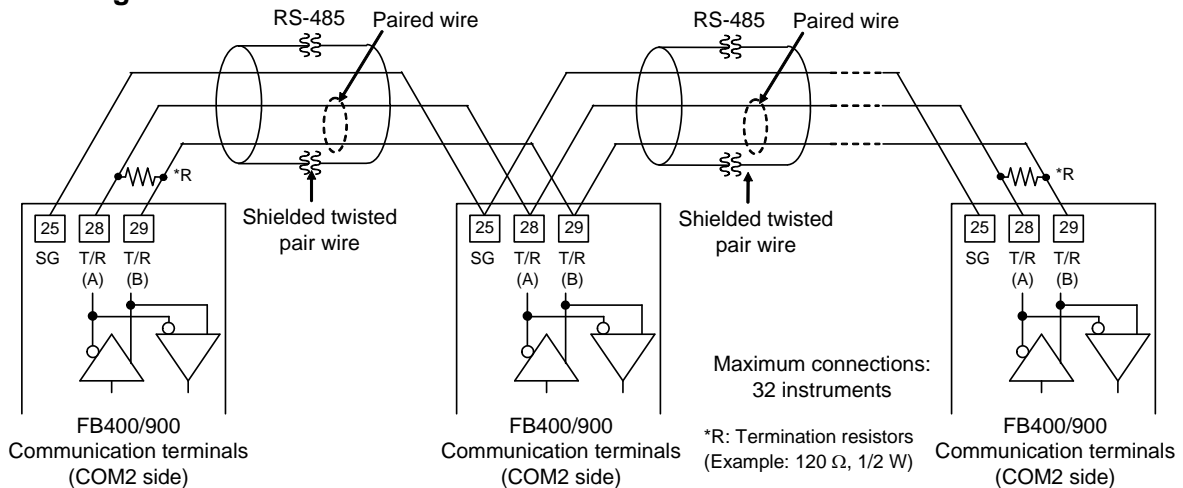

6.14.2 Common setting of the Intercontroller communication

When performing Intercontroller communication, Device address 2 must be set for all the controllers engaged in the Intercontroller communication.

● Set the Device address 2

1. Press the Shift key while pressing the SET key at PV/SV monitor screen until Setup setting mode is displayed. The screen displayed first differs depending on the specification.

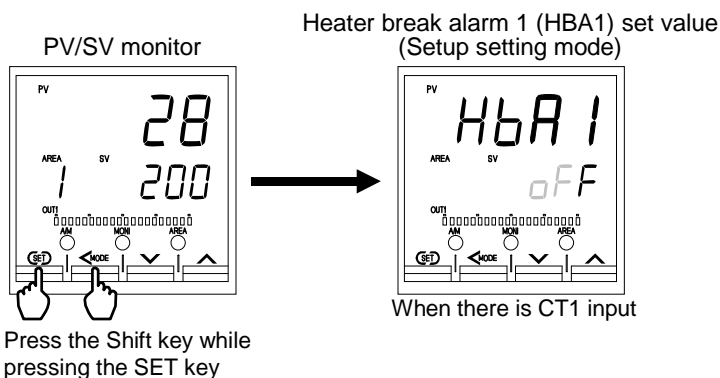

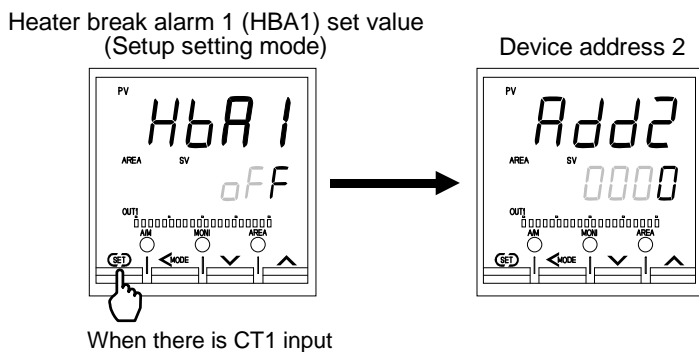

2. Press the SET key until Device address 2 screen is displayed.

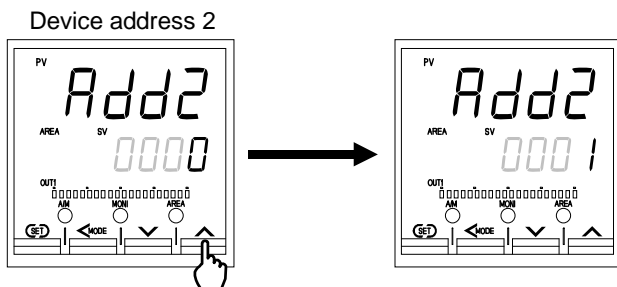

3. Set the address by pressing the UP or DOWN keys.

Setting range: 0 to 31 (Factory set value: 0)



 Always set the address of each controller to the number in succession starting from 0.



After a new value is displayed on the display by using UP and DOWN keys, if no key operation is performed within 1 minute without pressing SET key, this instrument returns to the PV/SV monitor screen and the address will not be changed.

4. Press the SET key to store the new address. The screen goes to the next parameter.

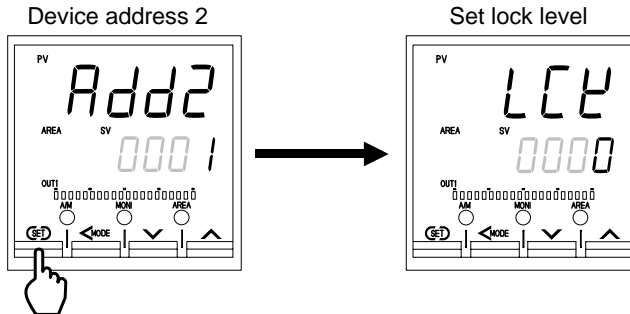

5. To return the PV/SV monitor, press the MONI key (for Direct key Type 1), or press the Shift key while pressing the SET key.
6. Set the address of the other controllers by the same procedures as described in steps 1 to 5 above.







When performing Intercontroller communication, the Communication 2 protocol (Engineering mode: function block 60) setting must be “2: Intercontroller communication.” Since the Communication 2 protocol shipping value is “2: Intercontroller communication,” resetting is unnecessary. However, when Intercontroller communication cannot be executed successfully, check the Communication 2 protocol setting.



When Intercontroller communication is performed, the setup screen related to communication 2 other than Device address 2 (Communication speed 2, Data bit configuration 2, and Interval time 2) is not displayed.

6.14.3 Group RUN/STOP function

The group RUN/STOP function makes multiple controllers one group and if even one controller in the group is set to the RUN/STOP state, it places all the controllers in that group into the RUN/STOP state.

-  When executing group RUN/STOP at Intercontroller communication, a time lag (maximum $70 \text{ ms} \times \text{number of controllers connected}$) up to actual transfer after operation is generated. For example, when RUN/STOP operation is repeated by different controllers in a short time, the last operation and actual controller state may be different. Therefore, be especially careful of the RUN/STOP transfer timing.
-  The group RUN/STOP function by Intercontroller communication can be executed when the Communication 2 port (COM2) is usable.
-  The maximum number of connectable controllers at Intercontroller communication is 32, without regard to the number of groups.
-  When the group RUN/STOP function is used at automatic temperature rise by Intercontroller communication, all the controllers in the group can start temperature rise simultaneously.

■ Operation flowchart

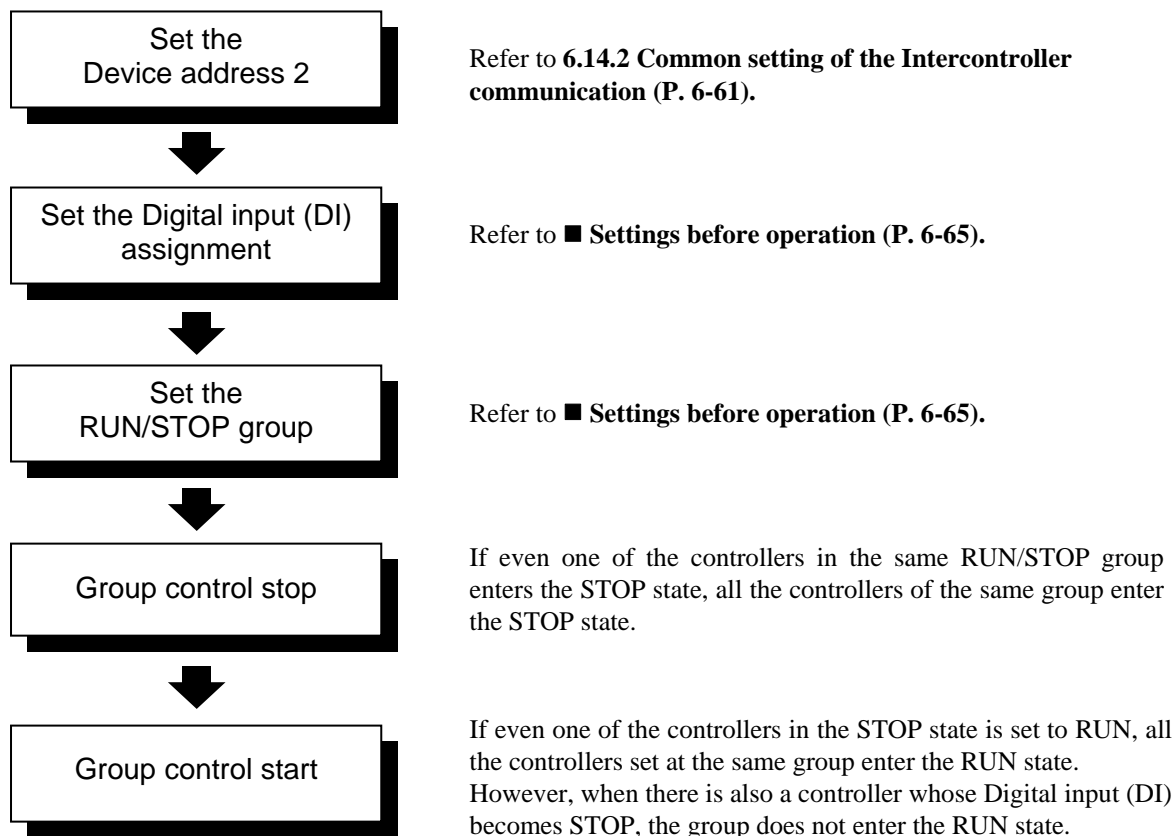

-  For each status by RUN/STOP operation, refer to **■ Group RUN/STOP operation and states (P. 6-64)** and **■ Usage example (P. 6-69)**.

■ Requirements for Group RUN/STOP

● Control stop (STOP) by group RUN/STOP condition

If there is even one controller in the same group, when STOP is selected by Key operation, Communication, or Digital input (DI), it enters the STOP state.

● Control start (RUN) by group RUN/STOP condition

If there is even one controller in the same group, when RUN is selected by Key operation, Communication, or Digital input (DI), it enters the RUN state.

However, if there is even one controller whose Digital input (DI) becomes STOP, it does not enter the RUN state.



When RUN/STOP selection by Digital input (DI) and RUN/STOP selection by key operation or communication are different, the STOP state is entered. (STOP priority)

■ Group RUN/STOP operation and states

The actual RUN/STOP state is different for RUN/STOP by Key operation, Digital input, and Communications. The following shows the relationship between each operation and the actual RUN/STOP state.

● When there is no RUN/STOP transfer by the digital input (DI)

RUN/STOP mode from key operation or communication	Actual RUN/STOP mode state	State of STOP character display
STOP	STOP	STOP (SToP)
RUN	RUN	STOP is not displayed

● When there is RUN/STOP transfer by the digital input (DI)

RUN/STOP mode from key operation or communication	RUN/STOP mode by Digital input (DI)	Actual RUN/STOP mode state	State of STOP character display
STOP	Contact open (STOP)	STOP	STOP (SToP)
	Contact closed (RUN)		KSTOP (KSTP)
RUN	Contact open (STOP)	RUN	dSTOP (dSTP)
	Contact closed (RUN)		STOP is not displayed



Other than those above, the actual RUN/STOP state and STOP display may be different, depending on the RUN/STOP state by Digital input (DI) of the other controllers in the same group.

RUN/STOP mode from key operation or communication	RUN/STOP mode by Digital input (DI)	RUN/STOP selection by digital input (DI) of other controllers in the same group.	Actual RUN/STOP mode state	State of STOP character display
RUN	Contact close (RUN) or Without DI	STOP	STOP	GSTOP (GSTP)

Refer to ■ Usage example (P. 6-69).

■ Settings before operation

When implementing the group RUN/STOP function, the following items must be set.

- Device address 2 [Setup setting mode]
- Digital input (DI) assignment [Engineering mode: Function block 23]
- RUN/STOP group [Engineering mode: Function block 55]

☞ For the Device address 2 setting, refer to **6.14.2 Common setting of the Intercontroller communication (P. 6-61)**.

1. Change the operation mode from RUN mode to STOP mode.

☞ To change from RUN mode to STOP mode, refer to **6.4 RUN/STOP Transfer (P. 6-11)**.

2. Press the Shift key while pressing the SET key for 2 seconds at PV/SV monitor screen until Engineering mode is displayed. The Function block 10 screen is displayed first.

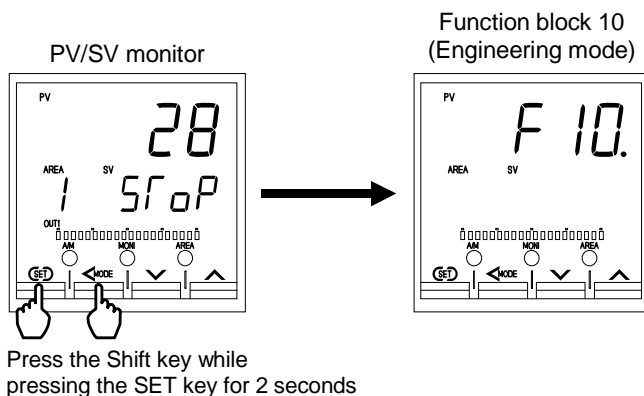

3. Press the UP or DOWN key until Function block 23 screen is changed.

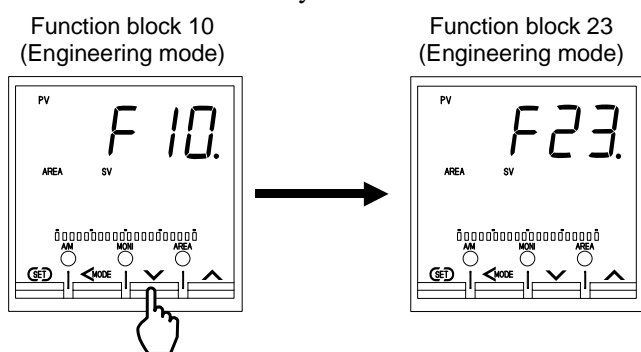

- Press the SET key to change the Digital input (DI) assignment screen.

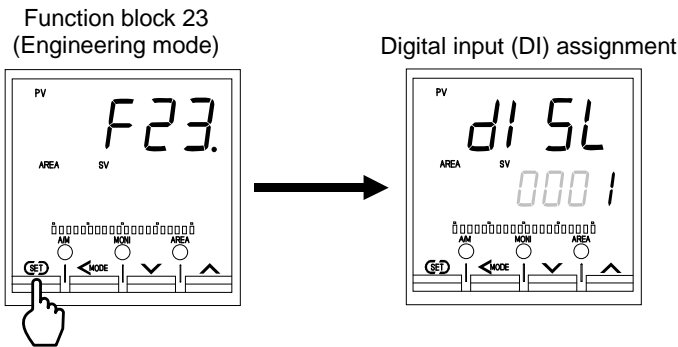

- Set the Digital input (DI) assignment by pressing the UP or DOWN keys. When performing RUN/STOP transfer by Digital input (DI), set “6.” Set “2,” “3,” or “4” only when using with functions other than RUN/STOP transfer. Setting range: 1 to 8 (Factory set value: 1)

Digital input (DI) assignment

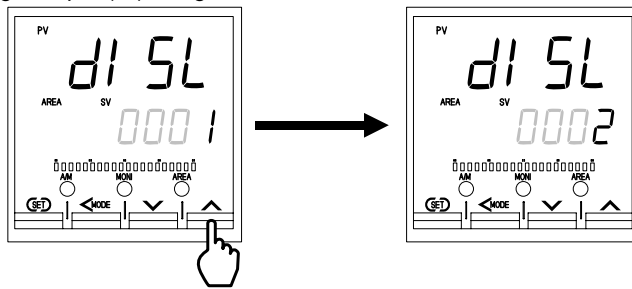

Set value	DI1	DI2	DI3	DI4	DI5	DI6	DI7
1	Memory area number selection (1 to 8)				Unused		
2					RUN/STOP	REM/LOC	AUTO/MAN
3					RUN/STOP	REM/LOC	Interlock release
4					RUN/STOP	AUTO/MAN	
5					REM/LOC	AUTO/MAN	
6					RUN/STOP	Unused	
7					REM/LOC		
8					AUTO/MAN		

- When performing group RUN/STOP transfer by Digital input (DI), wiring conservation and simple operation are possible by setting “RUN/STOP transfer by Digital input (DI)” for only one controller in the group.**
- After a new value is displayed on the display by using UP and DOWN keys, if no key operation is performed within 1 minute without pressing SET key, this instrument returns to the PV/SV monitor screen and the Digital input (DI) assignment will not be changed.
- For the Digital input (DI) assignment, refer to **7.5 Engineering Mode (P. 7-78)**.

6. Press the SET key to store the new Digital input (DI) assignment. The screen goes to the Function block 23 screen.

Digital input (DI) assignment

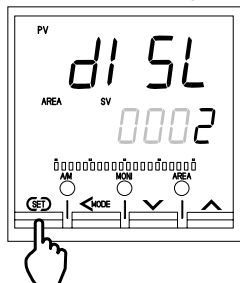

Function block 23

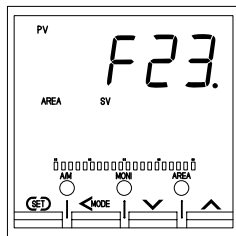

7. Press the UP or DOWN key until Function block 55 screen is displayed.

Function block 23
(Engineering mode)

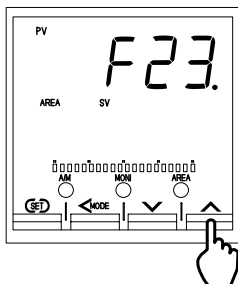

Function block 55
(Engineering mode)

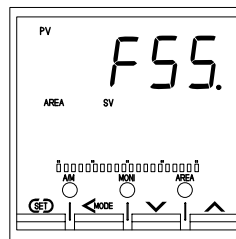

8. Press the SET key until RUN/STOP group setting screen is displayed.

Function block 55
(Engineering mode)

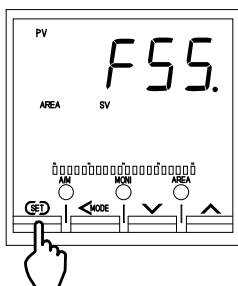

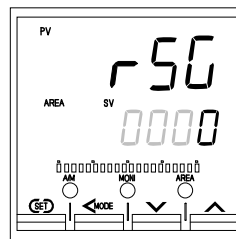

RUN/STOP group

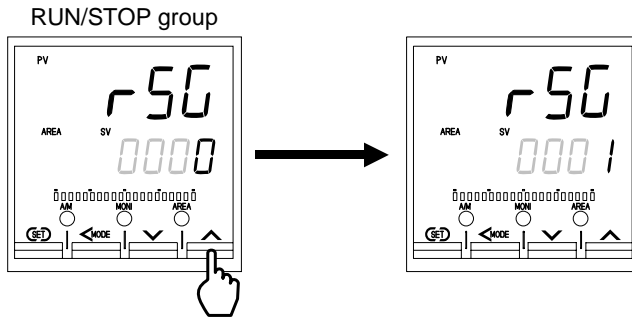

9. Set the RUN/STOP group number by pressing the UP or DOWN keys.

Setting range: 0 to 16 (Factory set value: 0)



-  When the group number is set to “0,” the group RUN/STOP state of that controller becomes OFF.
-  After a new value is displayed on the display by using UP and DOWN keys, if no key operation is performed within 1 minute without pressing SET key, this instrument returns to the PV/SV monitor screen and the RUN/STOP group number will not be changed.

10. Press the SET key to store the new RUN/STOP group number. The screen goes to the next parameter.

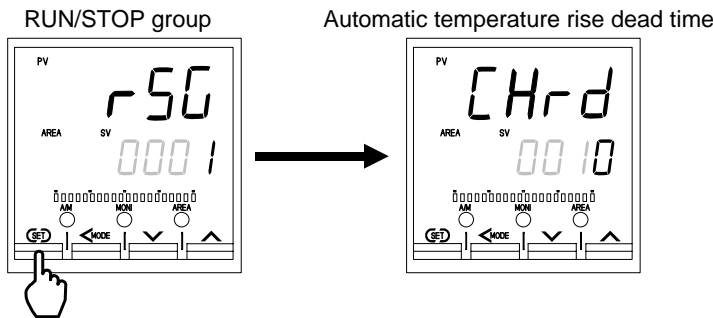

11. To return the PV/SV monitor, press the MONI key (for direct key type 1), or press the Shift key while pressing the SET key.

12. Set Digital input (DI) assignment and RUN/STOP group number of other controllers by the same procedure as that described in steps 1 to 11 above.

■ Usage example

When performing RUN/STOP by making 3 controllers one group.

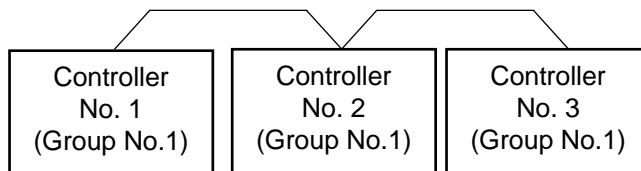

Connection status of the Intercontroller communication



The parts which become “DI” in the following description specify “RUN/STOP transfer by digital input (DI).”

● Example 1: RUN/STOP by key operation

The following key operations perform the same action whether or not there is DI. The display at STOP is different when there is and when there isn't DI.

[When all 3 controllers do not have DI]

1. When controller No. 1 to 3 are in the RUN state, if any one of the controllers is placed into the STOP state by key operation, all the controllers in that group enter the STOP state.

STOP display at control STOP

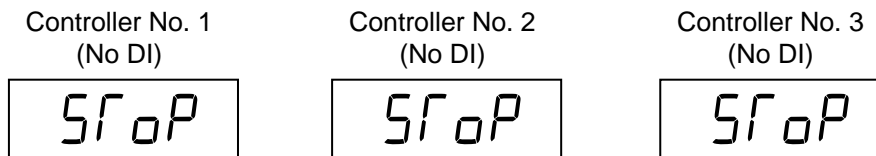

2. If any one of controller No. 1 to 3 is placed into the RUN state by key operation, all the controllers in that group enter the RUN state.

[When only controller No. 1 has DI]

1. When controller No. 1 to 3 are in the RUN state, if any one of the controllers is placed into the STOP state by key operation, all the controllers in that group enter the STOP state.

STOP display at control STOP

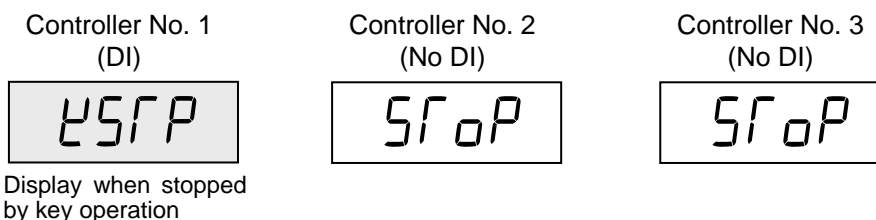

Display when stopped by key operation

2. If any one of controller No. 1 to 3 is placed into the RUN state by key operation, all the controllers in that group enter the RUN state.

[When controller No. 1 and No. 2 have DI]

1. When controller No. 1 to 3 are in the RUN state, if any one of the controllers is placed into the STOP state by key operation, all the controllers in that group enter the STOP state.

STOP display at control STOP

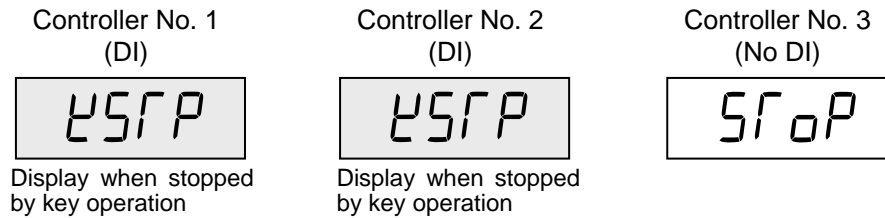

2. If any one of controller No. 1 to 3 is placed into the RUN state by key operation, all the controllers in that group enter the RUN state.

● **Example 2: RUN/STOP by DI**

[When controller No. 1 has DI]

(Controller No. 2, 3: May have or not have DI)

1. When controller No. 1 to 3 are in the RUN state, if the Digital input (DI) of controller No. 1 is transferred to the STOP state (contact closed → contact open), all the controllers in that group enter the STOP state.

STOP display at control STOP

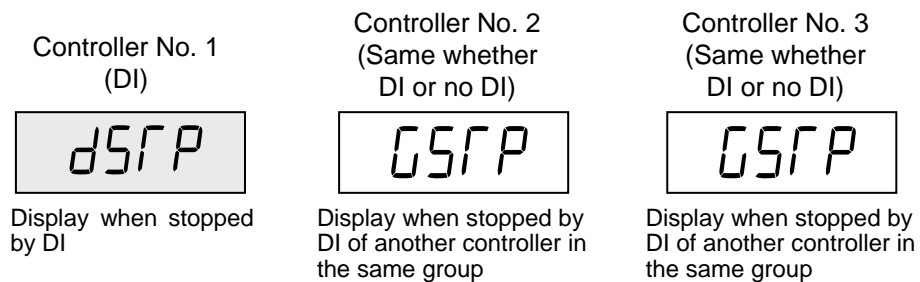

When stopped by DI, that group does not enter the RUN state as long as the operated DI is not set to RUN. Therefore, the STOP display is changed so that the controller that operated DI is known.

2. When the Digital input (DI) of controller No. 1 is transferred to the RUN state (contact open → contact closed), all the controllers of the same group enter the RUN state.



When performing group RUN/STOP transfer by Digital input (DI), wiring conservation and simple operation are possible by setting “RUN/STOP transfer by Digital input (DI)” for only one controller in the group.



When RUN/STOP by key operation and RUN/STOP by DI overlapped, the following occurs.

[When stopped by DI after STOP by key operation]

- Thereafter, when the Digital input (DI) of controller No. 1 is transferred to STOP, the STOP display changes while the STOP state remains unchanged. (When only controller No. 1 has DI)

STOP display at control STOP

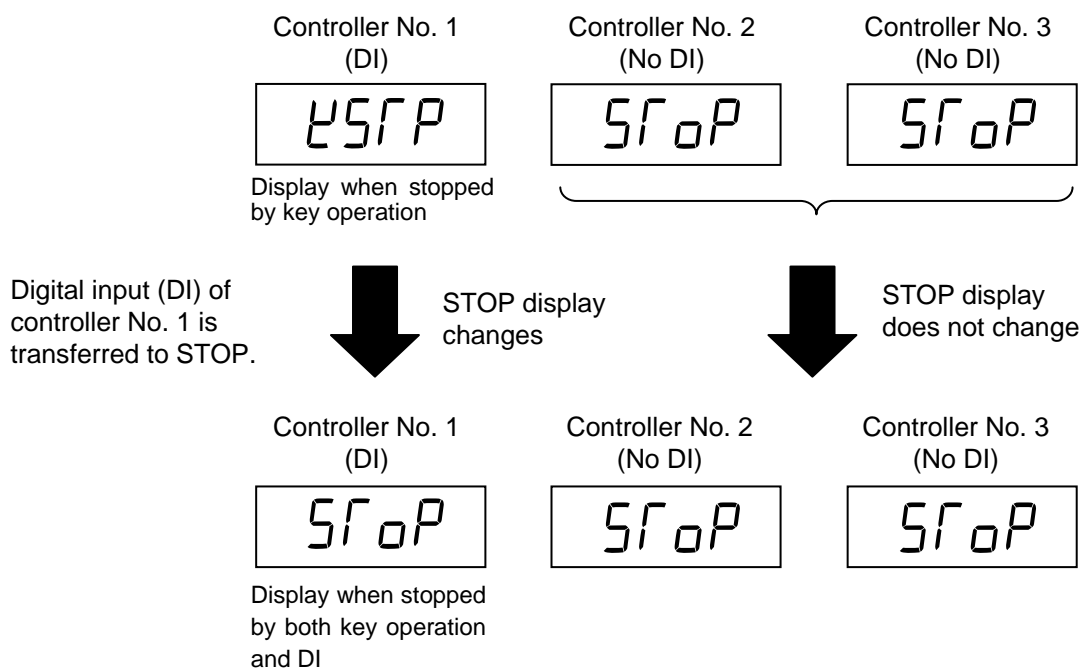

- To transfer from this state to the RUN state, the following operations are necessary.
 - The Digital input (DI) of controller No. 1 is transferred to the RUN state. (Contact open → Contact closed)
 - Any one of controller No.1 to 3 is set to the RUN state by key operation.

6.14.4 Automatic temperature rise function (with learning function)

The Automatic temperature rise function makes multiple controllers one group and synchronizes the temperature rise of the other controllers with the temperature rise of the controller in the same group which takes the longest time for the Measured value (PV) to reach the Set value (SV).

By using the Automatic temperature rise function to balance the temperature rise, uniform temperature control without any local burning or partial thermal expansion of the controlled system is possible.

Also, if started by turning on the Automatic temperature rise learning function (P. 6-78), the data needed by automatic temperature rise can be automatically computed and automatic temperature rise is possible from the next starting.



Since Intercontroller communication has a time lag (maximum 70 ms × number of controllers connected) in data transmission, when using it in a fast response control system, take this time lag into consideration.



The Automatic temperature rise function by Intercontroller communication can be executed when the Communication 2 port (COM2) is usable.



The maximum number of connectable controllers at Intercontroller communication is 32, without regard to the number of groups.



When the group RUN/STOP function is used at automatic temperature rise by Intercontroller communication, all the controllers in the group can start temperature rise simultaneously.

Example: Multipoint temperature control using 4 controllers

- When controller No. 1 to 4 are started without Automatic temperature rise function, the Measured values (PV) individually rise toward the respective Set value (SV1 to 4). As a result, the temperature rise complete timings are also different.
- When controller No. 1 to 4 are made the same group, when the controllers are started using the Automatic temperature rise function after Automatic temperature rise teaching was executed, the temperature rise of controller No. 1 to 3 (slave) is synchronized to the temperature rise of controller No. 4 (master) which takes the longest time of any controller in the group for the Measured value (PV) to reach the Set value (SV). As a result, controller No. 1 to 4 complete temperature rise simultaneously.

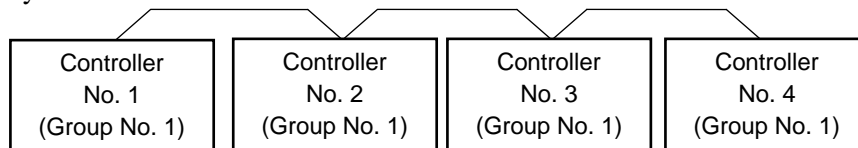

Connection status of the Intercontroller communication

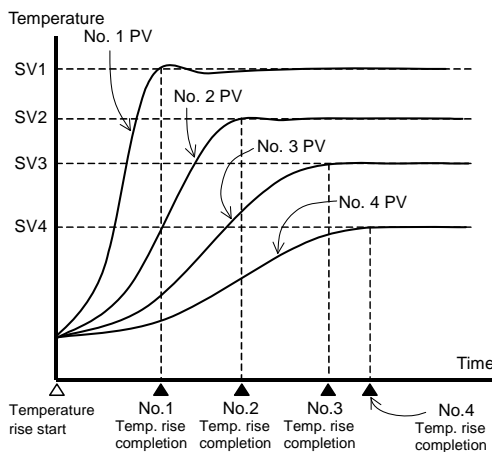

When automatic temperature rise not executed

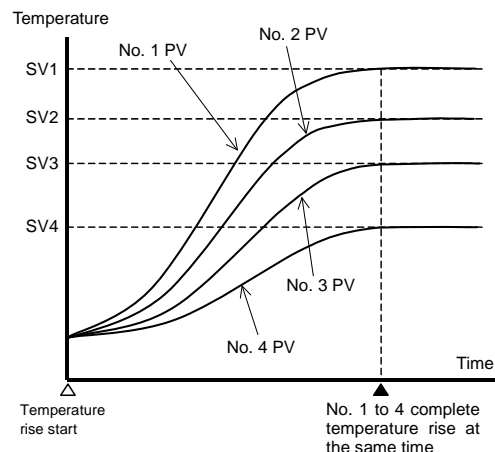

When automatic temperature rise executed

■ Requirements for Automatic temperature rise learning start

Automatic temperature rise learning can be executed when all the following conditions are satisfied.

Operation mode state	RUN/STOP transfer	RUN
	PID/AT transfer	PID control
	Auto/Manual transfer	Auto mode
	Remote/Local transfer	Local mode
Parameter setting	Automatic temperature rise group	Other than 0
	Automatic temperature rise learning	on (Learning)
	Output limiter value	Output limiter high ≥ 0.1 %, Output limiter low ≤ 99.9 %
Input value state	The Measured value (PV) is not underscale or over-scale.	
	Input error determination point (high) \geq Measured value (PV) \geq Input error determination point (low)	
	The Measured value (PV) is stable.	
	Set value (SV) $>$ Measured value (PV) [Heat/Cool PID control]	
Output value state	At startup, output is changed and saturated at the Output limiter high or the Output limiter low. *	

* When the Setting change rate limiter is enabled, there is a concern that the output state when Automatic temperature rise learning is started will not saturate to the output limiter. In this case, the start condition for Automatic temperature rise learning cannot be met.



When starting Automatic temperature rise learning, start with a temperature difference between the Measured value (PV) and Set value (SV) of more than twice the proportional band.

■ Requirements for Automatic temperature rise learning cancellation

If any of the following states occur, Automatic temperature rise learning is immediately stopped. In this case, Automatic temperature rise learning remains set to “on (Learning).”

When the parameter is changed	The Automatic temperature rise learning setting is changed to “oFF (Unused).”
	When the PV bias, the PV digital filter, or the PV ratio is changed.
When the Operation mode is transferred	When the RUN/STOP mode is changed to the STOP mode.
	When the Auto/Manual mode is changed to the Manual mode.
	When the Remote/Local mode is changed to the Remote mode.
When the input value becomes abnormal	When the Measured value (PV) goes to underscale or over-scale.
	When the Measured value (PV) goes to input error range. (Measured value (PV) \geq Input error determination point (high) or Input error determination point (low) Measured value (PV))
The execution time for Automatic temperature rise learning is exceeded.	Automatic temperature rise learning does not end after approximately 100 minutes has elapsed following the start of Automatic temperature rise learning.
Power failure	When the power failure of more than 20 ms occurs.
Instrument error	When the instrument is in the FAIL state.

■ Requirements for Automatic temperature rise start

When all the controllers in a group satisfy the following conditions, Automatic temperature rise is executed.

Operation mode state	RUN/STOP transfer	RUN ¹
	PID/AT transfer	PID control
	Auto/Manual transfer	Auto mode
Parameter setting	Control action	PID control (reverse action or direct action) Heat/Cool PID control (air cooling, water cooling, cooling gain linear type) ²
	Automatic temperature rise group	Other than 0
	Automatic temperature rise learning	oFF (Unused)
Input value state		The Measured value (PV) is not underscale or over-scale.
		No burn out (input break or short circuit)
		Input error determination point (high) \geq Measured value (PV) \geq Input error determination point (low)
		Reverse action and Heat/Cool PID control (air cooling, water cooling, cooling gain linear type) ² : Set value (SV) $>$ Measured value (PV) at start of automatic temperature rise Direct action: Set value (SV) $<$ Measured value (PV) at start of automatic temperature rise

¹ [RUN] (in RUN/STOP transfer) is absolute requirements for automatic temperature rise. The automatic temperature rise function is suspended if any one controller in the group does not satisfy this requirement. As soon as this requirement is satisfied, the automatic temperature rise is started.

If condition other than [RUN] is not satisfied, the controller where the condition is not matched is disabled for the automatic temperature rise, and the automatic temperature rise is executed in other controllers.

² When in Heat/Cool PID control, an automatic temperature rise only in the temperature rise direction is enabled.



Automatic temperature rise and Startup tuning (ST) can be executed simultaneously.

■ Requirements for Automatic temperature rise cancellation

When an abort condition is established for the master:

Automatic temperature rise of all the controllers in the group immediately stops and switches to normal control.

When an abort condition is established for the slaves:

The automatic temperature rise is aborted at the controller where the abort condition is established and normal control is started. Other controllers continue the automatic temperature rise.



When the automatic temperature rise is started, the controller which takes the longest time for the Measured value (PV) to reach the Set value (SV) of all the controllers in the group automatically becomes the master.

Operation mode state	RUN/STOP transfer	When the RUN/STOP mode is changed to the STOP mode.
	PID/AT transfer	When the Autotuning (AT) is activated.
	Auto/Manual transfer	When the Auto/Manual mode is changed to the Manual mode.
Parameter setting		When the proportional band is set to 0. (When the control type is changed to ON/OFF control)
Input value state		When the Measured value (PV) goes to underscale or over-scale.
		When the burnout occurs (input break or short circuit)
		When the Measured value (PV) goes to input error range. (Measured value (PV) \geq Input error determination point (high) or Input error determination point (low) \geq Measured value (PV))
Communication		When an Intercontroller communication error is generated.
Power failure		When the power failure of more than 20 ms occurs.
Instrument error		When the instrument is in the FAIL state.

■ Operation flowchart

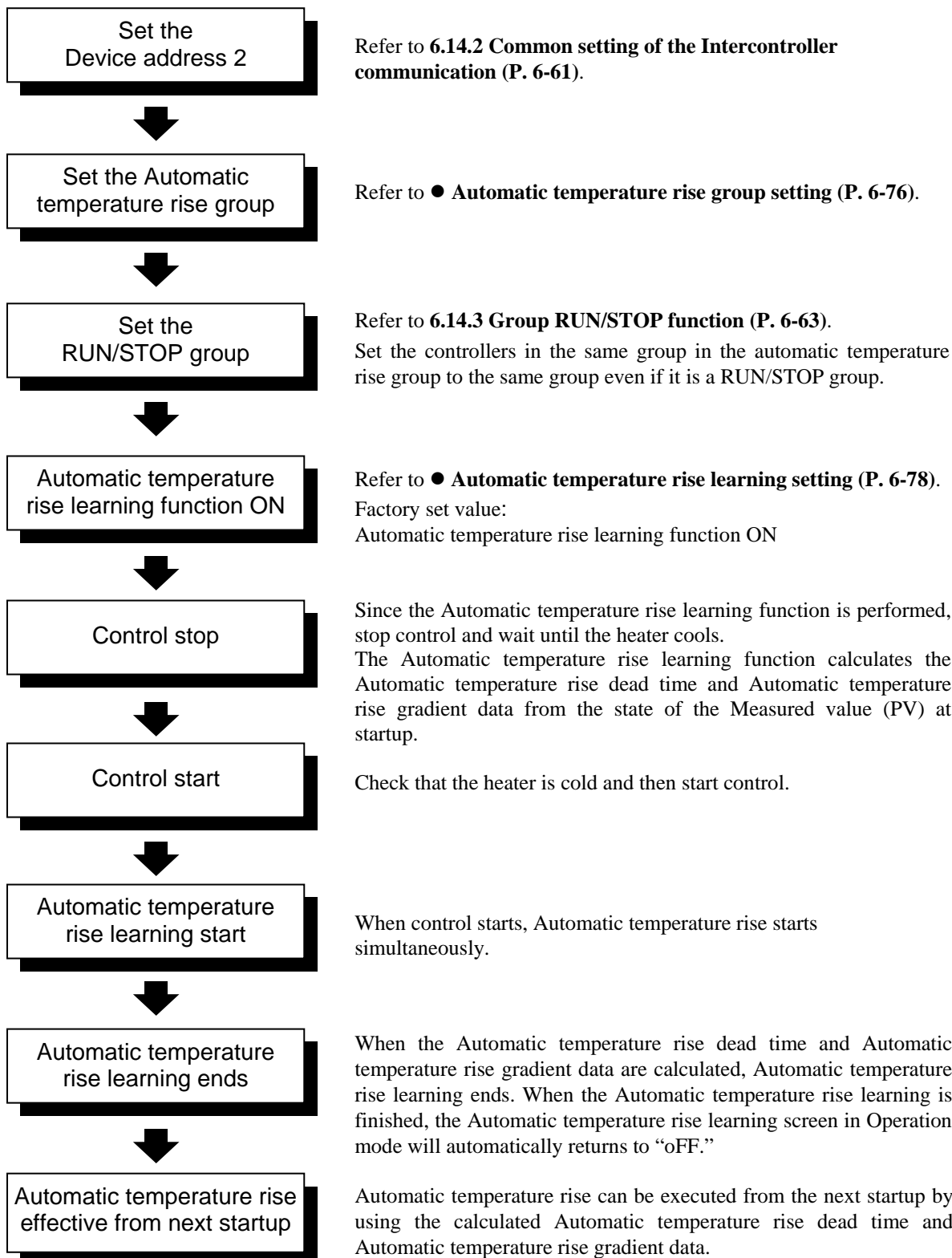

When in Heat/Cool PID control, Automatic temperature rise learning and Automatic temperature rise are only in the temperature rise direction.

■ Settings before operation

When implementing the Automatic temperature rise function, the following items must be set.

- Device address 2 [Setup setting mode]
 - Automatic temperature rise group [Engineering mode: Function block 55]
 - RUN/STOP group [Engineering mode: Function block 55]
 - Automatic temperature rise learning [Operation mode]
- ☞ For the Device address 2 setting, refer to **6.14.2 Common setting of the Intercontroller communication (P. 6-61)**.
- ☞ For the RUN/STOP group setting, refer to **6.14.3 Group RUN/STOP function (P. 6-63)**.

● Automatic temperature rise group setting

Set the number of the group which performs Automatic temperature rise for each controller.

1. Change the operation mode from RUN mode to STOP mode.

☞ To change from RUN mode to STOP mode, refer to **6.4 RUN/STOP Transfer (P. 6-11)**.

2. Press the Shift key while pressing the SET key for 2 seconds at PV/SV monitor screen until Engineering mode is displayed. Function block 10 screen is displayed first.

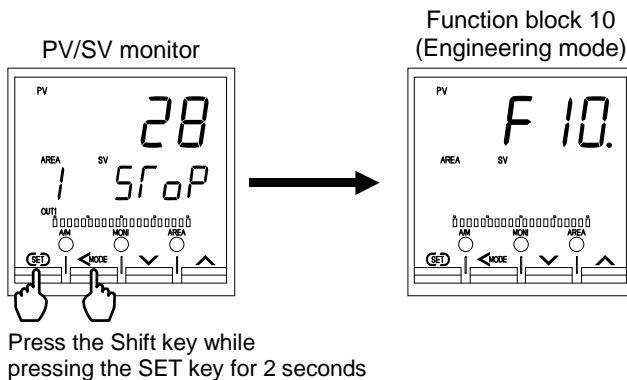

3. Press the UP key or DOWN key until Function block 55 screen is displayed.

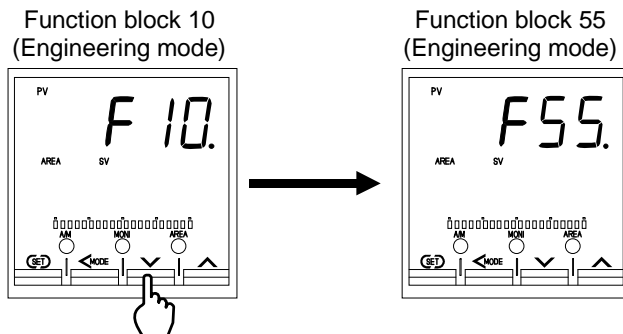

- Press the SET key until Automatic temperature rise group screen is displayed.

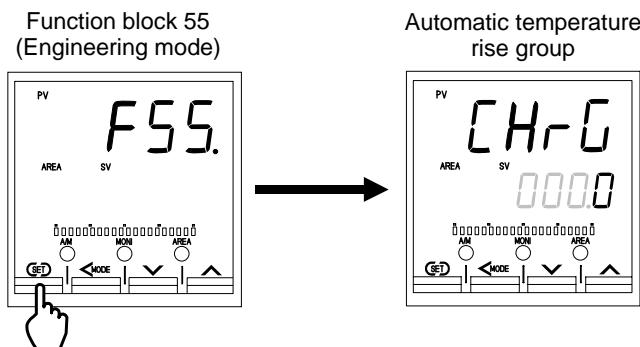

- Select the Automatic temperature rise group number which needs to be changed by pressing the UP or DOWN key.

Setting range: 0 to 16 (Factory set value: 0)

Automatic temperature rise group

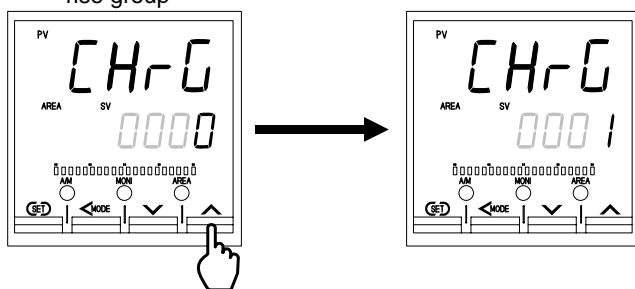

Set the controllers in the same group in the Automatic temperature rise group to the same group even if it is a RUN/STOP group.



When the group number is set to “0,” that controller does not perform Automatic temperature rise.



After a new value is displayed on the display by using UP and DOWN keys, if no key operation is performed within 1 minute without pressing SET key, this instrument returns to the PV/SV monitor screen and the Automatic temperature rise group number will not be changed.

- Press the SET key to store the new Automatic temperature rise group number. The screen goes to the next parameter.

Automatic temperature rise group

RUN/STOP group

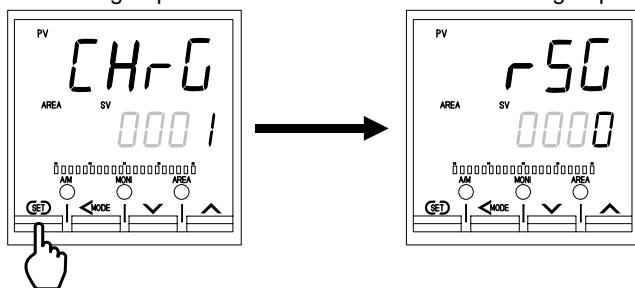

RUN/STOP group setting is possible in this state. For details, refer to **6.14.3 Group RUN/STOP function (P. 6-63)**.

- To return the PV/SV monitor, press the MONI key (for Direct key Type 1), or press the Shift key while pressing the SET key.
- Set the Automatic temperature rise group number of the other controllers by the same procedures as described in steps 1 to 7 above.

● **Automatic temperature rise learning setting**

Set the Automatic temperature rise leaning function ON/OFF for each controller.

1. Press and hold the SET key for 2 seconds at PV/SV monitor screen until Operation mode is displayed.
PID/AT transfer screen is displayed first.

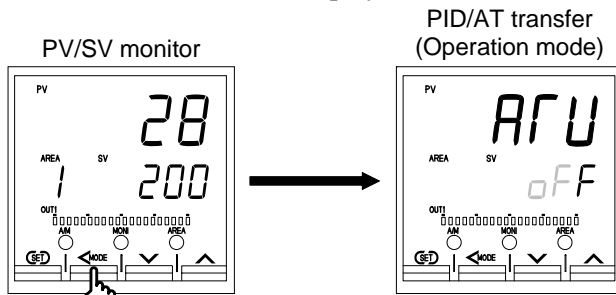

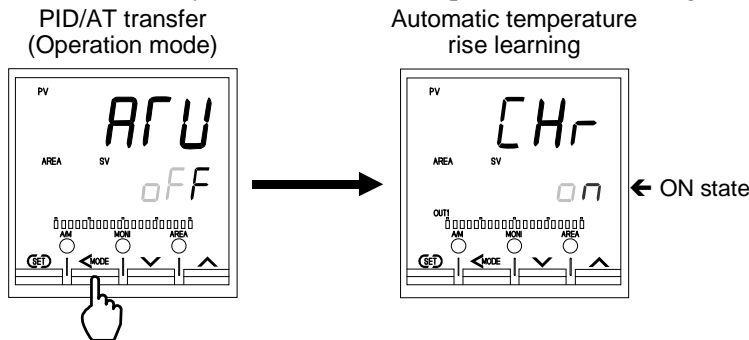

Press and hold the Shift key for 2 seconds

2. Press the Shift key until Automatic temperature rise learning screen is displayed.

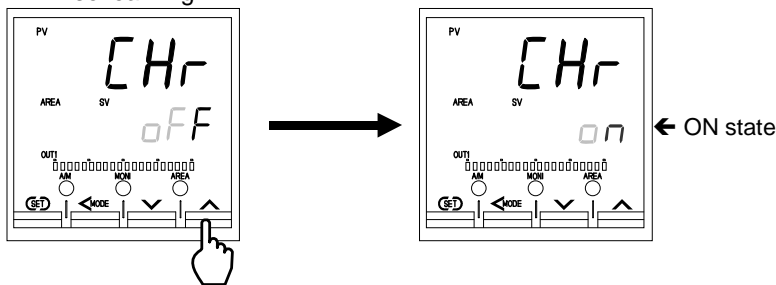

3. When the UP key is pressed, it switches from “oFF” to “on.” In addition, since the shipping value is “on,” when executing Automatic temperature rise leaning, it can be used as is.
Automatic temperature rise learning



 Press the DOWN key to change to “oFF” from “on.”

 After a new value is displayed on the display by using UP and DOWN keys, if no key operation is performed within 1 minute without pressing SET key, this instrument returns to the PV/SV monitor screen and the Automatic temperature rise leaning ON/OFF will not be changed.

4. Press the Shift key or the SET key to store the new Automatic temperature rise learning ON/OFF data. The screen goes to the next parameter.

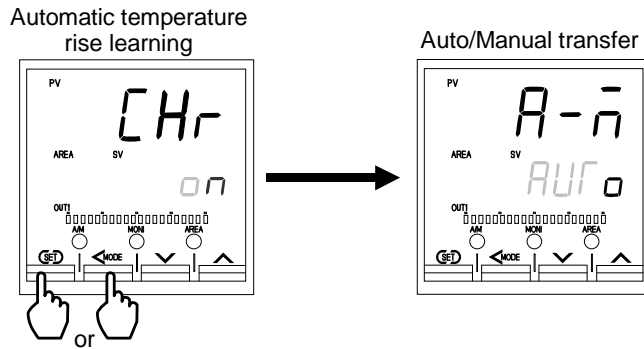

5. To return the PV/SV monitor, press the MONI key (for Direct key Type 1), or press the Shift key while pressing the SET key.
6. Set the Automatic temperature rise learning of the other controllers by the same procedures as described in steps 1 to 5 above.

■ Operation procedures

● When using the learning function

When using the learning function, the data (Automatic temperature rise dead time, Automatic temperature rise gradient data, etc.) necessary at Automatic temperature rise is automatically computed. Learning is implemented at controller startup.

1. Set the Device address 2 for each controller.

 For the Device address 2 setting, refer to **6.14.2 Common setting of the Intercontroller communication (P. 6-61)**.

2. Set the Automatic temperature rise group number for each controller and set the Automatic temperature rise function to ON in advance. In addition, set the RUN/STOP group for performing the group RUN/STOP function. Set the controllers in the same group in the Automatic temperature rise group to the same group even if it is a RUN/STOP group.

 For the Automatic temperature rise group number and Automatic temperature rise learning function setting, refer to **■ Settings before operation (P. 6-76)**.

 For the RUN/STOP group setting, refer to **6.14.3 Group RUN/STOP function (P. 6-63)**.

3. Set control to the STOP state, and wait until the heater cools.

Since the Automatic temperature rise learning function computes the Automatic temperature rise dead time and Automatic temperature rise gradient data from the state of the Measured value (PV) at startup, the heater must be placed in the cold state once.

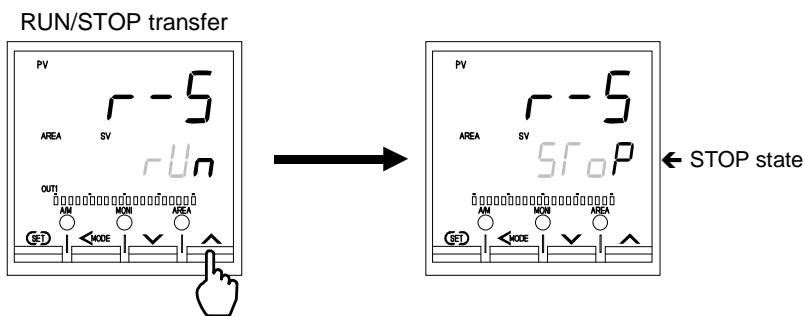

 For the RUN/STOP transfer, refer to **6.4 RUN/STOP Transfer (P. 6-11)**.

For the group RUN/STOP, refer to **6.14.3 Group RUN/STOP function (P. 6-63)**.

4. When control is set to the RUN state after it is confirmed that the heater is cold, Automatic temperature rise learning is started.

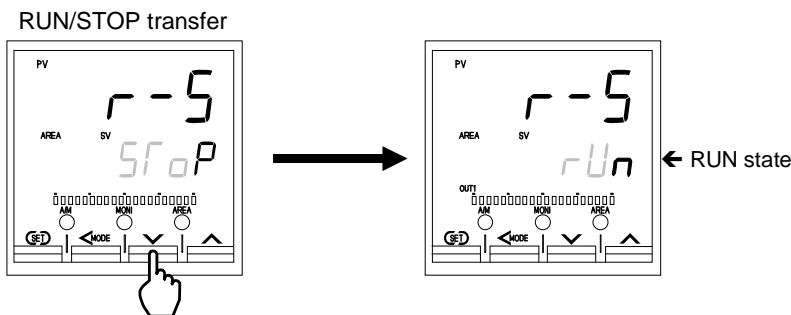



 For the RUN/STOP transfer, refer to **6.4 RUN/STOP Transfer (P. 6-11)**.

For the group RUN/STOP, refer to **6.14.3 Group RUN/STOP function (P. 6-63)**.

5. When the Automatic temperature rise dead time and Automatic temperature rise gradient data are computed, Automatic temperature rise learning ends.

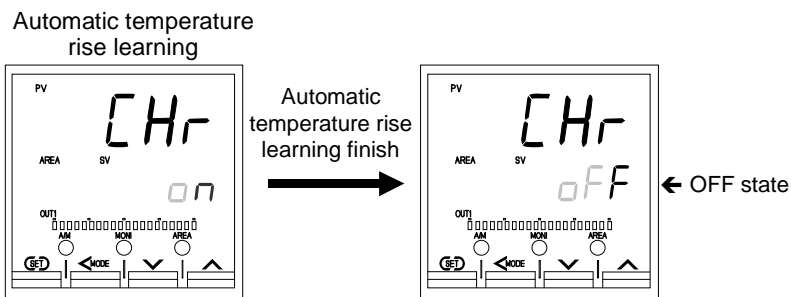
When the Automatic temperature rise learning is finished, the Automatic temperature rise learning screen in Operation mode will automatically returns to “oFF.”



 **At this point, the data necessary at Automatic temperature rise is only collected. Automatic temperature rise is not yet executed. Automatic temperature rise can be executed from the next startup.**

 When the Automatic temperature rise group and other set values were changed, execute Automatic temperature rise learning again.

 Automatic temperature rise learning can be performed for each controller. It can also be performed by group batch by using the group RUN/STOP function.

 When Automatic temperature rise learning is not established, the operation mode Automatic temperature rise learning screen remains “on.”

● **When performing Automatic temperature rise (when ending the learning function)**

1. When the controllers of the Automatic temperature rise group are set to RUN simultaneously, Automatic temperature rise starts. Automatic temperature rise is executed by controllers other than Automatic temperature rise group number “0.”

 To RUN the controllers of the Automatic temperature rise group simultaneously, use the group RUN/STOP function. For the group RUN/STOP, refer to **6.14.3 Group RUN/STOP function (P. 6-63)**.

2. The other controllers perform temperature rise in synchronization with the temperature rise of the controller which takes the longest for the Measured value (PV) to reach the Set value (SV) in the same group. The controllers in the same group complete temperature rise simultaneously.

 When you do not want to execute Automatic temperature rise, set the Automatic temperature rise group number of the relevant controller to “0.”

6.14.5 Cascade control function

Cascade control monitors the controlled object temperature in the master unit and then corrects the set value in the slave unit depending on the deviation between the target value (set value) and actual temperature. The slave unit controls the non-controlled object (heater, refrigeration device, etc). As a result, the controlled object temperature can be reached and controlled at the target value.

At Cascade control that uses Intercontroller communication, one of the connected controllers is specified the master and the other arbitrary controllers are controlled as slaves.

 **Since Intercontroller communication has a time lag (maximum 70 ms × number of controllers connected) in data transmission, when using it in a fast response control system, take this time lag into consideration.**
[The Slave set value (remote SV) is updated at each time lag.]

 The Cascade control by Intercontroller communication can be executed when the Communication 2 port (COM2) is usable. In addition, Cascade control slave controllers cannot use remote setting input.

 The maximum number of combined master and slave controllers connectable at Intercontroller communication is 32.

Example: When using 3 controllers and controlling extruders in cascade

Specify one controller as the master and use the remaining two controllers as slaves. The master Manipulated output value (MV) becomes the slave Set value (SV).

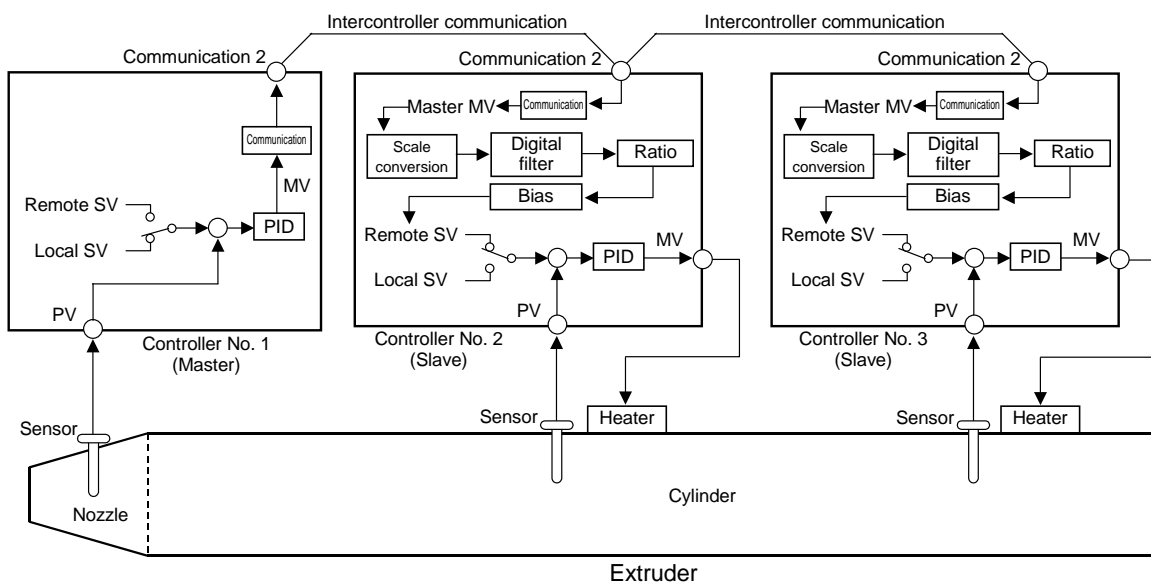
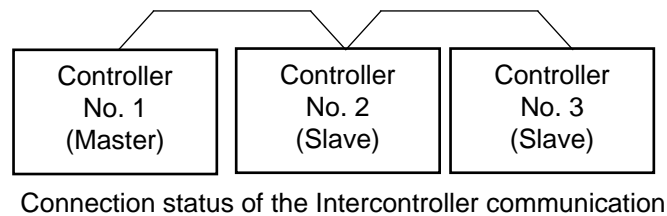

Block diagram of Cascade control by Intercontroller communication

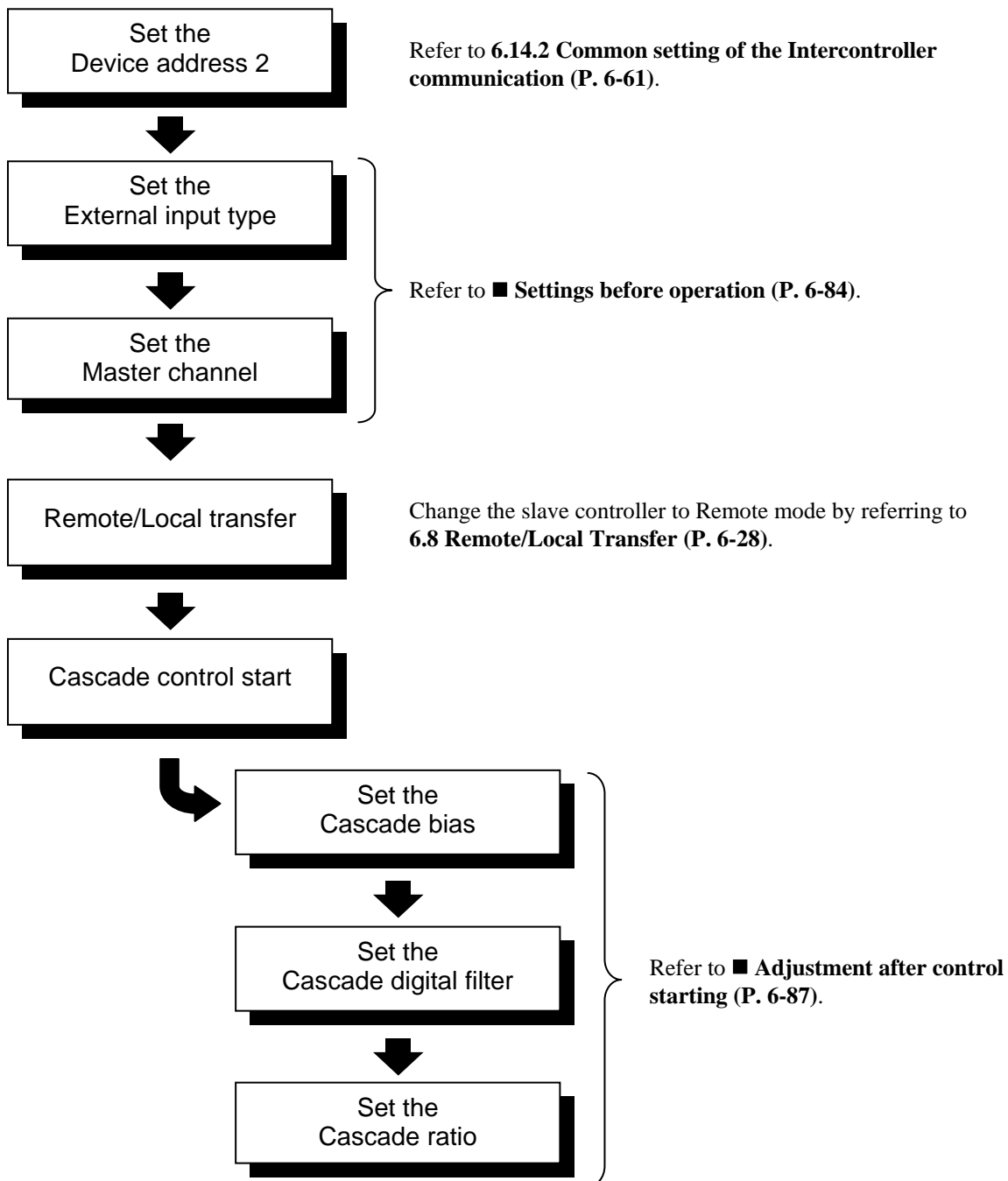
■ Operation flowchart

■ Settings before operation

When implementing the cascade control, the following items must be set.

- Device address 2 [Setup setting mode]
- External input type [Engineering mode: Function block 50]
- Master channel selection [Engineering mode: Function block 50]

☞ For the Device address 2 setting, refer to **6.14.2 Common setting of the intercontroller communication (P. 6-61)**.

● Set the External input type and Master channel selection

Set the External input type for each controller. In addition, select the controller which is to become the Cascade control master.

1. Change the operation mode from RUN mode to STOP mode.

☞ To change from RUN mode to STOP mode, refer to **6.4 RUN/STOP Transfer (P. 6-11)**.

2. Press the Shift key while pressing the SET key for 2 seconds at PV/SV monitor screen until Engineering mode is displayed. Function block 10 screen is displayed first.

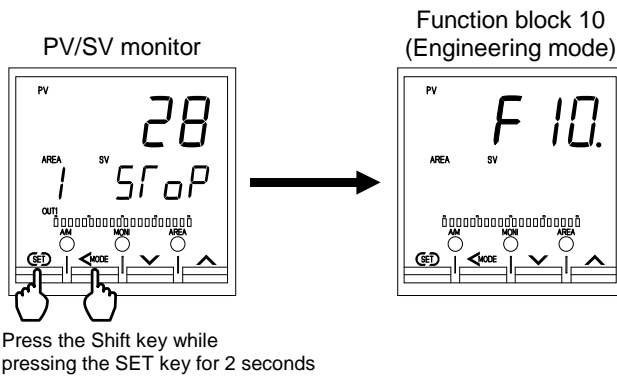

3. Press the UP key or DOWN key until Function block 50 screen is displayed.

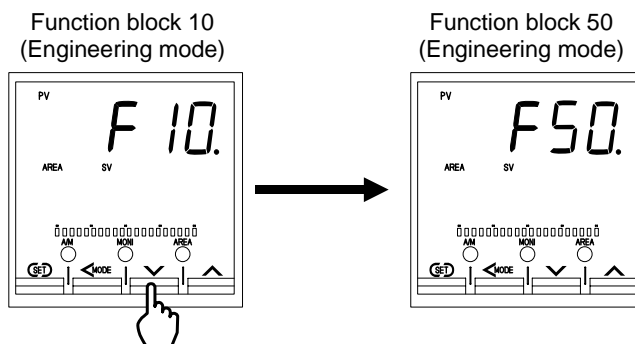

4. Press the SET key until External input type setting screen is displayed.

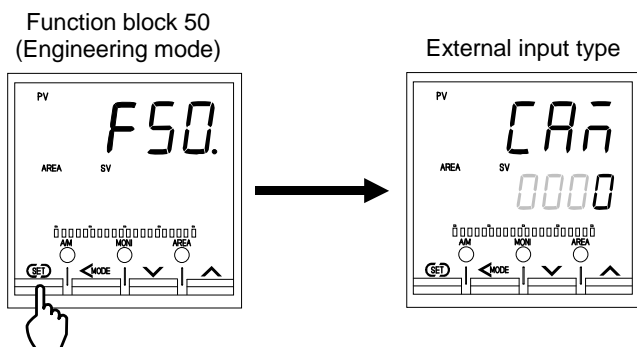

5. Select the External input type which needs to be changed by pressing the UP or DOWN key.
Set "0" to the master controller and "1" to the slave controller.

Setting range: 0: Remote setting (RS) input

1: Intercontroller communication cascade control

2: Intercontroller communication ratio setting

(Factory set value: 0)

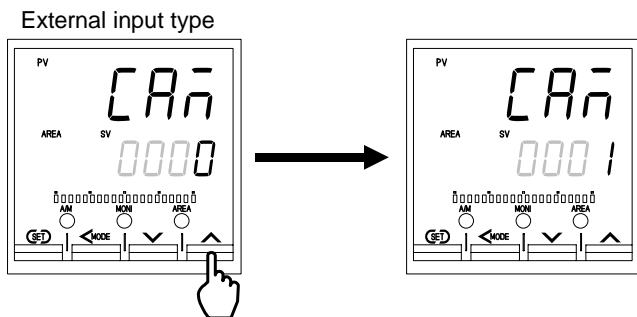

After a new value is displayed on the display by using UP and DOWN keys, if no key operation is performed within 1 minute without pressing SET key, this instrument returns to the PV/SV monitor screen and the External input type will not be changed.

6. Press the SET key to store the new External input type. The screen goes to the Master channel selection screen.

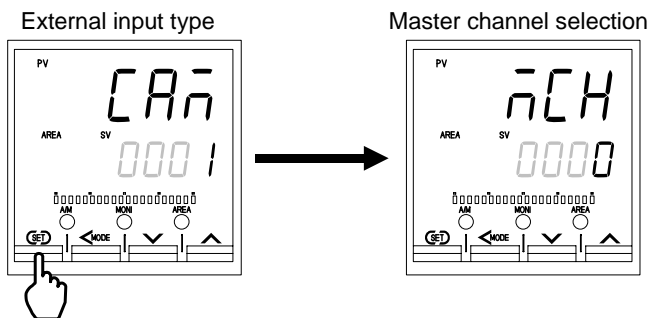

- Press the UP key or DOWN key and set the address (value set by the Device address 2 screen) of the controller specified the cascade control master. Set the Master channel to only the slave controller. No setting of the master controller is required.

Setting range: 0 to 31 (Factory set value: 0)

Master channel selection

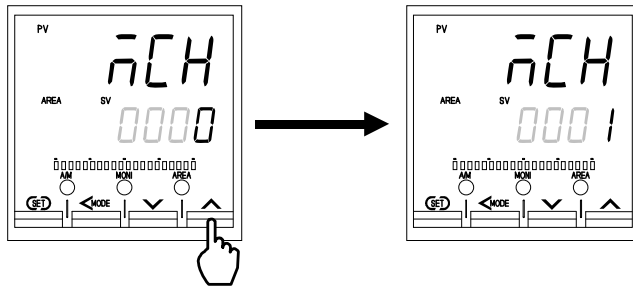

After a new value is displayed on the display by using UP and DOWN keys, if no key operation is performed within 1 minute without pressing SET key, this instrument returns to the PV/SV monitor screen and the Master channel will not be changed.

- Press the SET key to store the new Master channel. The screen goes to the next parameter.

Master channel selection

SV tracking

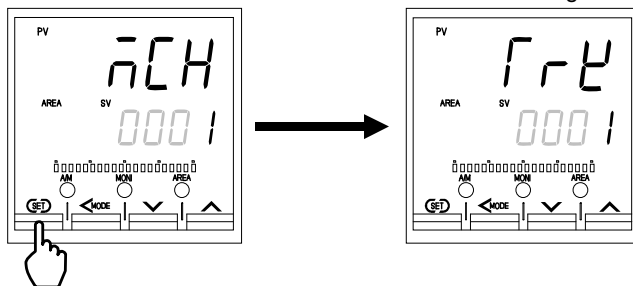

- To return the PV/SV monitor, press the MONI key (for Direct key Type 1), or press the Shift key while pressing the SET key.

- Set the External input type and Master channel selection of the other controllers by the same procedures as described in steps 1 to 9 above.

■ Adjustment after control starting

● Set the Cascade bias, Cascade digital filter and Cascade ratio

Set the bias, digital filter, and ratio at each controller for the setting input (master MV) from the master. Set these according to the actual operation state.

 When the controller selected as the master was placed into the Remote mode, the RS bias, RS digital filter, and RS ratio can be set.

 The relationship between master MV and slave SV by slave Cascade ratio and Cascade bias is shown by the example below.

Example: When the output scale of master is 0 to 100 % and the input scale of slave is -100 to $+400$ °C

- Cascade ratio (slave): 1.000, Cascade bias (slave): 0 °C
Slave input scale for master output scale 0 to 100 % is -100 to $+400$ °C
- Cascade ratio (slave): 0.500, Cascade bias (slave): 100 °C
Slave input scale for master output scale 0 to 100 % is 50 to 300 °C

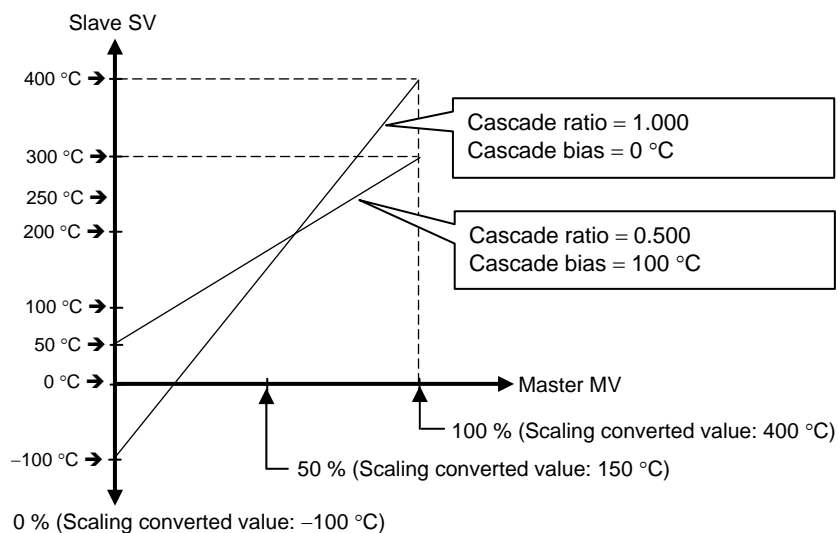

1. Press the Shift key while pressing the SET key at PV/SV monitor screen until Setup setting mode is displayed. The screen displayed first differs depending on the specification.

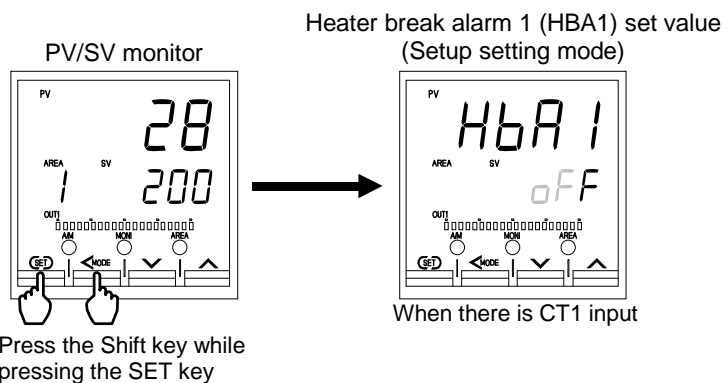

2. Press the SET key until Cascade bias screen is displayed.

Press the Shift key, UP key, or DOWN key and set the bias for the setting input (master MV) from the master.

Setting range: –Input span to +Input span (Factory set value: 0)

Cascade bias
(RS bias)

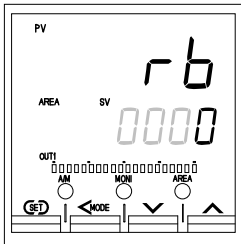

If the External input type is Remote setting input, the Cascade bias screen becomes the RS bias screen and if Intercontroller communication ratio setting, it becomes the Ratio setting bias screen. In other places, this is indicated as “RS bias.”



After a new value is displayed on the display by using UP and DOWN keys, if no key operation is performed within 1 minute without pressing SET key, this instrument returns to the PV/SV monitor screen and the Cascade bias will not be changed.

3. Press the SET key to store the new Cascade bias. The screen goes to the Cascade digital filter screen. Press the Shift key, UP key, or DOWN key and set the digital filter for the setting input (master MV) from the master.

Setting range: 0.1 to 100.0 seconds

oFF: Unused (Factory set value: oFF)

Cascade digital filter
(RS digital filter)

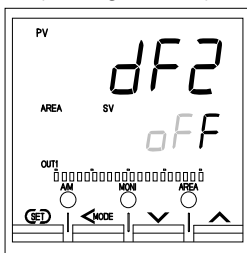

If the External input type is Remote setting input, the Cascade digital filter screen becomes the RS digital filter screen and if Intercontroller communication ratio setting, it becomes the Ratio setting digital filter screen. In other places, this is indicated as “RS digital filter.”



After a new value is displayed on the display by using UP and DOWN keys, if no key operation is performed within 1 minute without pressing SET key, this instrument returns to the PV/SV monitor screen and the Cascade digital filter will not be changed.

- Press the SET key to store the new Cascade digital filter. The screen goes to the Cascade ratio screen. Press the Shift key, UP key, or DOWN key and set the ratio for the setting input (master MV) from the master.

Setting range: 0.001 to 9.999 (Factory set value: 1.000)

Cascade ratio
(RS ratio)

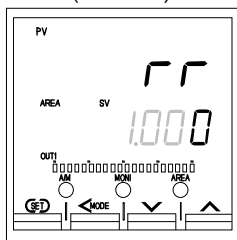

If the External input type is Remote setting input, the Cascade ratio screen becomes the RS ratio screen and if Intercontroller communication ratio setting, it becomes the Ratio setting ratio screen. In other places, this is indicated as “RS ratio.”



After a new value is displayed on the display by using UP and DOWN keys, if no key operation is performed within 1 minute without pressing SET key, this instrument returns to the PV/SV monitor screen and the Cascade ratio will not be changed.

- Press the SET key to store the new Cascade ratio. The screen goes to the next parameter.

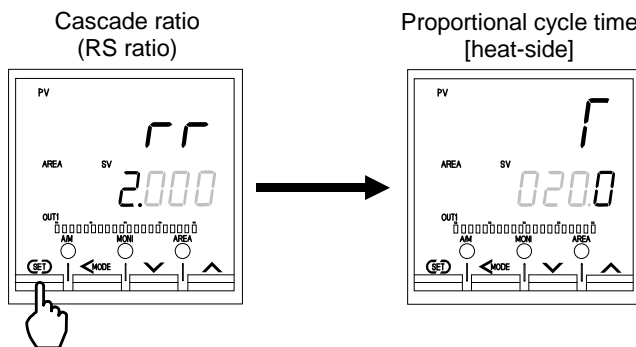

- To return the PV/SV monitor, press the MONI key (for direct key type 1), or press the Shift key while pressing the SET key.
- Set the Cascade bias, Cascade digital filter and Cascade ratio of the other slaves by the same procedures as described in steps 1 to 6 above.



For the setting procedure, refer to **5.2.2 Changing and registering of the setting item (P. 5-8)** or **6.3 Operating Setting (P. 6-5)**.

■ Operation procedures

1. Set the Device address 2 for each controller.

 For the Device address 2 setting, refer to **6.14.2 Common setting of the Intercontroller communication (P. 6-61)**.

2. Set the External input type for each controller.

Set “0: Remote setting (RS) input” to the master controller, and “1: Intercontroller communication cascade control” to the slave controller.

 For the External input type setting, refer to **■ Settings before operation (P. 6-84)**.

3. Set the master for the Cascade control.

Set the address (setting of the Device address 2) of the controller which becomes the master at the controllers which become the slaves. Setting is unnecessary for the master.

 For the Master channel setting, refer to **■ Settings before operation (P. 6-84)**.

4. Change the slave controller to Remote mode. Cascade control by Intercontroller communication can be executed if the slave controllers are in the Remote mode.

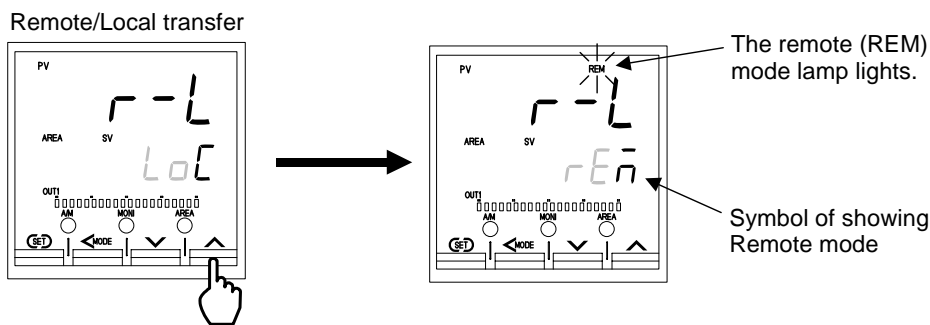

 To change from the Local mode to the Remote mode, refer to **6.8 Remote/Local Transfer (P. 6-28)**.

5. The settings above starts Cascade control by Intercontroller communication.

6. Perform Cascade bias, Cascade digital filter, and Cascade ratio adjustment which actually operating.

 For the Cascade bias, Cascade digital filter, and Cascade ratio, refers to **■ Adjustment after control starting (P. 6-87)**.

6.14.6 Ratio setting function

Ratio setting exercises control with the product of the Set value (SV) from the master multiplied by a fixed ratio as the slave Set value (SV).

 Since Intercontroller communication has a time lag (maximum 70 ms × number of controllers connected) in data transmission, when using it in a fast response control system, take this time lag into consideration.

[The slave Set value (remote SV) is updated at each time lag.]

 The Ratio setting by Intercontroller communication can be executed when the Communication 2 port (COM2) is usable. In addition, Ratio setting slave controllers cannot use Remote setting input.

 The maximum number of combined master and slave controllers connectable at Intercontroller communication is 32.

Example: When using 3 controllers and setting extruders in ratio

Specify one controller as the master and use the remaining two controllers as slaves. The product of the master Set value (SV) multiplied by a fixed ratio becomes the slave Set value (SV).

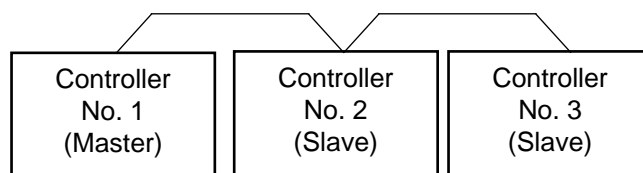

Connection status of the Intercontroller communication

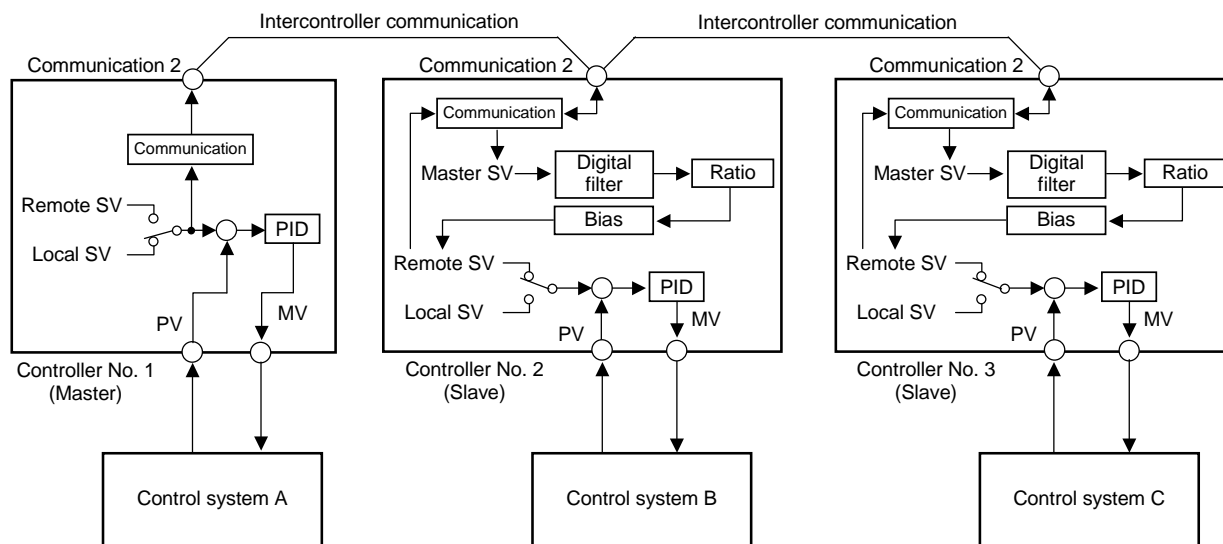

Block diagram of Ratio setting by Intercontroller communication

■ **Operation flowchart**

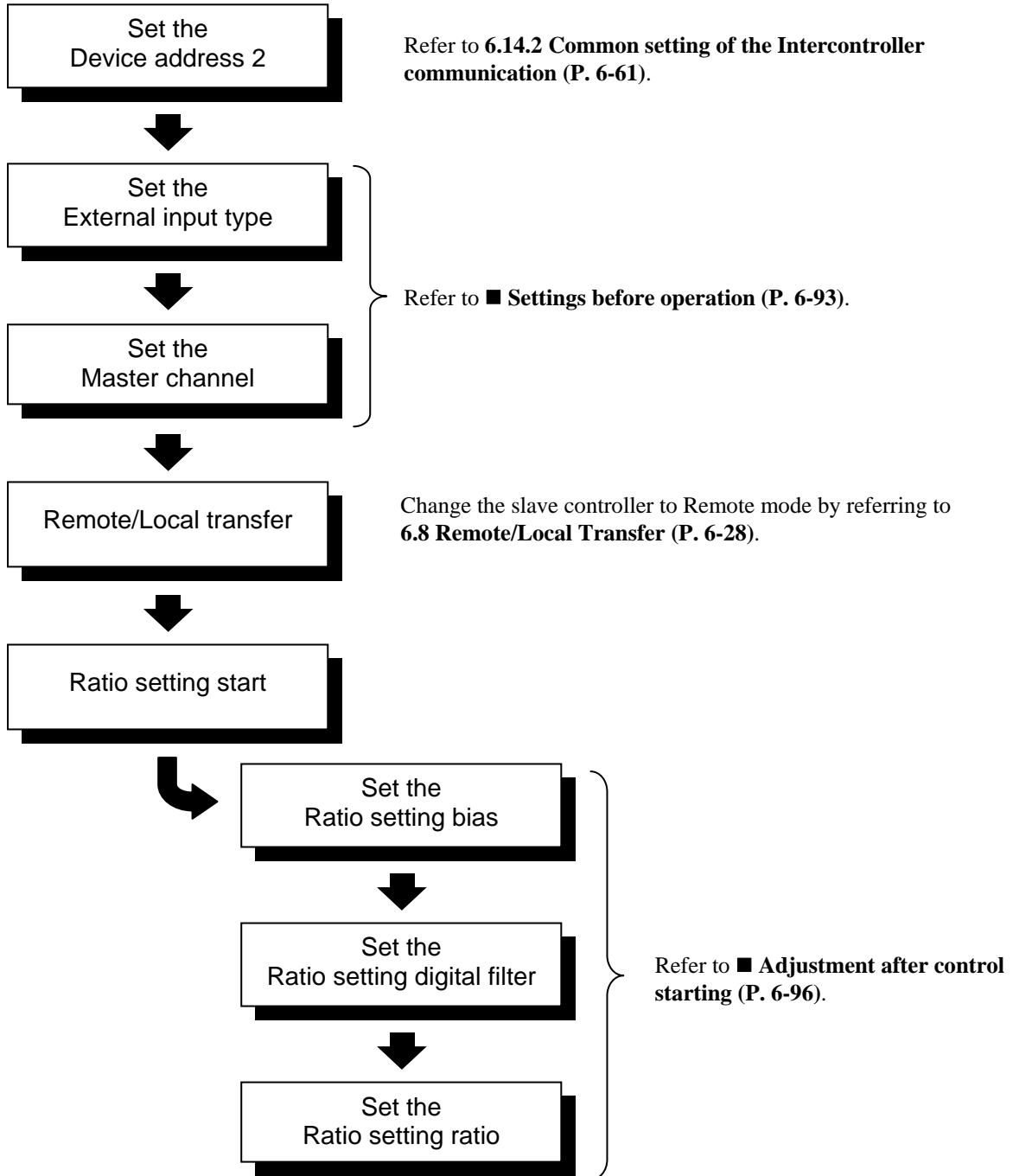

■ Settings before operation

When implementing the Ratio setting, the following items must be set.

- Device address 2 [Setup setting mode]
- External input type [Engineering mode: Function block 50]
- Master channel selection [Engineering mode: Function block 50]

☞ For the Device address 2 setting, refer to **6.14.2 Common setting of the Intercontroller communication (P. 6-61)**.

● Set the External input type and Master channel selection

Set the External input type for each controller. In addition, select the controller which is to become the Ratio setting master.

1. Change the operation mode from RUN mode to STOP mode.

☞ To change from RUN mode to STOP mode, refer to **6.4 RUN/STOP Transfer (P. 6-11)**.

2. Press the Shift key while pressing the SET key for 2 seconds at PV/SV monitor screen until Engineering mode is displayed. Function block 10 screen is displayed first.

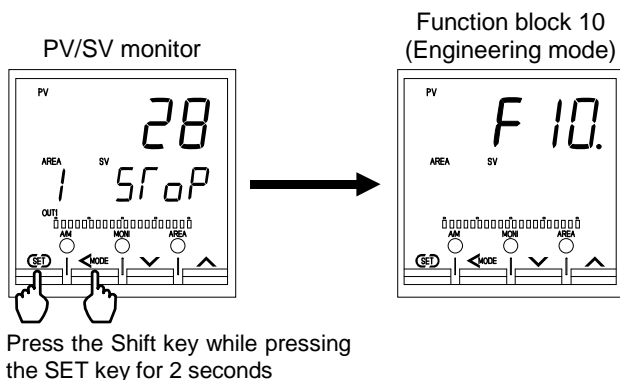

3. Press the UP key or DOWN key until Function block 50 screen is displayed.

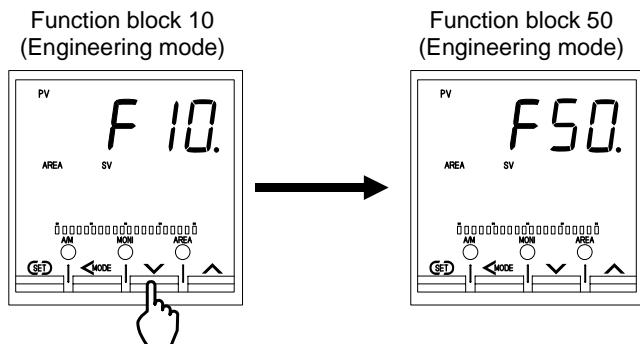

4. Press the SET key until External input type setting screen is displayed.

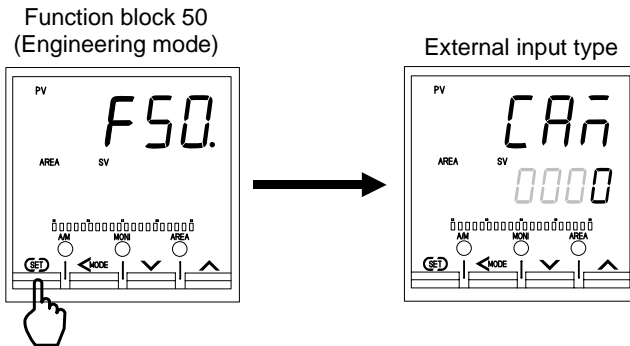

5. Select the External input type which needs to be changed by pressing the UP or DOWN key. Set "0" to the master controller and "2" to the slave controller.

Setting range: 0: Remote setting (RS) input

1: Intercontroller communication cascade control

2: Intercontroller communication ratio setting

(Factory set value: 0)

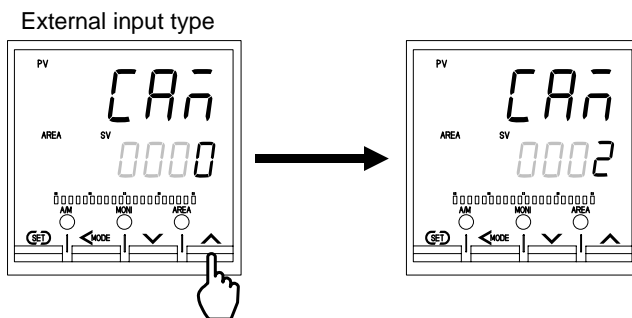

After a new value is displayed on the display by using UP and DOWN keys, if no key operation is performed within 1 minute without pressing SET key, this instrument returns to the PV/SV monitor screen and the External input type will not be changed.

6. Press the SET key to store the new External input type. The screen goes to Master channel selection screen.

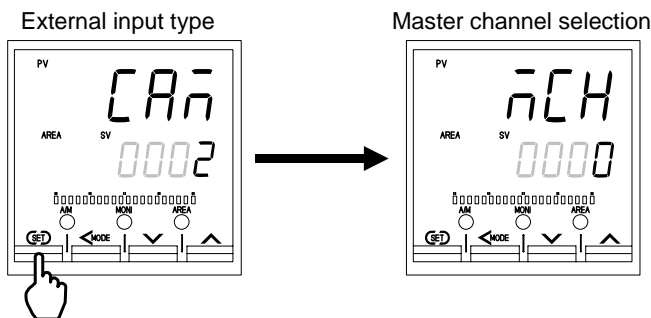

7. Press the UP key or DOWN key and set the address (value set by the Device address 2 screen) of the controller specified the ratio setting master. Set the Master channel to only the slave controller. No setting of the master controller is required.

Setting range: 0 to 31 (Factory set value: 0)

Master channel selection

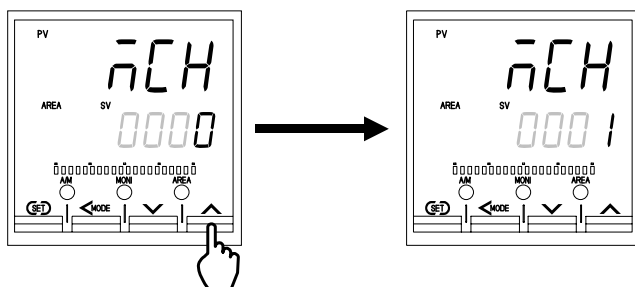

After a new value is displayed on the display by using UP and DOWN keys, if no key operation is performed within 1 minute without pressing SET key, this instrument returns to the PV/SV monitor screen and the Master channel will not be changed.

8. Press the SET key to store the new Master channel. The screen goes to the next parameter.

Master channel selection

SV tracking

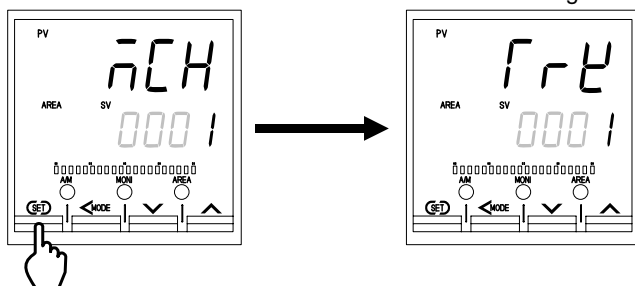

9. To return the PV/SV monitor, press the MONI key (for Direct key Type 1), or press the Shift key while pressing the SET key.

10. Set the External input type and Master channel selection of the other controllers by the same procedures as described in steps 1 to 9 above.

■ **Adjustment after control starting**

● **Set the Ratio setting bias, Ratio setting digital filter and Ratio setting ratio**

Set the bias, digital filter, and ratio at each controller for the setting input (master MV) from the master. Set these according to the actual operation state.

 When the controller selected as the master was placed into the Remote mode, the RS bias, RS digital filter, and RS ratio can be set.

 The relationship between master SV and slave SV by slave Ratio setting ratio and Ratio setting bias is shown by the example below.

Example: When the master and slave setting limiter range is 0 to 400 °C

- Ratio setting ratio (slave): 0.500, Ratio setting bias (slave): 20 °C
Master Set value (SV): 200 °C → Slave Set value (SV): 120 °C

- Ratio setting ratio (slave): 2.000, Ratio setting bias (slave): 100 °C
Master Set value (SV): 200 °C → Slave Set value (SV): 400 °C *

* According to the computed value, the slave Set value (SV) becomes 500 °C but since the Setting limiter range is 0 to 400 °C, the slave Set value (SV) becomes the Setting limiter high limit value: 400 °C

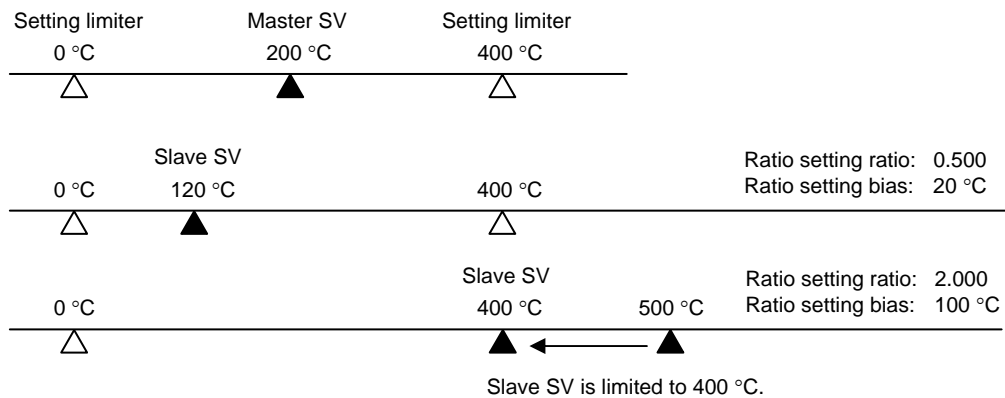

1. Press the Shift key while pressing the SET key at PV/SV monitor screen until Setup setting mode is displayed. The screen displayed first differs depending on the specification.

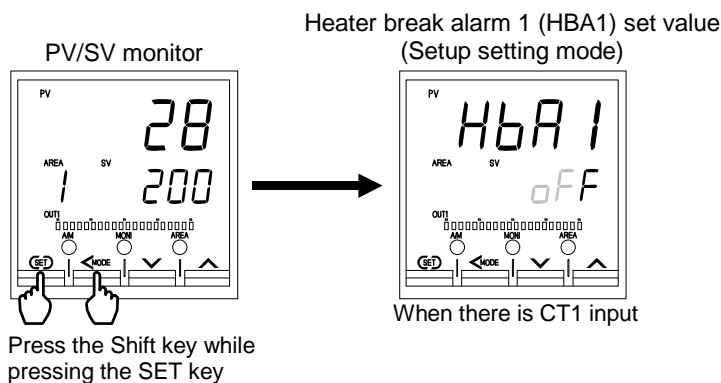

2. Press the SET key until Ratio setting bias screen is displayed.
Press the Shift key, UP key, or DOWN key and set the bias for the setting input (master SV) from the master.

Setting range: –Input span to +Input span (Factory set value: 0)

Ratio setting bias
(RS bias)

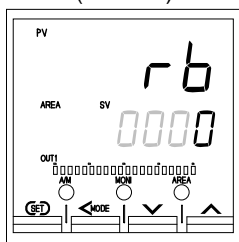

If the External input type is Remote setting input, the Ratio setting bias screen becomes the RS bias screen and if Intercontroller communication cascade control, it becomes the Cascade bias screen. In other places, this is indicated as “RS bias.”



After a new value is displayed on the display by using UP and DOWN keys, if no key operation is performed within 1 minute without pressing SET key, this instrument returns to the PV/SV monitor screen and the Ratio setting bias will not be changed.

3. Press the SET key to store the new Ratio setting bias. The screen goes to Ratio setting digital filter screen.

Press the Shift key, UP key, or DOWN key and set the digital filter for the setting input (master SV) from the master.

Setting range: 0.1 to 100.0 seconds

oFF: Unused (Factory set value: oFF)

Ratio setting digital filter
(RS digital filter)

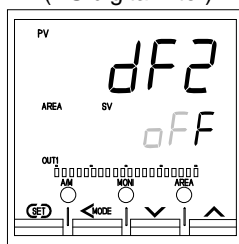

If the External input type is Remote setting input, the Ratio setting digital filter screen becomes the RS digital filter screen and if Intercontroller communication cascade control, it becomes the Cascade digital filter screen. In other places, this is indicated as “RS digital filter.”



After a new value is displayed on the display by using UP and DOWN keys, if no key operation is performed within 1 minute without pressing SET key, this instrument returns to the PV/SV monitor screen and the Ratio setting digital filter will not be changed.

- Press the SET key to store the new Ratio setting digital filter. The screen goes to Ratio setting ratio screen.

Press the Shift key, UP key, or DOWN key and set the ratio for the setting input (master SV) from the master.

Setting range: 0.001 to 9.999 (Factory set value: 1.000)

Ratio setting ratio
(RS ratio)

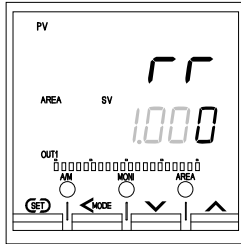

If the External input type is Remote setting input, the Ratio setting ratio screen becomes the RS ratio screen and if Intercontroller communication cascade control, it becomes the Cascade ratio screen. In other places, this is indicated as “RS ratio.”



After a new value is displayed on the display by using UP and DOWN keys, if no key operation is performed within 1 minute without pressing SET key, this instrument returns to the PV/SV monitor screen and the Ratio setting ratio will not be changed.

- Press the SET key to store the new Ratio setting ratio. The screen goes to the next parameter.

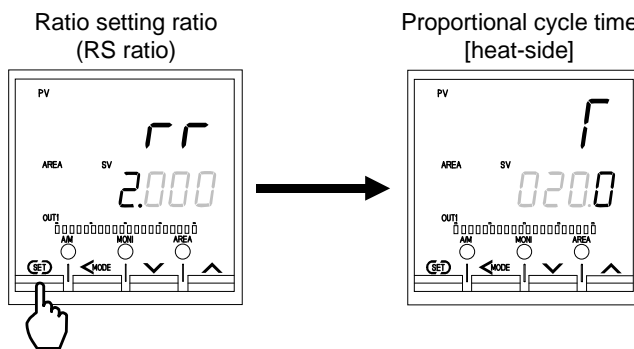

- To return the PV/SV monitor, press the MONI key (for Direct key Type 1), or press the Shift key while pressing the SET key.

- Set the Ratio setting bias, Ratio setting digital filter and Ratio setting ratio of the other slaves by the same procedures as described in steps 1 to 6 above.



For the setting procedure, refer to **5.2.2 Changing set value (SV) (P. 5-8)** or **6.3 Operating Setting (P. 6-5)**.

■ Operation procedures

1. Set the Device address 2 for each controller.

☞ For the Device address 2 setting, refer to **6.14.2 Common setting of the Intercontroller communication (P. 6-61)**.

2. Set the External input type for each controller.

Set “0: Remote setting (RS) input” to the master controller, and “2: Intercontroller communication ratio setting” to the slave controller.

☞ For the External input type setting, refer to **■ Settings before operation (P. 6-93)**.

3. Set the master for the ratio setting.

Set the address (setting of the Device address 2) of the controller which becomes the master at the controllers which become the slaves. Setting is unnecessary for the master.

☞ For the Master channel setting, refer to **■ Settings before operation (P. 6-93)**.

4. Change the slave controller to Remote mode. Ratio setting by Intercontroller communication can be executed if the slave controllers are in the Remote mode.

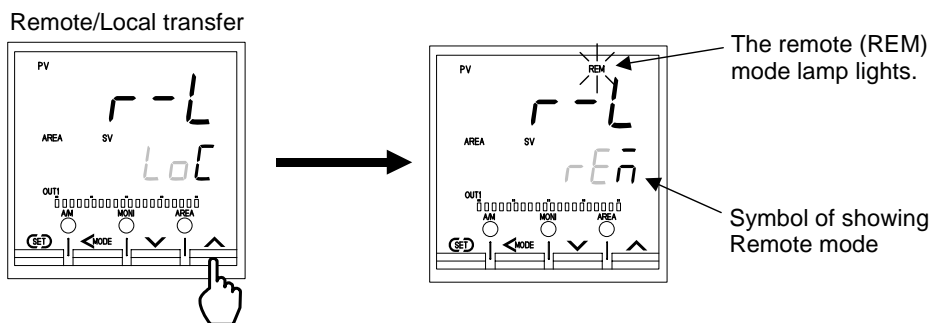

☞ To change from the Local mode to the Remote mode, refer to **6.8 Remote/Local Transfer (P. 6-28)**.

5. The settings above starts ratio setting by Intercontroller communication.

6. Perform Ratio setting bias, Ratio setting digital filter, and Ratio setting ratio adjustment which actually operating.

☞ For the Ratio setting bias, Ratio setting digital filter, and Ratio setting ratio, refer to **■ Adjustment after control starting (P. 6-96)**.

■ Usage example

● Example 1

Depending on the master channel setting, the following Master/Slave relationship can be established.

Controller No.	Device address 2	Set the Master channel	Master/Slave
1	0	—	Master — Slave — Slave/Master * — Slave — Slave — Slave
2	1	0	
3	2	0	
4	3	0	
5	4	2	
6	5	2	

* Controller No. 3 becomes a controller number 1 slave and the master of controller No. 5 and No. 6.

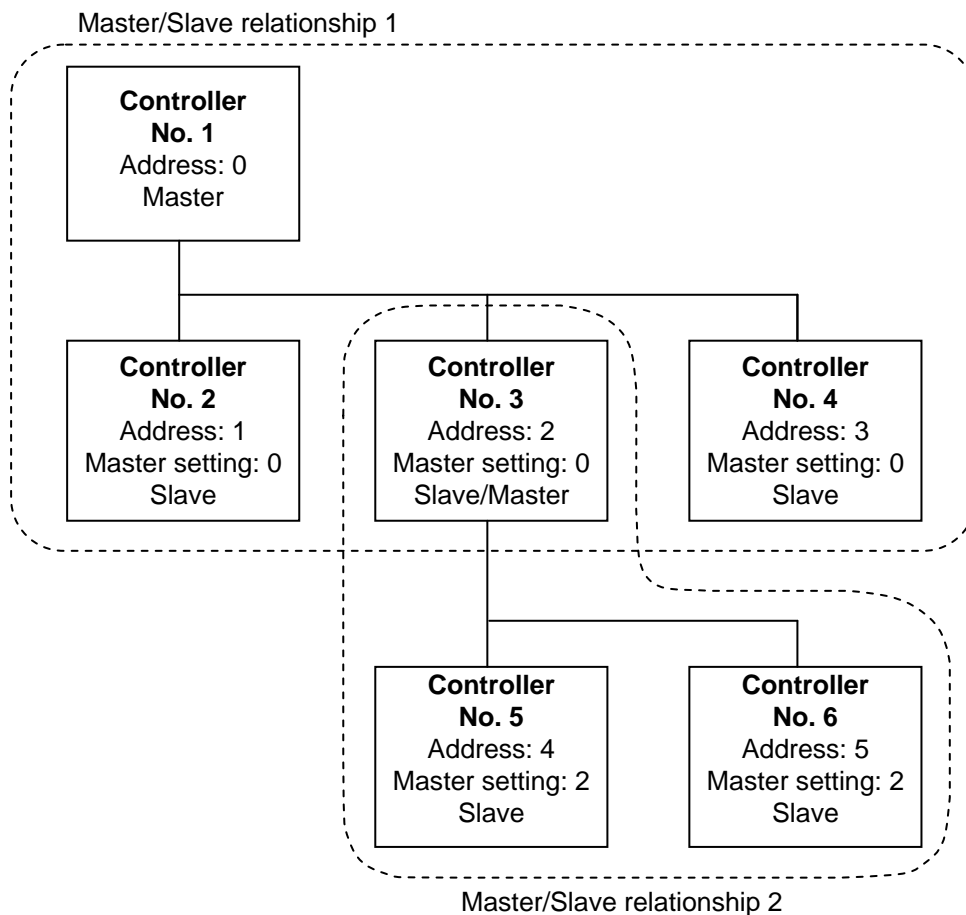

● **Example 2**

When ratio setting by Intercontroller communication by a connection like that shown below was performed, a difference in the master SV change and slave SV change is generated.

Input the program controller Set value (SV) to the ratio setting master by Intercontroller communication as Remote setting input.

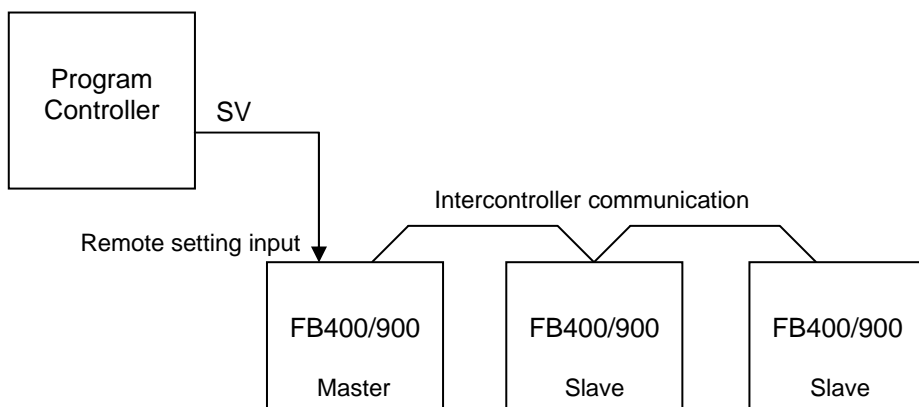

The master SV values continuously change gradually, the same as the program controller Set value (SV), but since there is a time lag due to Intercontroller communication, the slave SV changes in a stepped state.

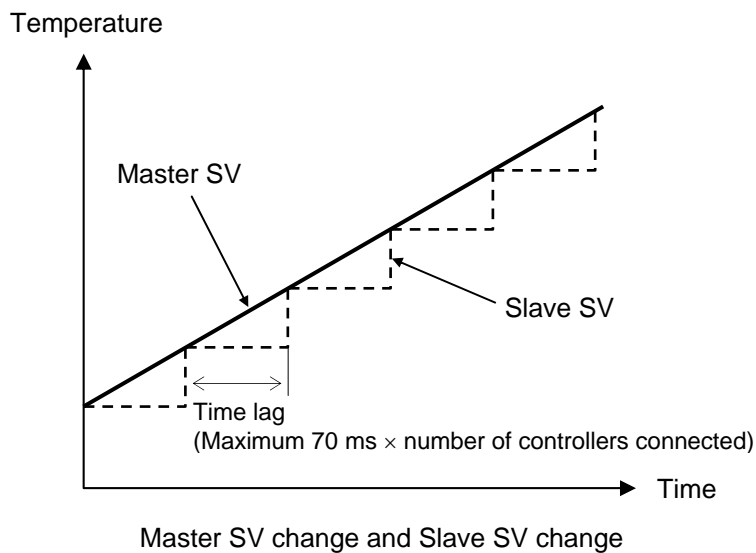

MEMO

PARAMETER DESCRIPTION

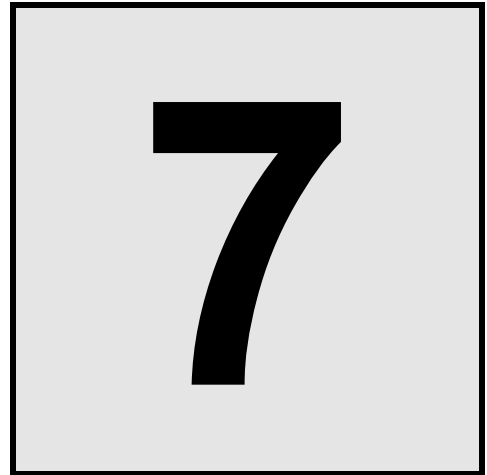

7.1 SV Setting & Monitor Mode	7-2
7.1.1 Display sequence (When the Direct key type is Type 1).....	7-2
7.1.2 Display sequence (When the Direct key type is Type 2).....	7-3
7.1.3 Monitor and setting item.....	7-4
7.2 Operation Mode	7-14
7.2.1 Display sequence.....	7-14
7.2.2 Operation item.....	7-15
7.3 Parameter Setting Mode	7-19
7.3.1 Display sequence.....	7-20
7.3.2 Parameter setting item.....	7-21
7.4 Setup Setting Mode	7-34
7.4.1 Display sequence.....	7-34
7.4.2 Setup setting item	7-35
7.5 Engineering Mode.....	7-48
7.5.1 Display Sequence	7-48
7.5.2 Precaution against parameter change	7-55
7.5.3 Engineering setting item.....	7-62

7.1 SV Setting & Monitor Mode

In SV setting & monitor mode, the following operations are possible.

- Change the Set value (SV)
- Change memory area
- Monitor the Measured value (PV) and the Manipulated output value (MV), etc.

The display sequence of SV setting & monitor mode display differs depending on the Direct key type. There are two types of direct key: Type 1 and Type2. They can be selected in Engineering mode.

7.1.1 Display sequence (When the Direct key type is Type 1)

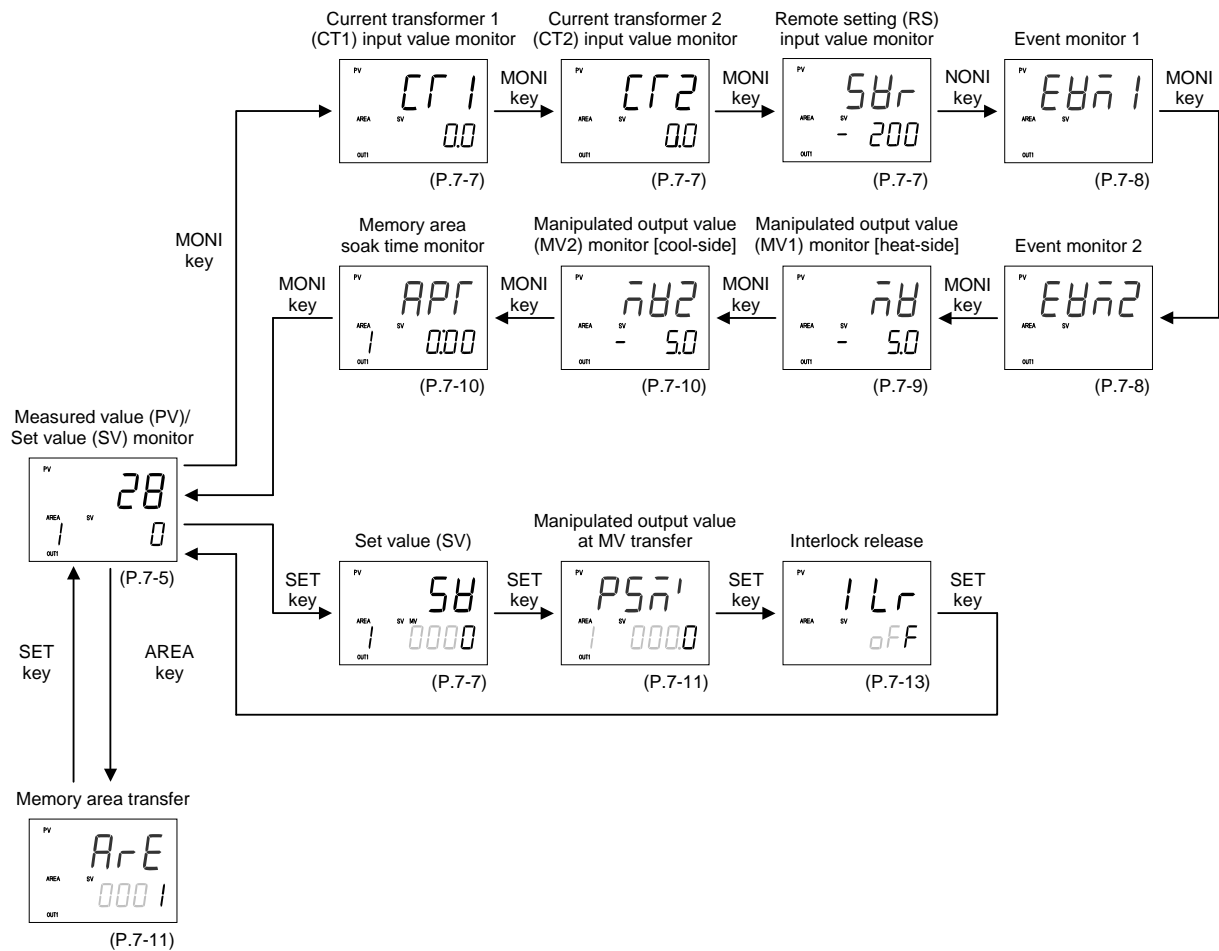

Some parameters may not be displayed when the relevant function is not set so as to be activated or no relevant specification is selected when ordering.



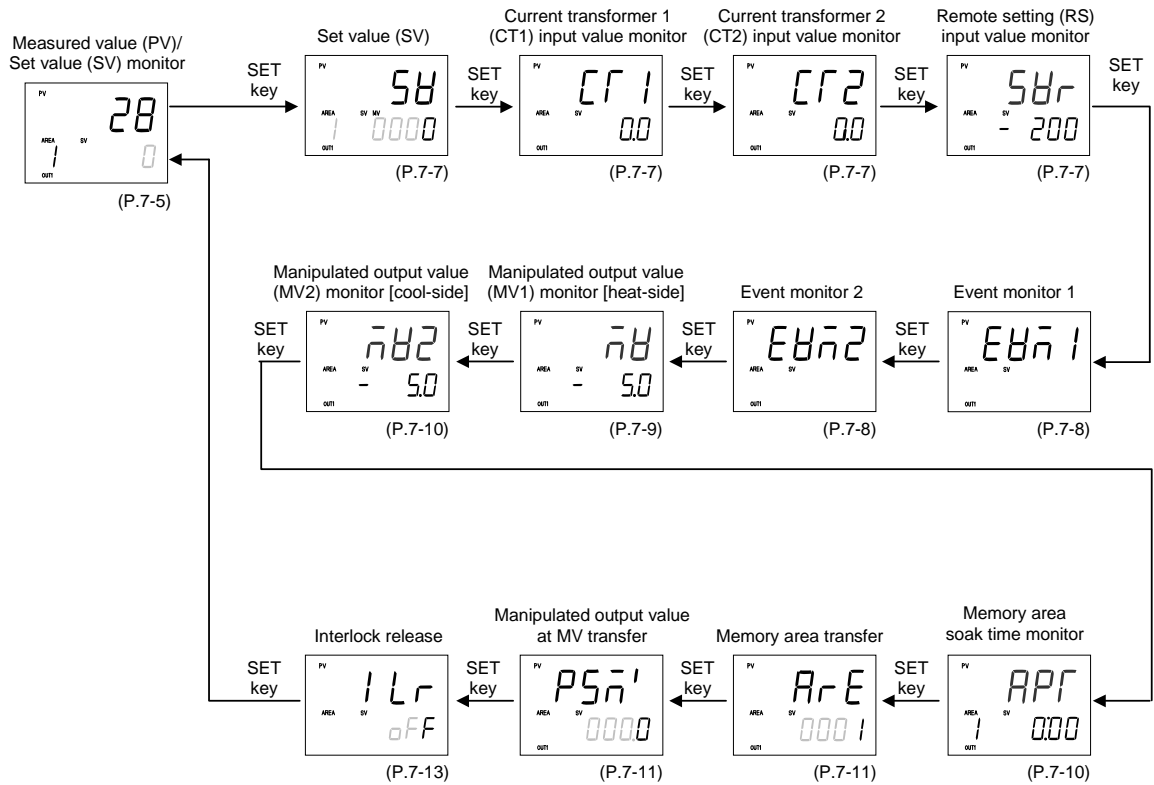





7.1.2 Display sequence (When the Direct key type is Type 2)



Some parameters may not be displayed when the relevant function is not set so as to be activated or no relevant specification is selected when ordering.

7.1.3 Monitor and setting item

■ Pictogram description

Pictogram	Name	Description
	Memory area function	Parameters which can be stored in the memory area
	Data lock function	Parameters which can be locked so that no data can be changed.
	Current transformer (CT) input	Parameters relating to any relevant optional for the FB400/900 having those optional.
	Feedback resistance (FBR) input	
	Communication function (Communication1 or Communication 2)	
	Power feed forward (PFF) input	
	Transmission output	
	Digital output (DO)	



Measured value (PV)/Set value (SV) monitor

PV monitor

28

SV monitor

0

Measured value (PV) display (hereinafter called the PV display):

Measured value (PV) is displayed.

Set value (SV) display (hereinafter called the SV display):

The target value for control is displayed. The value to be displayed varies depending on the state of operation mode.

- Set value (SV)* is displayed when the operation mode is Local mode.
- Remote setting input value (RS)* is displayed when operation mode is Remote mode.



On each controller on the slave side while in Intercontroller communication:

For Intercontroller communication ratio setting or Intercontroller communication cascade control, set the controller on the slave side to the remote mode. In this case, the displayed value is that obtained by adding digital filter, bias or ratio to the value from the controller on the master side.

- Manual manipulated output value is displayed when the operation mode is Manual mode. In addition, the Manipulated output value (MV) can be manually set. (Refer to P. 6-27)
 - In the PID control, displays the Manipulated output value (MV1) [heat-side].
 - In the Heat/Cool PID control, displays the Manipulated output value (MV1) [heat-side] or Manipulated output value (MV2) [cool-side].
 - When the control action is the Position proportioning PID control:
 - When the Feedback resistance (FBR) input is provided, Manipulated output value (MV) is displayed. In addition, when the Feedback resistance (FBR) input is not provided, nothing will appear in the SV display.

* With the Setting change rate limiter when the set value is changed, the displayed set value changes according to the ramp-up/down rate.

Display or data range	Factory set value
Measured value (PV): Input scale low to Input scale high Varies with the setting of the Decimal point position (P. 7-71).	—
Set value (SV) or Remote setting (RS) input value: Setting limiter low to Setting limiter high Varies with the setting of the Decimal point position (P. 7-71).	—
Manipulated output value (MV1 or MV2): PID control: Output limiter low (MV1) to Output limiter high (MV1) (-5.0 to +105.0 %) Heat/Cool PID control: -Output limiter high (MV2) to +Output limiter high (MV1) (-105.0 to +105.0 %)	—



In the STOP mode, displays the “5ΓOP” character on the PV or SV display. Display position of “5ΓOP” can be set in the Engineering mode (P. 7-62).



When Heat/Cool PID control is performed, it is necessary to select Output 2 (OUT2) when ordering.

■ Display processing of Measured value (PV) monitor

The value obtained after a captured input value is processed as shown in the following corresponds to the Measured value (PV) which will be displayed on the PV monitor.

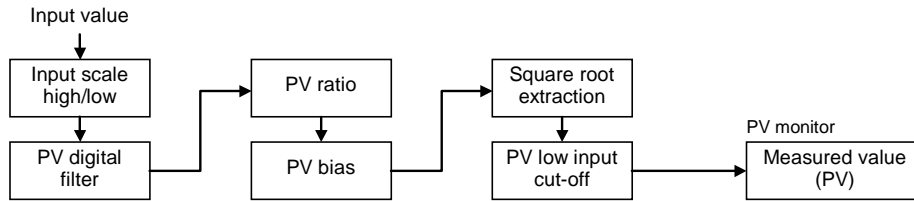

■ Display processing of Set value (SV) monitor

The value obtained after Remote setting (RS) input, Memory area set value (SV) or Local set value (SV) is processed as shown in the following corresponds to the Set value (SV) which will be displayed on the SV monitor.

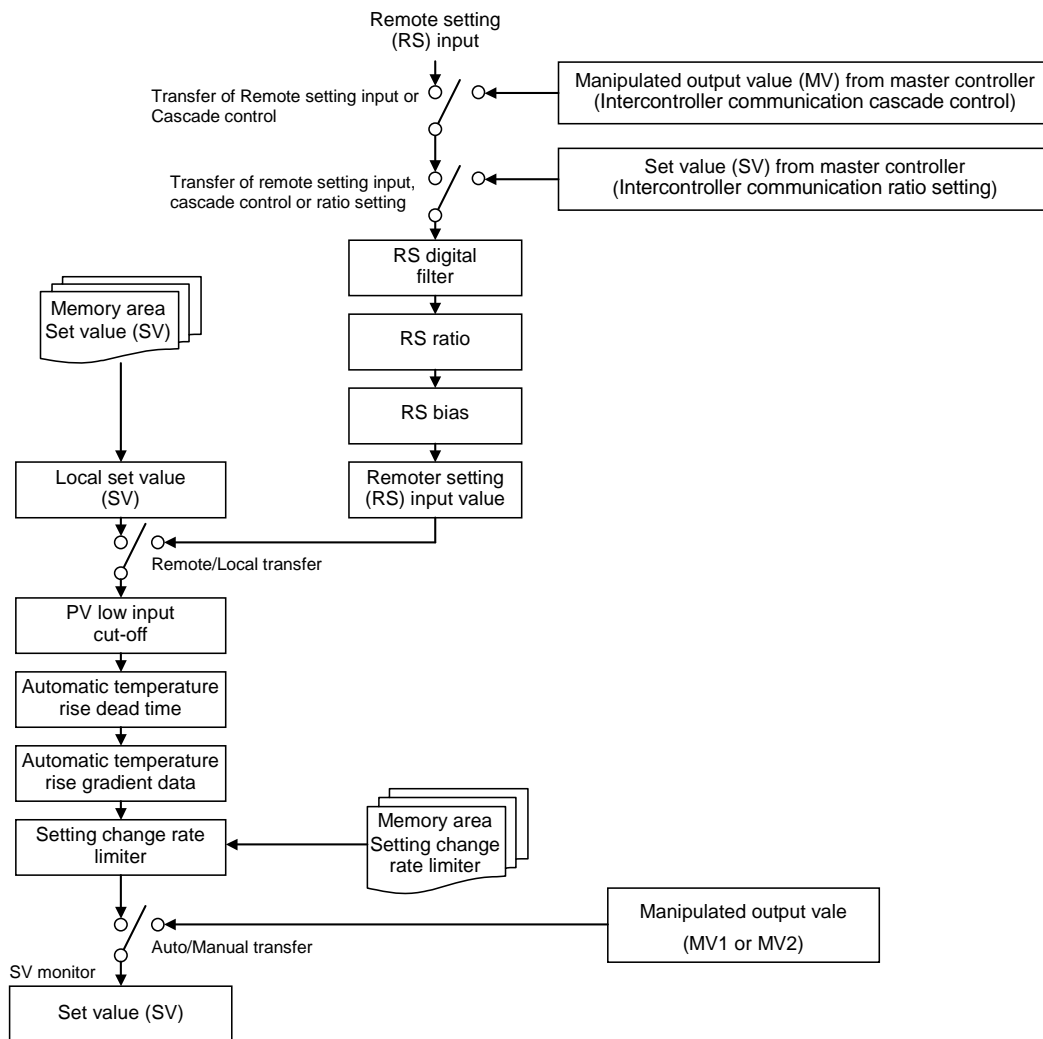

Set value (SV) [Local set value]



SV

The target value (Local set value) for control can be set.

Data range	Factory set value
Setting limiter low to Setting limiter high Varies with the setting of the Decimal point position (P. 7-71).	0

Related parameter

Engineering mode:

- Decimal point position (P. 7-71)
- Setting limiter high, Setting limiter low (P. 7-170)

Current transformer 1 (CT1) input value monitor Current transformer 2 (CT2) input value monitor



CT1

The current value captured by the Current transformer (CT) is displayed on the SV display.

CT2

Display range	Factory set value
When CT type is CTL-6-P-N: 0.0 to 30.0 A	—
When CT type is CTL-12-S56-10L-N: 0.0 to 100.0 A	—



This screen is displayed when the Current transformer (CT) input is provided.

Remote setting (RS) input value monitor

SVr

In remote mode, the Remote setting (RS) input value which becomes the target of control is displayed on the SV display.

Display range	Factory set value
Setting limiter low to Setting limiter high Varies with the setting of the Decimal point position (P. 7-71).	—



This screen is displayed when the Remote setting (RS) input is provided.

Related parameters

Operation mode:

- Remote/Local transfer (P. 7-18)

Setup setting mode:

- RS bias (P. 7-42) • RS digital filter (P. 7-42) • RS ratio (P. 7-42)

Engineering mode:

- Decimal point position (P. 7-71)
- Setting limiter high, Setting limiter low (P. 7-170)

Event monitor 1

In case of event occurrence, “□” is lit in the digit of the SV display. It is possible to check the type of created event depending on which digit was lit.

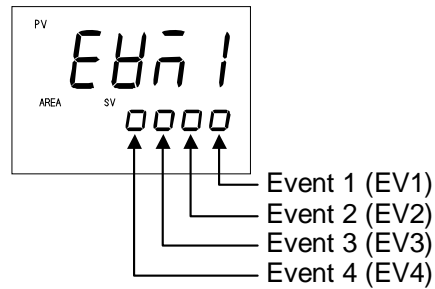

This screen is displayed when event action is selected for any from Event 1 type to Event 4 type.

Related parameters

Engineering mode:

- Event 1 type (P. 7-85)
- Event 2 type (P. 7-95)
- Event 3 type (P. 7-102)
- Event 4 type (P. 7-109)

Event monitor 2

CT
input
OPTION

In case of Heater break alarm (HBA) occurrence, “□” is lit in the digit of the SV display. It is possible to check the type of Heater break alarm (HBA) which occurred depending on which digit was lit.

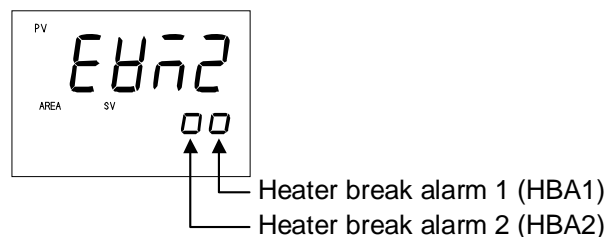

This screen is not displayed when set the CT assignment to “0: None.”

Related parameters

Engineering mode:

- CT1 assignment (P. 7-117)
- CT2 assignment (P. 7-121)

Manipulated output value (MV1) monitor [heat-side]

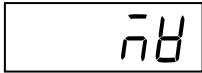

When the control action is PID control or Heat/Cool PID control:

Manipulated output value (MV1) is displayed on the SV display.

When the control action is the Position proportioning PID control:

When Feedback resistance (FBR) input (optional) is used, the SV display shows that Feedback resistance (FBR) input value.

Display details of SV display

Control action	Feedback resistance (FBR) input	Display details
PID control	FBR input is not used.	Manipulated output value (MV1) is displayed.
Heat/Cool PID control		Manipulated output value (MV1) [heat-side] is displayed.
Position proportioning PID control	Not provided	Nothing is displayed.
	Provided *	Feedback resistance (FBR) input value is displayed.

* When there is Feedback resistance (FBR) input but it is not connected, over-scaling may result to display “□□□□” on the SV display.

Display range	Factory set value
PID control or Heat/Cool PID control: -5.0 to +105.0 %	—
When Feedback resistance (FBR) input is used in Position proportioning PID control: 0.0 to 100.0 %	—



When Feedback resistance (FBR) input is disconnected, over-scaling may result to display “□□□□” on the display.

Manipulated output value (MV2) monitor [cool-side]

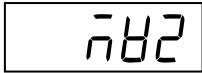

Manipulated output value (MV2) of cool-side is displayed.

Display range	Factory set value
-5.0 to +105.0 %	—

This screen is displayed when in Heat/Cool PID control.

Related parameter

Engineering mode:

- Control action (P. 7-129)

Memory area soak time monitor

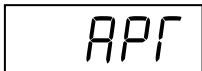

Monitors the time elapsed for memory area operation (soak time) when Ramp/Soak control by using Multi-memory area is performed.

Display example:

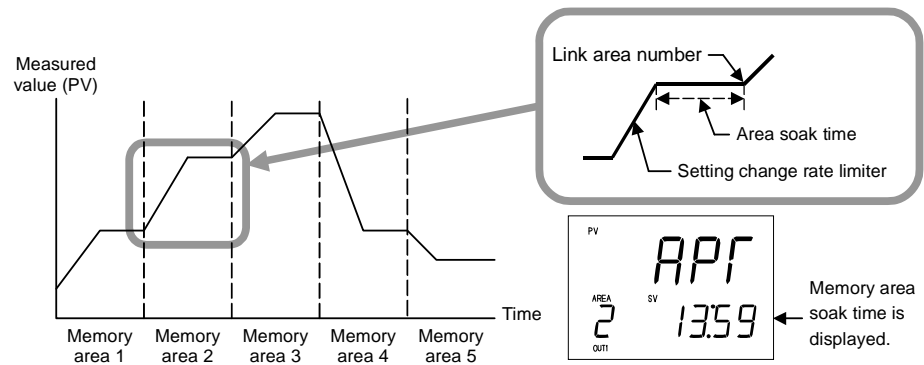

Display range	Factory set value
0 minutes 00 seconds to 199 minutes 59 seconds or 0 hours 00 minutes to 99 hours 59 minutes	—

Related parameters

Parameter setting mode:

- Area soak time (P. 7-32)
- Link area number (P. 7-33)

Engineering mode:

- Soak time unit (P. 7-169)

Memory area transfer

ARE

Selects the memory area (Control area) used for control.

Data range	Factory set value
1 to 8	1

 When the Direct key type is Type 1, pressing the AREA key can be changed to the memory area transfer screen.
Memory area transfer screen is displayed in SV setting & Monitor mode when the Direct key type is Type 2.

Related parameter

Engineering mode:

- Direct key type (P. 7-68)

Manipulated output value at MV transfer

PSn'

This is the final Manipulated output value used under Manual control when the control mode is transferred to Auto control from Manual control.

Data range	Factory set value
PID control: Output limiter low (MV1) to Output limiter high (MV1) (-5.0 to +105.0 %)	0.0
Heat/Cool PID control: -Output limiter high (MV2) to +Output limiter high (MV1) For overlap: -105.0 to +105.0 % * * Actual output value is limited by the output limiter function.	0.0

 This screen is not displayed when the MV transfer function is set to "0."

Related parameter

Engineering mode:

- MV transfer function (P. 7-128)

Continued on the next page.

Continued from the previous page.

■ **Description of function**

This is the final Manipulated output value used under Manual control when the control mode is transferred to Auto mode from Manual mode. This final Manipulated output value is stored and that displays on the Manipulated output value at MV transfer screen.

This final Manipulated output value is used as a Manipulated output value in Manual control when control mode is transferred to Manual mode next time. (MV transfer function)

Example 1:

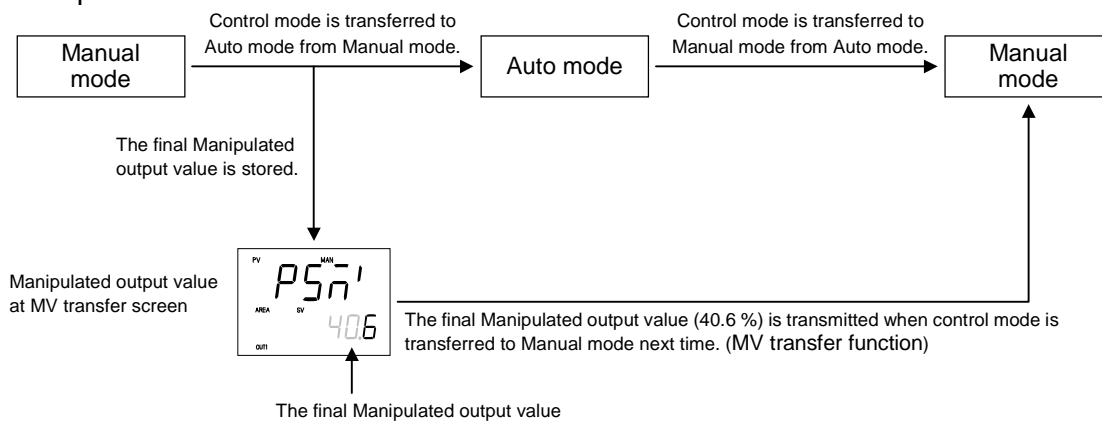

In addition, on this screen it is possible to manually change Manipulated output values (MV1 and MV2) in Auto mode. However, if they are changed in Auto mode, these manipulated output values thus changed are transferred when selected to the Manual mode next time.

Example 2:

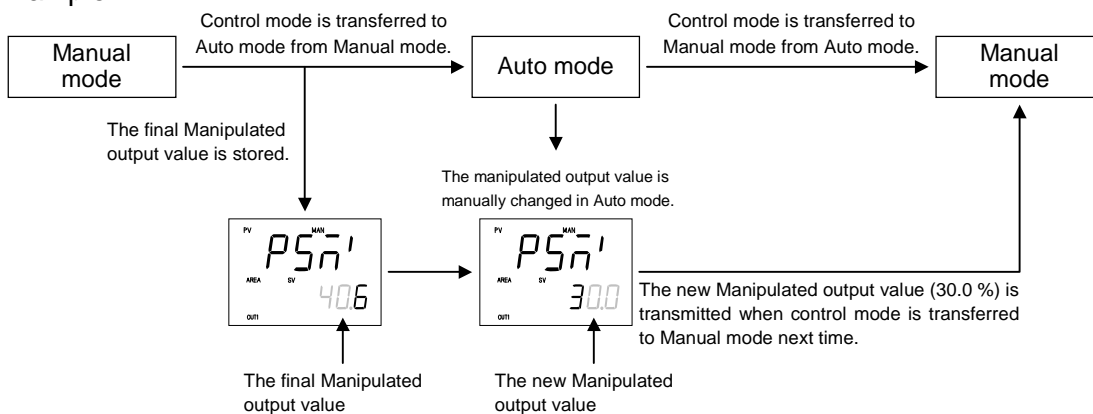

Manipulated output value can be changed by the UP, DOWN or shift keys.

Interlock release



Displays the interlock status.

If the event state is interlocked, interlock can be released by pushing the DOWN key.

Data range	Factory set value
on (on): Interlock	oFF (oFF)
oFF (oFF): Interlock release	



This screen is not displayed when all of Event 1 interlock to Event 4 interlock are set to “Unused.”

Related parameters

Engineering mode:

- Event 1 interlock (P. 7-89)
- Event 2 interlock (P. 7-98)
- Event 3 interlock (P. 7-105)
- Event 4 interlock (P. 7-112)

7.2 Operation Mode

The Operation mode is used to select the operation modes (PID/AT, Auto/Manual, Remote/Local or RUN/STOP) of the instrument.

In addition, the Startup tuning (ST) and Automatic temperature rise learning function can be set.

7.2.1 Display sequence

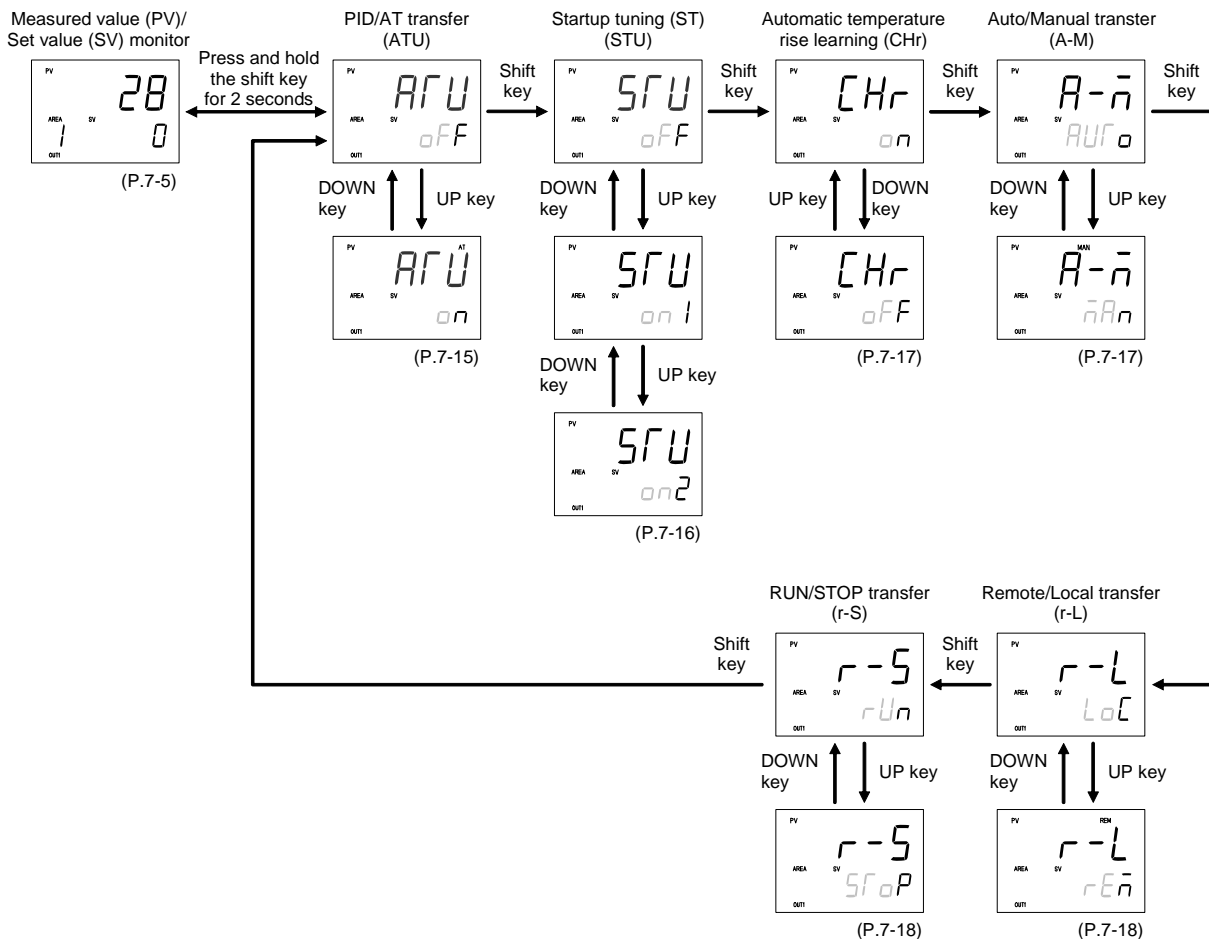

The SET key as well as the shift key enables the transfer of operation items.



Some parameters may not be displayed when the relevant function is not set so as to be activated or no relevant specification is selected when ordering.



Display returns to the SV setting & monitor mode if no key operation is performed within 1 minute.

7.2.2 Operation item

PID/AT transfer

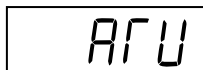

Activation or deactivation of the Autotuning (AT) function is selected.

Data range	Factory set value
on (on): Autotuning (AT) oFF (oFF): PID control	oFF (oFF)

For the activating method and condition of the Autotuning (AT) function, refer to **6.5 Autotuning (AT) (P. 6-15)**.

Related parameters

Engineering mode:



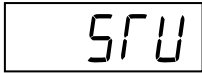

- AT bias (P. 7-146)
- AT cycles (P. 7-147)
- AT differential gap time (P. 7-148)
- Output value with AT turned on, Output value with AT turned off (P. 7-149)
- Proportional band limiter (high) [heat-side],
Proportional band limiter (low) [heat-side] (P. 7-150)
- Integral time limiter (high) [heat-side],
Integral time limiter (low) [heat-side] (P. 7-151)
- Derivative time limiter (high) [heat-side],
Derivative time limiter (low) [heat-side] (P. 7-152)
- Proportional band limiter (high) [cool-side],
Proportional band limiter (low) [cool-side] (P. 7-153)
- Integral time limiter (high) [cool-side],
Integral time limiter (low) [cool-side] (P. 7-154)
- Derivative time limiter (high) [cool-side],
Derivative time limiter (low) [cool-side] (P. 7-155)
- Proportional band adjusting factor [heat-side],
Proportional band adjusting factor [cool-side] (P. 7-156)
- Integral time adjusting factor [heat-side],
Integral time adjusting factor [cool-side] (P. 7-156)
- Derivative time adjusting factor [heat-side],
Derivative time adjusting factor [cool-side] (P. 7-157)

Startup tuning (ST)



Use to set the number of execution times of Startup tuning (ST).

Data range	Factory set value
on1 (on1): Execute once	oFF (oFF)
on2 (on2): Execute always	
oFF (oFF): ST unused	

-  This screen is displayed when in Position proportioning PID control.
-  When in Heat/Cool PID control, it is possible to execute the Startup tuning (ST) function only in the temperature rise direction. The PID values on the heat side are automatically computed.
-  If the optimum PID constants cannot be obtained by the Startup tuning (ST), please execute the Autotuning (AT).
-  For details of the Startup tuning (ST), refer to **6.6 Startup Tuning (ST) (P. 6-18)**.

Related parameters

Engineering mode:

- ST proportional band adjusting factor (P. 7-163)
- ST integral time adjusting factor (P. 7-164)
- ST derivative time adjusting factor (P. 7-164)
- ST start condition (P. 7-163)

■ Description of function

The Startup tuning (ST) function is used to automatically compute PID constants from the temperature rise characteristic (gradient: arrival time to SV) when power is turned on or the Set value (SV) is changed. If the Startup tuning (ST) function is used for any equipment which requires a long period of time for executing the Autotuning (AT) function, no time of executing the Autotuning (AT) function becomes necessary.

Timing of activating the Startup tuning (ST) can be selected from among the following three types.

- Activate the Startup tuning (ST) function when the power is turned on; when transferred from STOP to RUN; or when the Set value (SV) is changed.
- Activate the Startup tuning (ST) function when the power is turned on; or when transferred from STOP to RUN.
- Activate the Startup tuning (ST) function when the Set value (SV) is changed.

Activate the Startup tuning (ST) function when the power is turned on; or when transferred from STOP to RUN.

Activate the Startup tuning (ST) function when the Set value (SV) is changed.

Activate the Startup tuning (ST) function when the power is turned on; when transferred from STOP to RUN; or when the Set value (SV) is changed.

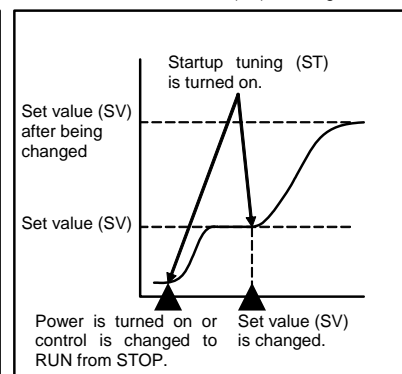
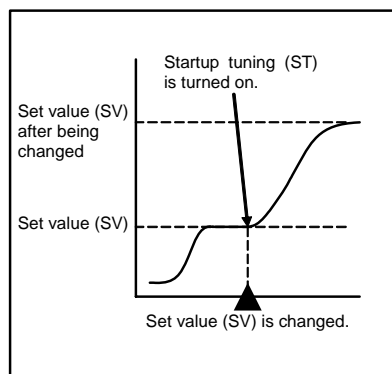
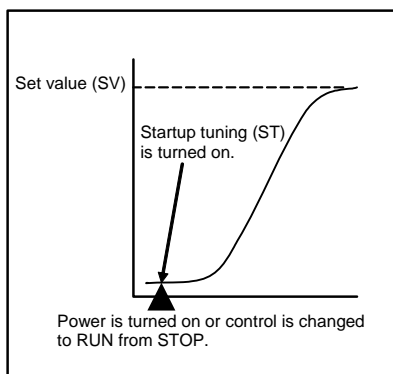

Automatic temperature rise learning

Use to select Use/Unuse of the Automatic temperature rise learning function.

Data range	Factory set value
on (on): Learning oFF (oFF): Unused	on (on)

- This screen is not displayed when set the Automatic temperature rise group to “0.”
- When in Heat/Cool PID control, an Automatic temperature rise only in the temperature rise direction is enabled.
- For details of the Automatic temperature rise learning function, refer to **6.14.4 Automatic temperature rise function (with learning function) (P. 6-72)**.

Related parameters

Engineering mode:

- Automatic temperature rise group (P. 7-165)
- Automatic temperature rise dead time (P. 7-167)
- Automatic temperature rise gradient data (P. 7-167)

■ Description of function

This is the function to find Automatic temperature rise dead time and Automatic temperature rise gradient data necessary for an Automatic temperature rise. Learning starts if set to “on: Learning” and changed to control RUN to STOP. After Automatic temperature rise dead time and Automatic temperature rise gradient data are found, the learning function is deactivated.

Auto/Manual transfer

Use to transfer the Auto mode or Manual mode.

Auto mode: Automatic control is performed.

Manual mode: The Manipulated output value (MV1 or MV2) can be manually changed. The Manipulated output value can be changed on the Measured value (PV)/Set value (SV) monitor.

Data range	Factory set value
AUFo (AUTo): Auto mode nAn (MAn): Manual mode	AUFo (AUTo)

- Even when in Auto mode, it is possible to manually change the manipulated output value on the Manipulated output value at MV transfer screen.
- For details of the Auto/Manual transfer, refer to **6.7 Auto/Manual transfer (P. 6-23)**.

Remote/Local transfer

r-L

Use to transfer the Remote mode or Local mode.

Local mode: Control is performed at the Local set value (SV).

Remote mode: Control is performed with a Remote setting (RS) input value.

Data range	Factory set value
LoC (LoC): Local mode	LoC (LoC)
rEn (rEM): Remote mode	

 For Intercontroller communication ratio setting or Intercontroller communication cascade control, set the controller on the slave side to the Remote mode.

 For details of the Remote/Local transfer, refer to **6.8 Remote/Local Transfer (P. 6-28)**.

 For details of the Intercontroller communication function, refer to **6.14 Group Operation by the Intercontroller Communication (P. 6-60)**.

Related parameters

Engineering mode:

- External input type (P. 7-125)
- SV tracking (P. 7-127)

RUN/STOP transfer

r-S

Use to transfer the RUN (control RUN) or STOP (control STOP).

Data range	Factory set value
rUn (rUn): RUN (Control RUN)	rUn (rUn)
StoP (StoP): STOP (Control STOP)	

 For details of the RUN/STOP transfer, refer to **6.4 RUN/STOP Transfer (P. 6-11)**.

 If the Group RUN/STOP function is used, refer to **6.14.3 Group RUN/STOP function (P. 6-63)**.

7.3 Parameter Setting Mode

Parameters of Parameter setting mode can be stored in the memory area.

■ Multi-memory area function

Multi-memory area function can store up to 8 individual sets of SVs and parameters in Parameter setting mode.

One of the Areas is used for control, and the currently selected area is Control area.

If the set values are stored in divided memory areas for each work process, it is possible to collectively call up all of these set values necessary for the process simply by changing the corresponding memory area numbers.

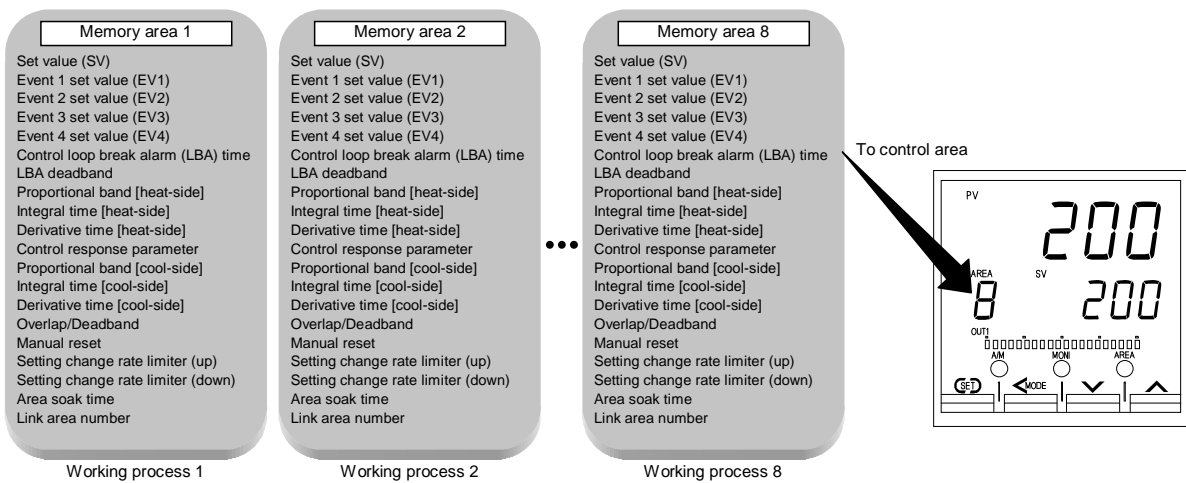

In addition, it is possible to perform Ramp/Soak control by linking each memory area. It is possible to perform Ramp/Soak control of up to 16 segments (8 steps).

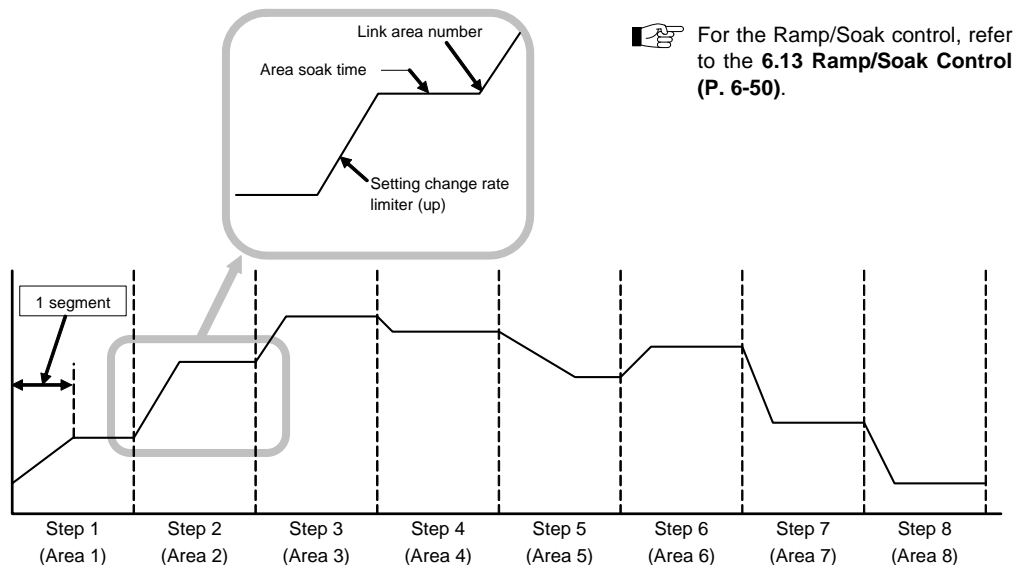

For the Ramp/Soak control, refer to the **6.13 Ramp/Soak Control (P. 6-50)**.

7.3.1 Display sequence

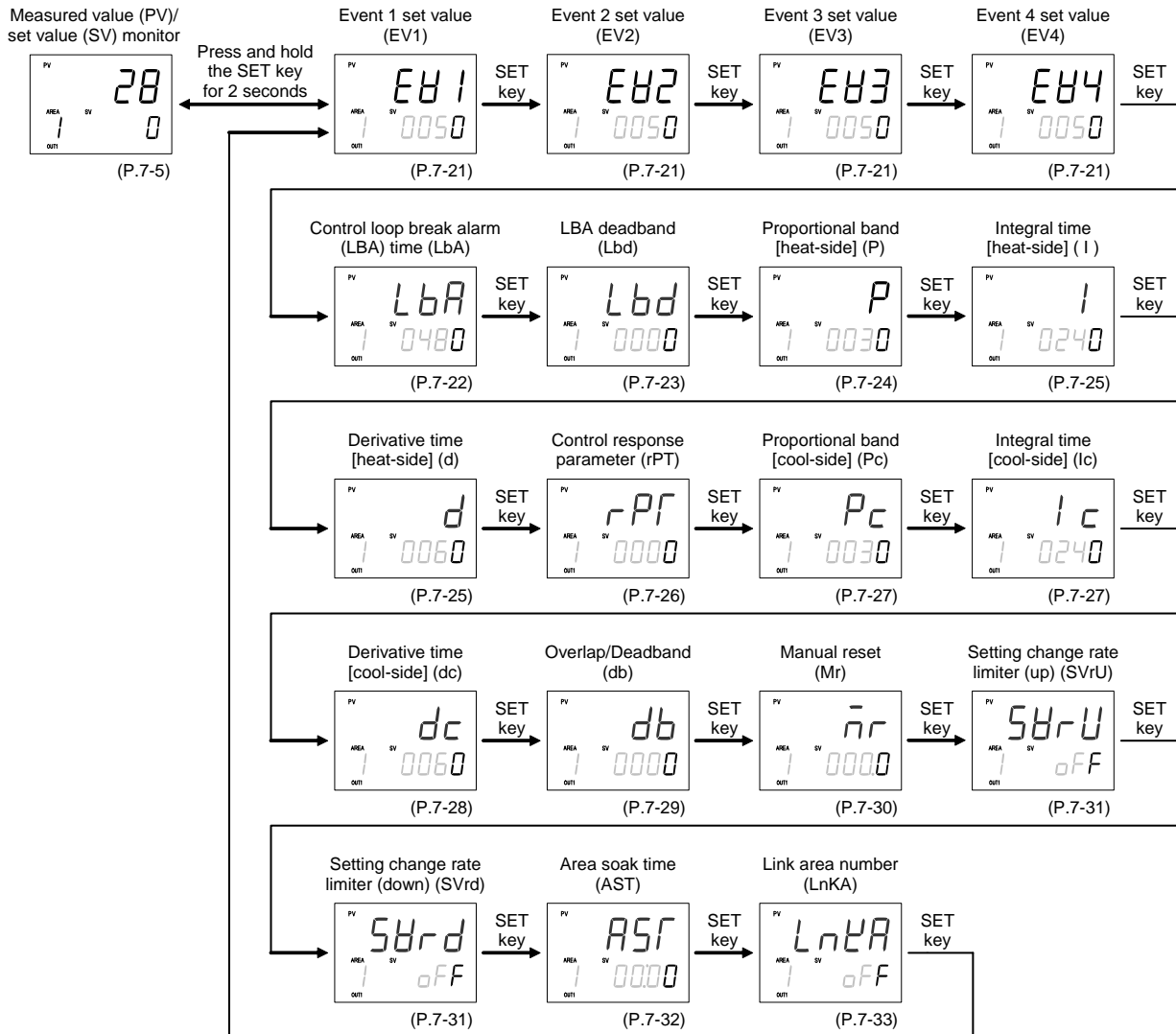

Some parameters may not be displayed when the relevant function is not set so as to be activated or no relevant specification is selected when ordering.



Display returns to the SV setting & monitor mode if no key operation is performed within 1 minute.

7.3.2 Parameter setting item

Event 1 set value (EV1) Event 3 set value (EV3)
Event 2 set value (EV2) Event 4 set value (EV4)



EV1

EV2

EV3

EV4

EV1 to EV4 are set values of the Event action.

Signals are output from the digital outputs (DO1 to DO4) if exceeding the Event set value.

Data range	Factory set value
When the event action is the deviation*: –Input span to +Input span Varies with the setting of the Decimal point position (P. 7-71).	50
* Deviation: Deviation high, Deviation low, Deviation high/low and Band	
When the event action is the input value or set value: Input scale low to Input scale high Varies with the setting of the Decimal point position (P. 7-71).	50
When the event action is the manipulated output value (MV1 or MV2): –5.0 to +105.0 %	50

These screens are not displayed when the type of the Event 1, 2, 3 and 4 is set to “0: None.”

The Event 4 set value (EV4) screen is not displayed when the Event 4 is used as a “9: Control loop break alarm (LBA).”

For the setting method of Event set value, refer to **6.3.2 Set the event set value (alarm set value) (P. 6-6)**.

Related parameters

Engineering mode:

- Decimal point position (P. 7-71)
- Alarm (ALM) lamp lighting condition 1 (P. 7-81)
- Event 1 type (P. 7-85)
- Event 2 type (P. 7-95)
- Event 3 type (P. 7-102)
- Event 4 type (P. 7-109)
- Event 1 hold action (P. 7-87)
- Event 2 hold action (P. 7-97)
- Event 3 hold action (P. 7-104)
- Event 4 hold action (P. 7-111)
- Event 1 interlock (P. 7-89)
- Event 2 interlock (P. 7-98)
- Event 3 interlock (P. 7-105)
- Event 4 interlock (P. 7-112)
- Event 1 differential gap (P. 7-90)
- Event 2 differential gap (P. 7-99)
- Event 3 differential gap (P. 7-106)
- Event 4 differential gap (P. 7-113)
- Event 1 delay timer (P. 7-91)
- Event 2 delay timer (P. 7-100)
- Event 3 delay timer (P. 7-107)
- Event 4 delay timer (P. 7-114)
- Force ON of Event 1 action (P. 7-93)
- Force ON of Event 2 action (P. 7-101)
- Force ON of Event 3 action (P. 7-108)
- Force ON of Event 4 action (P. 7-115)



Control loop break alarm (LBA) time

LBA

The LBA time sets the time required for the LBA function to determine there is a loop failure. When the LBA is output (under alarm status), the LBA function still monitors the Measured value (PV) variation at an interval of the LBA time.

Data range	Factory set value
1 to 7200 seconds OFF (oFF): Unused	480

The Event 4 set value (EV4) screen is displayed when the Event 4 is used as a “9: Control loop break alarm (LBA).”

Related parameters

Parameter setting mode:

- LBA deadband (P. 7-23)

Engineering mode:

- Event 4 type (P. 7-109)
- Event 4 interlock (P. 7-112)
- Event 4 delay timer (P. 7-114)

■ Description of function

The Control loop break alarm (LBA) function is used to detect a load (heater) break or a failure in the external actuator (power controller, magnet relay, etc.), or a failure in the control loop caused by an input (sensor) break. The LBA function is activated when control output reaches 0 % (low limit with output limit function) or 100 % (high limit with output limit function). LBA monitors variation of the Measured value (PV) for the length of LBA time. When the LBA time has elapsed and the PV is still within the alarm determination range, the LBA will be ON.

[Alarm action]

LBA determination range: TC/RTD inputs: 2 °C [°F] (fixed)
Voltage/Current inputs: 0.2 % of input span (fixed)

• When the output reaches 0 % (low limit with output limit function)

For direct action: When the LBA time has passed and the PV has not risen beyond the alarm determination range, the alarm will be turned on.

For reverse action: When the LBA time has passed and the PV has not fallen below the alarm determination range, the alarm will be turned on.

• When the output exceeds 100 % (high limit with output limit function)

For direct action: When the LBA time has passed and the PV has not fallen below the alarm determination range, the alarm will be turned on.

For reverse action: When the LBA time has passed and the PV has not risen beyond the alarm determination range, the alarm will be turned on.



If the Autotuning function is used, the LBA time is automatically set twice as large as the Integral time. The LBA setting time will not be changed even if the Integral time is changed.

LBA deadband



Lbd

The LBA deadband gives a neutral zone to prevent the Control loop break alarm (LBA) from malfunctioning caused by disturbance.

Data range	Factory set value
0 to Input span Varies with the setting of the Decimal point position (P. 7-71).	0

The Event 4 set value (EV4) screen is displayed when the Event 4 is used as a “9: Control loop break alarm (LBA).”

Related parameters

Parameter setting mode:

- Control loop break alarm (LBA) time (P. 7-22)

Engineering mode:

- Decimal point position (P. 7-71)
- Event 4 type (P. 7-109)
- Event 4 interlock (P. 7-112)
- Event 4 delay timer (P. 7-114)

■ Description of function

The LBA may malfunction due to external disturbances. To prevent malfunctioning due to external disturbance, LBA deadband (LBD) sets a neutral zone in which LBA is not activated. When the Measured value (PV) is within the LBD area, LBA will not be activated. If the LBD setting is not correct, the LBA will not work correctly.

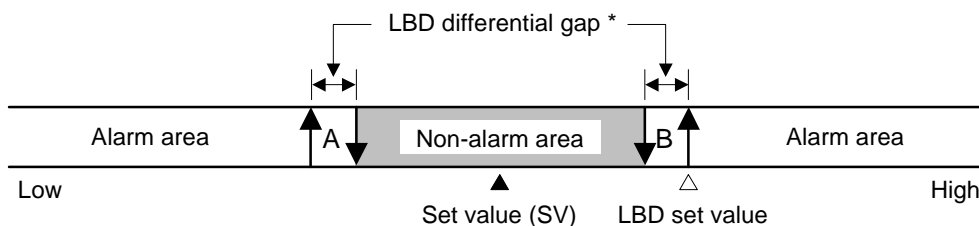

* TC/RTD inputs: 0.8 °C [°F] (fixed) Voltage/Current inputs: 0.8 % of input span (fixed)

A: During temperature rise: Alarm area During temperature fall: Non-alarm area

B: During temperature rise: Non-alarm area During temperature fall: Alarm area



If the LBA function detects an error occurring in the control loop, but cannot specify the location, a check of the control loop in order. The LBA function does not detect a location which causes alarm status. If LBA alarm is ON, check each device or wiring of the control loop.

Continued on the next page.

Continued from the previous page.



LBA function is not operative when:

- AT function is activated.
- The controller is in STOP mode.
- The control type is Heat/Cool PID control.
- LBA function is set to “0.”
- LBA function is not assigned to Event 4 (ES4).



If the LBA time is too short or does not match the controlled object requirements, LBA may turn ON or OFF at inappropriate time or remain OFF. Change the LBA time based on the malfunction.



While the LBA is ON (under alarm status), the following conditions cancel the alarm status and LBA will be OFF:

- The Measured value (PV) rises beyond (or falls below) the LBA determination range within the LBA time.
- The Measured value (PV) enter within the LBA deadband.

Proportional band [heat-side]



This is a Proportional band in P, PI, PD or PID control. When in Heat/Cool PID control, it becomes the Proportional band on the heat side.

Data range	Factory set value
TC/RTD inputs: 0 (0.0, 0.00) to Input span (Unit: °C [°F]) 0 (0.0, 0.00): ON/OFF action Varies with the setting of the Decimal point position (P. 7-71).	30 (30.0, 30.00)
Voltage (V)/Current (I) inputs: 0.0 to 1000.0 % of input splay 0.0: ON/OFF action	30.0

Related parameters

Parameter setting mode:

- Overlap/Deadband (P. 7-29)

Engineering mode:

- Decimal point position (P. 7-71)
- ON/OFF action differential gap (upper),
ON/OFF action differential gap (lower) (P. 7-134)
- Overlap/Deadband reference point (P. 7-144)

Integral time [heat-side]

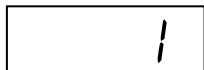

Integral action is to eliminate offset between SV and PV by proportional action. The degree of Integral action is set by time in seconds.

When in Heat/Cool PID control, it becomes the Integral time on the heat side.

Data range	Factory set value
PID control or Heat/Cool PID control: 1 to 3600 seconds or 0.1 to 1999.9 seconds □FF (oFF): PD action (Heat/Cool PID control: heat-side and cool-side are both PD action)	240
Position proportioning PID control: 1 to 3600 seconds or 0.1 to 1999.9 seconds	240

Data range varies depending on the Integral/Derivative time decimal point position (P. 7-133).

Data range	Integral/Derivative time decimal point position setting
1 to 3600 seconds or 1 to 3600 seconds	0: 1 second setting (No decimal place)
0.1 to 1999.9 seconds	1: 0.1 seconds setting (One decimal place)

Related parameter

Engineering mode:

- Integral/Derivative time decimal point position (P. 7-133)

Derivative time [heat-side]

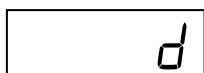

Derivative action is to prevent rippling and make control stable by monitoring output change. The degree of Derivative action is set by time in seconds.

When in Heat/Cool PID control, it becomes the Derivative time on the heat side.

Data range	Factory set value
1 to 3600 seconds or 0.1 to 1999.9 seconds □FF (oFF): PI action	60

Data range varies depending on the Integral/Derivative time decimal point position (P. 7-133).

Data range	Integral/Derivative time decimal point position setting
1 to 3600 seconds	0: 1 second setting (No decimal place)
0.1 to 1999.9 seconds	1: 0.1 seconds setting (One decimal place)

Related parameters

Engineering mode:

- Integral/Derivative time decimal point position (P. 7-133)
- Derivative gain (P. 7-133)



Control response parameter

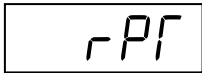

The control response for the Set value (SV) change can be selected among Slow, Medium, and Fast.

Data range	Factory set value
0: Slow	PID control, Position
1: Medium	proportioning PID control: 0
2: Fast	Heat/Cool PID control: 2

■ Description of function

The control response for the Set value (SV) change can be selected among Slow, Medium, and Fast. If a fast response is required, Fast is chosen. Fast may cause overshoot. If overshoot is critical, Slow is chosen.

Fast	Selected when rise time needs to be shortened (operation needs to started fast). However in this case, slight overshooting may not be avoided.
Medium	Middle between “Fast” and “Slow.” Overshooting when set to “Medium” becomes less than that when set to “Fast.”
Slow	Selected when no overshooting is allowed. Used when material may be deteriorated if the temperature becomes higher that the set value.

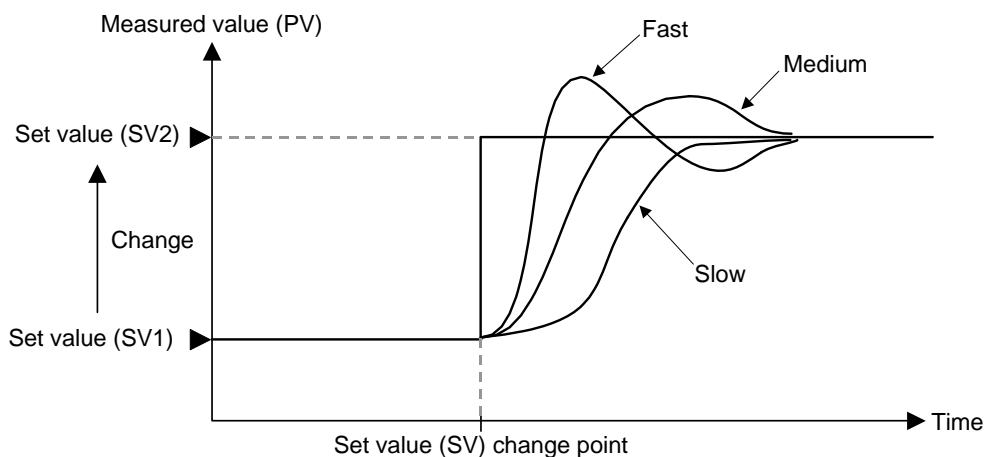

When the P or PD action is selected, this setting becomes invalid.

Proportional band [cool-side]



P_c

This is a Proportional band for the cool side in Heat/Cool P, PI, PD or PID control.

Data range	Factory set value
TC/RTD inputs: 1 (0.1, 0.01) to Input span (Unit: °C [°F]) Varies with the setting of the Decimal point position (P. 7-71).	30 (30.0, 30.00)
Voltage (V)/Current (I) inputs: 0.1 to 1000.0 % of input span	30.0

This screen is displayed when in Heat/Cool PID control.

Related parameters

Parameter setting mode:

- Overlap/Deadband (P. 7-29)

Engineering mode:

- Decimal point position (P. 7-71)
- Control action (P. 7-129)
- Overlap/Deadband reference point (P. 7-144)

Integral time [cool-side]



I_c

Integral action [cool-side] is to eliminate offset between SV and PV by proportional action of cool-side. The degree of Integral action [cool-side] is set by time in seconds.

Data range	Factory set value
1 to 3600 seconds or 0.1 to 1999.9 seconds oFF (oFF): PD action (Heat/Cool PID control: heat-side and cool-side are both PD action)	240

Data range varies depending on the Integral/Derivative time decimal point position (P. 7-133).

Data range	Integral/Derivative time decimal point position setting
1 to 3600 seconds	0: 1 second setting (No decimal place)
0.1 to 1999.9 seconds	1: 0.1 seconds setting (One decimal place)

This screen is displayed when in Heat/Cool PID control.

Related parameters

Engineering mode:

- Control action (P. 7-129)
- Integral/Derivative time decimal point position (P. 7-133)



Derivative time [cool-side]

dc

Derivative action of cool-side is to prevent rippling and make control stable by monitoring output change. The degree of Derivative action [cool-side] is set by time in seconds.

Data range	Factory set value
1 to 3600 seconds or 0.1 to 1999.9 seconds OFF (oFF): PI action	60

Data range varies depending on the Integral/Derivative time decimal point position (P. 7-133).

Data range	Integral/Derivative time decimal point position setting
1 to 3600 seconds	0: 1 second setting (No decimal place)
0.1 to 1999.9 seconds	1: 0.1 seconds setting (One decimal place)

This screen is displayed when in Heat/Cool PID control.

Related parameters

Engineering mode:

- Control action (P. 7-129)
- Integral/Derivative time decimal point position (P. 7-133)
- Derivative gain (P. 7-133)

Overlap/Deadband



db

This is the overlapped range of Proportional bands (on the heat and cool sides) or the deadband range when Heat/Cool PID control is performed.

Data range	Factory set value
TC/RTD inputs: –Input span to +Input span (Unit: °C [°F]) Varies with the setting of the Decimal point position (P. 7-71).	0
Voltage (V)/Current (I) inputs: –100.0 to +100.0 % of Input span	0.0

Minus (–) setting results in Overlap. However, the overlapping range is limited to the Proportional band [heat-side] set range or the Proportional band [cool-side] set range, whichever is smaller.

This screen is displayed when in Heat/Cool PID control.

Related parameters

Parameter setting mode:

- Proportional band [heat-side] (P. 7-24)
- Proportional band [cool-side] (P. 7-27)

Engineering mode:

- Decimal point position (P. 7-71)
- Control action (P. 7-129)
- Overlap/Deadband reference point (P. 7-144)

■ Description of function

Overlap (OL): Range in which the Proportional band [heat-side] and the Proportional band [cool-side] are overlapped. If a Measured value (PV) is within the overlapped range, Manipulated output values (MV1 and MV2) may be simultaneously output.

Deadband (DB): This is a control dead zone existing between the Proportional band [heat-side] and the Proportional band [cool-side]. If a Measured value (PV) is within the deadband range, neither the Manipulated output value (MV1) nor the Manipulated output value (MV2) is output.

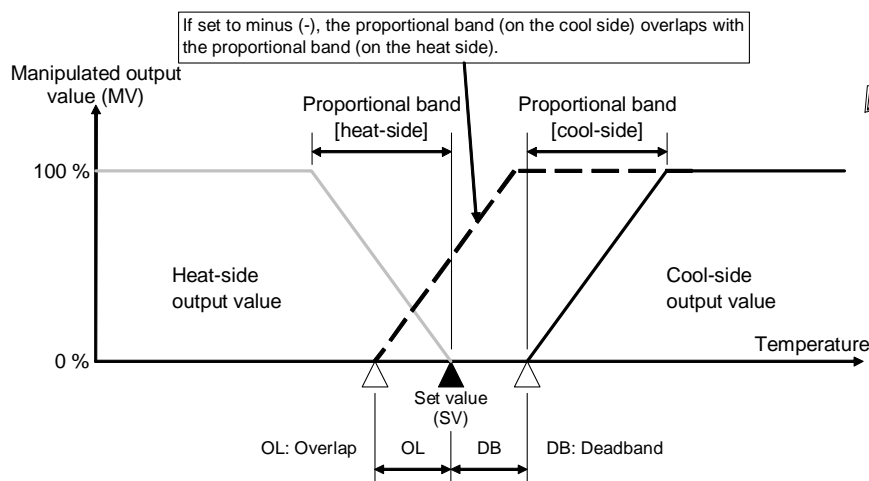

The diagram is an example when setting 0.0 to the Overlap/Deadband reference point. For Overlap/Deadband reference point, refer to P. 7-144.



Manual reset



In order to eliminate the offset occurring in Proportional (P) control, the Manipulated output value is manually corrected.

- When the Manual reset is set to the plus (+) side:
The Manipulated output value under the stable condition increases by the Manual reset value.
- When the Manual reset is set to the minus (-) side:
The Manipulated output value under the stable condition decreases by the Manual reset value.

Data range	Factory set value
-100.0 to +100.0 %	0.0



This screen is displayed when the Integral time [heat-side or cool-side] is turned off.

Related parameters

Parameter setting mode:

- Integral time [heat-side] (P. 7-25)
- Integral time [cool-side] (P. 7-27)

■ Description of function

This is the function used to manually correct the offset when in Proportional (P) control or PD control. Offset means the deviation of the actual when the Manipulated output value becomes stabilized (stable state). If the Manual reset value varies, the Manipulated output value also changes.

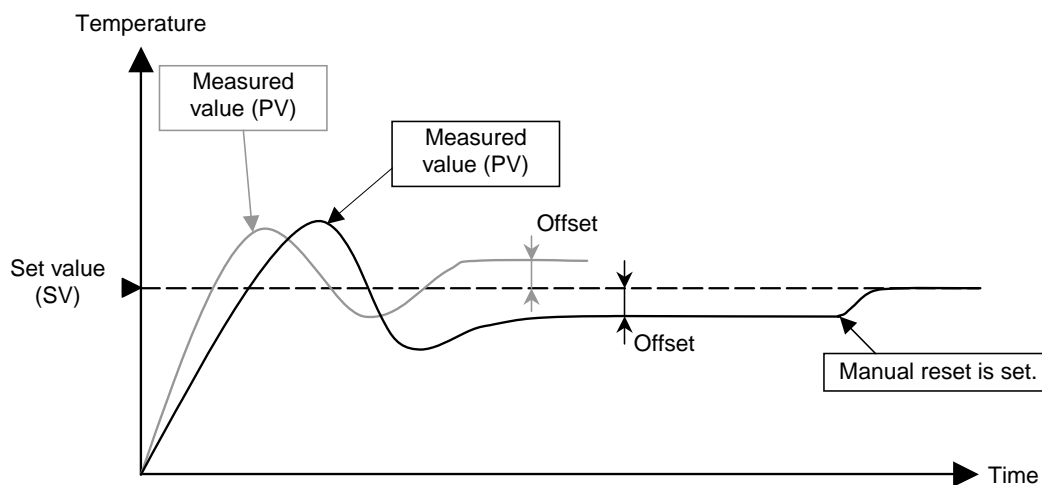

Setting change rate limiter (up)

Setting change rate limiter (down)



SVrU

SVrd

This function is to allow the Set value (SV) to be automatically changed at specific rates when a new Set value (SV).

SVrU is used when the SV is changed to a higher SV.

SVrd is used when the SV is changed to a lower SV.

Data range	Factory set value
1 (0.1, 0.01) to Input span/unit time oFF (oFF): Unused Varies with the setting of the Decimal point position (P. 7-71).	oFF (oFF)

The unit time of the Setting change rate limiter can be change in the range of 1 to 3600 seconds. The unit time is set on the Setting change rate limiter unit time (P. 7-169).

Related parameter

Engineering mode:

- Decimal point position (P. 7-71)
- Setting change rate limiter unit time (P. 7-169)

■ Description of function

This function is to allow the Set value (SV) to be automatically changed at specific rates when a new Set value (SV). SVrU is used when the SV is changed to a higher SV. SVrd is used when the SV is changed to a lower SV.

[Application examples of Setting change rate limiter]

• Increasing the SV to a higher value

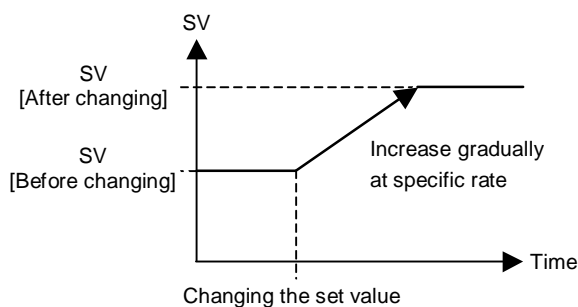

• Decreasing the SV to a lower value

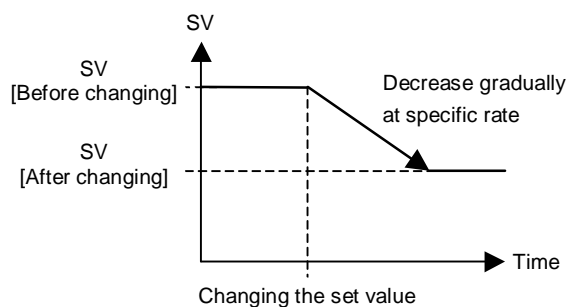

When the Setting change rate limiter is used, the SV will also ramp up or ramp down by the function at power-on and operation mode change from STOP to RUN.

If the Autotuning (AT) function is activated while the SV is ramping up or ramping down by the Setting change rate limiter, AT will starts after the SV finishes ramp-up or ramp-down by the limiter, and the controller is in PID control mode until AT starts.

When the value of Setting change rate limiter is changed during normal operation, the ramp-up or ramp-down rate will be changed unless the SV already has finished ramp-up or ramp-down by the function.

If the rate of Setting change limiter is set to any value other than “OFF (Unused),” the event re-hold action to be taken by a Set value (SV) change becomes invalid.



Area soak time

ASr

This is the time required until transferred to the Link area number when performing Ramp/Soak control.

Data range	Factory set value
0 minutes 00 seconds to 199 minutes 59 seconds	0:00
0 hours 00 minutes to 99 hours 59 minutes	

Data range is selected on the Soak time unit (P. 7-169).

Related parameter

Parameter setting mode:

- Link area number (P. 7-33)

Engineering mode:

- Soak time unit (P. 7-169)

■ Description of function

Area soak time is used for Ramp/Soak control function in conjunction with Link area number and Setting change rate limiter (up/down).

[Application examples of Area soak time]

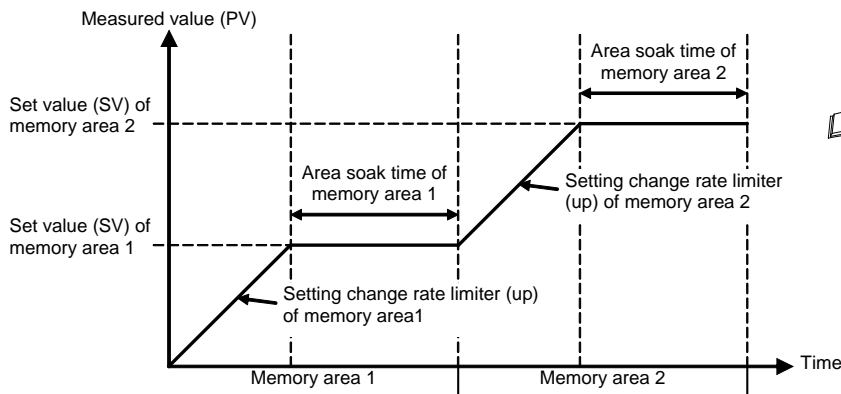

The Area soak time for the memory area linked last becomes invalid to continue the state of the Set value (SV) reached.



Time required while the Setting change rate limiter is being operated is not included in the Area soak time.



The Area soak time can be changed during normal operation with Ramp/Soak control function, but read the following example carefully how the time change affects Ramp/Soak control time. For example, the memory area which has 5-minute soak time is executed. When 3 minutes passed, the Area soak time is changed from 5 minutes to 10 minutes. The remaining time of the currently executed memory area is computed as follows. (The new soak time 10 minutes) – (lapsed time 3 minutes) = (remaining time 7 minutes) The old soak time does not have any effect on remaining time.

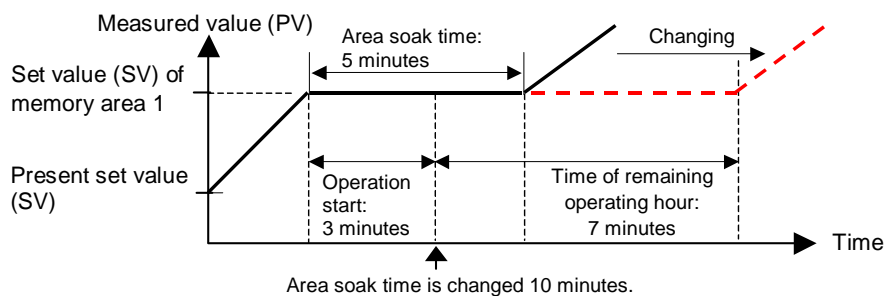

Link area number



LnPA

Memory area numbers for linking the corresponding memory areas are set when Ramp/Soak control is performed.

Data range	Factory set value
1 to 8 oFF (oFF): No link	oFF (oFF)

Related parameter

Parameter setting mode:

- Area soak time (P. 7-32)

Engineering mode:

- Soak time unit (P. 7-169)

■ Description of function

Link area number is used for Ramp/Soak control function in conjunction with Area soak time and Setting change rate limiter (up/down).

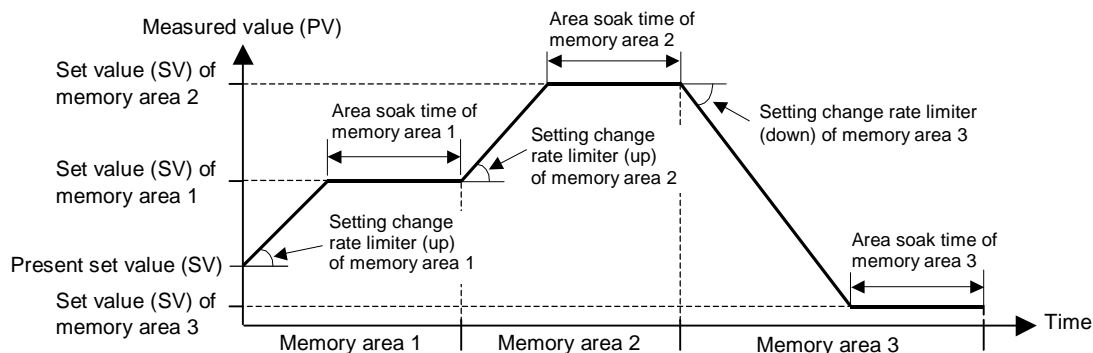

The Area soak time for the memory area linked last becomes invalid to continue the state of the Set value (SV) reached.

7.4 Setup Setting Mode

In Setup setting mode, the following operations are possible.

- Change other operation/control related parameters
- Change Communication parameters
- Change Data lock level

7.4.1 Display sequence

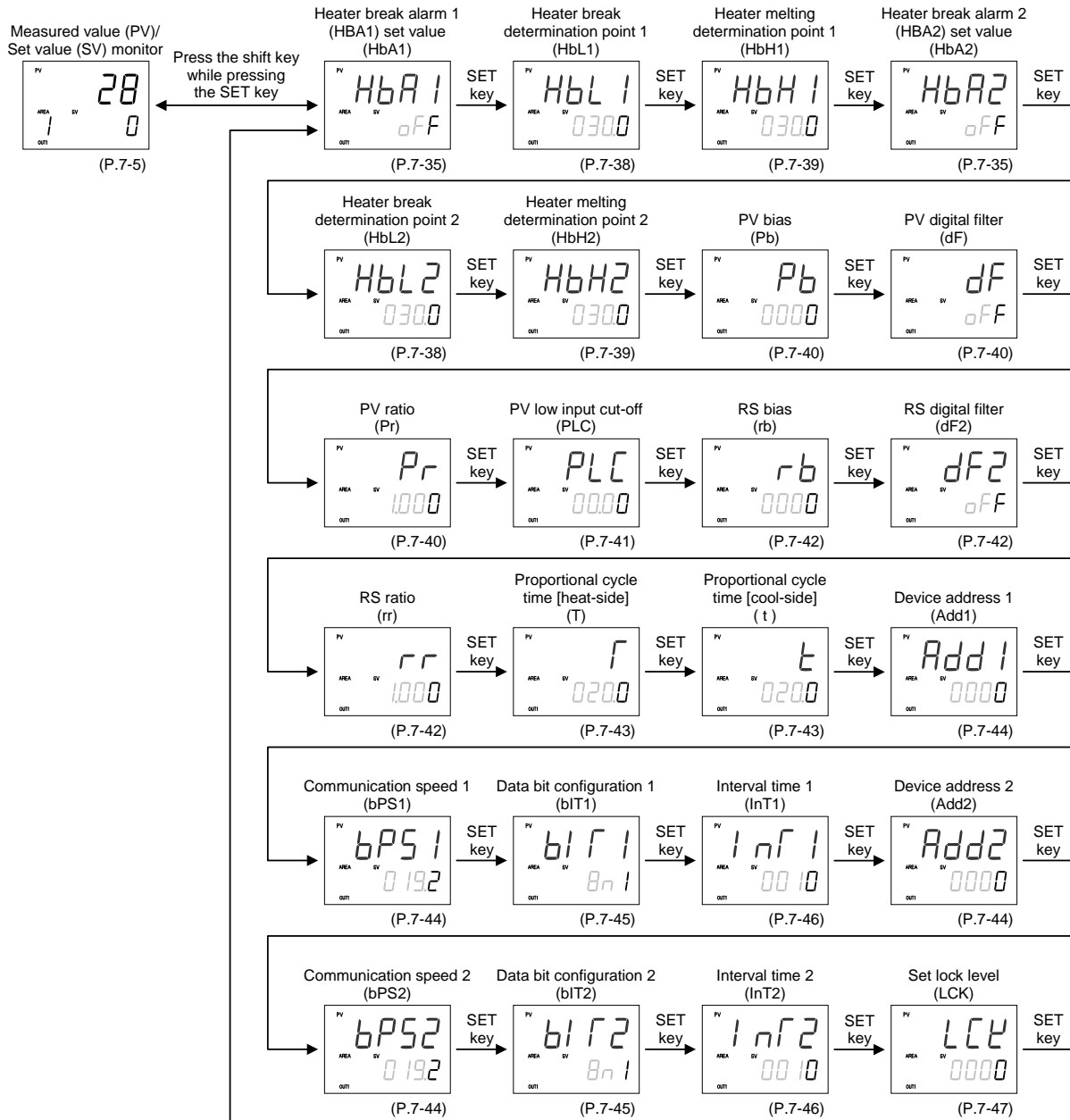

Some parameters may not be displayed when the relevant function is not set so as to be activated or no relevant specification is selected when ordering.



Display returns to the SV setting & monitor mode if no key operation is performed within 1 minute.

7.4.2 Setup setting item

Heater break alarm 1 (HBA1) set value

Heater break alarm 2 (HBA2) set value

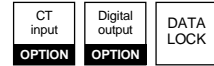

HBA1

HBA2

HBA1 and HBA2 are to set the set values for the Heater break alarm (HBA) function.

Data range	Factory set value
When the CT type is CTL-6-P-N: 0.1 to 30.0 A oFF (oFF): Not used However, the numeric value can be changed up to 100.0.	oFF (oFF)
When the CT type is CTL-12-S56-10L-N: 0.1 to 100.0 A oFF (oFF): Not used	oFF (oFF)

If either Output 2 (OUT2) as an optional or digital output is not selected, no Heater break alarm is output.

These screens are not displayed when the CT assignment is set to “0: None.”

Related parameters

Setup setting mode:

- Heater break determination point 1, Heater break determination point 2 (P. 7-38)
- Heater melting determination point 1, Heater melting determination point 2 (P. 7-39)

Engineering mode:

- Alarm (ALM) lamp lighting condition 2 (P. 7-81)
- Output status at STOP mode (P. 7-82)
- CT1 ratio (P. 7-116)
- CT2 ratio (P. 7-120)
- CT1 assignment (P. 7-117)
- CT2 assignment (P. 7-121)
- Heater break alarm 1 (HBA1) type (P. 7-117)
- Heater break alarm 2 (HBA2) type (P. 7-122)
- Number of heater break alarm 1 (HBA1) delay times (P.7-119)
- Number of heater break alarm 2 (HBA2) delay times (P. 7-122)

■ For the setting of the Heater break alarm

The HBA function detects a fault in the heating circuit by monitoring the current flowing through the load by a dedicated Current transformer (CT). Up to two Heater break alarms are available with the controller. CT input 1 is for HBA1, and CT input 2 for HBA2. CT input can be assigned to one output from OUT1 or OUT2. To use HBA for a three-phase load, both CT inputs can be assigned to the same output.

Continued on the next page.

Continued from the previous page.

Two types of Heater break alarms, type A and type B, are available. An appropriate type should be selected depending on the application. (Please refer to “Heater break alarm function” below.)

These parameters, HBA set values (HbA1 and HbA2) are used for both types. However, each type has different function and care must be used to set an appropriate set value.

For type A HBA,

- Set the set value to approximately 85 % of the maximum reading of the CT input.
- Set the set value to a slightly smaller value to prevent a false alarm if the power supply may become unstable.
- When more than one heater is connected in parallel, it may be necessary to increase the HBA set value to detect a single heater failure.

For type B HBA,

Set the set value to the maximum CT input value. This will be the current when the control is at 100 % control output. The set value is used to compute the width of a non-alarm range.

■ Description of function

< Heater break alarm (HBA) type A >

Heater break alarm (HBA) type A can be used with time-proportional control output (Relay contact, Voltage pulse, Triac or Open collector output). The HBA function monitors the current flowing through the load by a dedicated Current transformer (CT), compares the measured value with the HBA set values, and detects a fault in the heating circuit.

Low or No current flow (Heater break, malfunction of the control device, etc.):

When the control output is ON and the CT input value is equal to or less than the Heater break determination point for the preset number of consecutive sampling cycles, an alarm is activated.

Over current or short-circuit:

When the control output is OFF and the CT input value is equal to or greater than the Heater break determination point for the preset number of consecutive sampling cycles, an alarm is activated.

< Heater break alarm (HBA) type B >

Heater break alarm (HBA) type B can be used with continuous control output (Voltage/Current continuous output). The HBA function assumes that the heater current value is proportional* to the control output value of the controller, otherwise viewed as the Manipulated output value (MV), and compare it with the CT input value to detect a fault in the heating or cooling circuit.

* It is assumed that the current value flowing through the load is at maximum when the control output from the controller is 100 %, and the minimum current value flowing through the load is zero (0) when the control output from the controller is 0 %.

Continued on the next page.

Continued from the previous page.

Low or No current flow (Heater break, malfunction of the control device, etc.)

The alarm determination point (Low) is computed as follows:

$$[\text{Non-alarm range (Low) width}] = (\text{HbL1 or HbL2}) \times (\text{HbA1 or HbA2})$$

$$[\text{Alarm determination point (Low)}] = [(\text{HbA1 or HbA2}) \times (\text{MV1 or MV2})] - [\text{Non-alarm range (Low) width}]$$

When the CT input value is equal to or less than the Heater break determination point for the preset number of consecutive sampling cycles, an alarm status is produced.

Over current or short-circuit

The alarm determination point (High) is computed as follows:

$$[\text{Non-alarm range (High) width}] = (\text{HbH1 or HbH2}) \times (\text{HbA1 or HbA2})$$

$$[\text{Alarm determination point (High)}] = [(\text{HbA1 or HbA2}) \times (\text{MV1 or MV2})] + [\text{Non-alarm range (High) width}]$$

When the CT input value is equal to or greater than the Heater melting determination point for the preset number of consecutive sampling cycles, an alarm status is produced.

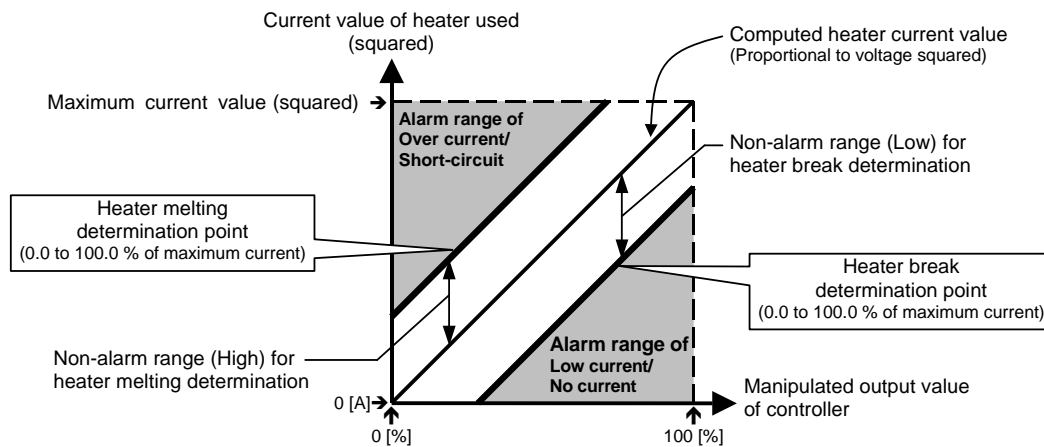

The current factory set values of HbLs and HbHs are set to 30.0 %. If any of the following conditions exists, set them to a slightly larger value to prevent a false alarm.

- **Heater current values is not proportional to the control output in Phase control.**
- **There is difference on control output accuracy between the controller and the operating unit (SCR Power Controller).**
- **There is a delay on control output between the controller and the operating unit (SCR Power Controller).**



Factory set value of Heater break alarm (HBA) varies with the control output type of CT assignment.

- Factory set value (CT assignment: OUT1) of Heater break alarm 1 (HBA1) type:
 - OUT1 output type: Time-proportional control output *: Type A
 - Continuous control output *: Type B
- Factory set value (CT assignment: None) of Heater break alarm 2 (HBA2) type: Type A

* Time-proportional control output: Relay contact, Voltage pulse, Triac or Open collector output
 Continuous control output: Voltage/Current continuous output

Heater break determination point 1

Heater break determination point 2

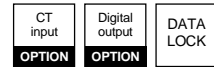

HbL 1

HbL 2

Set the Heater break determination point for the Heater break alarm (HBA) type B.

Data range	Factory set value
Heater break determination point 1: 0.1 to 100.0 % of Heater break alarm 1 (HBA1) set value □FF (oFF): Heater break determination is invalid	30.0
Heater break determination point 2: 0.1 to 100.0 % of Heater break alarm 2 (HBA2) set value □FF (oFF): Heater break determination is invalid	30.0



The Heater break determination point 1 or 2 screen is not displayed when CT assignment is set to “0: None.”



The Heater break determination point 1 or 2 screen is displayed when the Heater break alarm type is type B.

Related parameters

Setup setting mode:

- Heater break alarm 1 (HBA1) set value,
Heater break alarm 2 (HBA2) set value (P. 7-35)
- Heater melting determination point 1,
Heater melting determination point 2 (P. 7-39)

Engineering mode:

- CT1 assignment (P. 7-117)
- CT2 assignment (P. 7-121)
- Heater break alarm 1 (HBA1) type (P. 7-117)
- Heater break alarm 2 (HBA2) type (P. 7-122)
- Number of heater break alarm 1 (HBA1) delay times (P. 7-119)
- Number of heater break alarm 2 (HBA2) delay times (P. 7-122)



For the function description, refer to the **Heater break alarm 1 (HBA1) set value/Heater break alarm 2 (HBA2) set value (P.7-35)**.

Heater melting determination point 1

Heater melting determination point 2

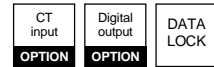



HbH1

HbH2

Set the Heater melting determination point for the Heater break alarm (HBA) type B.

Data range	Factory set value
Heater melting determination point 1: 0.1 to 100.0 % of Heater break alarm 1 (HBA1) set value oFF (oFF): Heater melting determination is invalid	30.0
Heater melting determination point 2: 0.1 to 100.0 % of Heater break alarm 2 (HBA2) set value oFF (oFF): Heater melting determination is invalid	30.0

 The Heater melting determination point 1 or 2 screen is not displayed when CT assignment is set to “0: None.”

 The Heater melting determination point 1 or 2 screen is displayed when the Heater break alarm type is type B.

Related parameters

Setup setting mode:

- Heater break alarm 1 (HBA1) set value, Heater break alarm 2 (HBA2) set value (P. 7-35)
- Heater break determination point 1, Heater break determination point 2 (P. 7-38)

Engineering mode:

- CT1 assignment (P. 7-117)
- CT2 assignment (P. 7-121)
- Heater break alarm 1 (HBA1) type (P. 7-117)
- Heater break alarm 2 (HBA2) type (P. 7-122)
- Number of heater break alarm 1 (HBA1) delay times (P. 7-119)
- Number of heater break alarm 2 (HBA2) delay times (P. 7-122)

 For the function description, refer to the **Heater break alarm 1 (HBA1) set value/Heater break alarm 2 (HBA2) set value (P.7-35)**.

DATA
LOCK**PV bias** P_b

PV bias adds bias to the Measured value (PV). The PV bias is used to compensate the individual variations of the sensors or correct the difference between the Measured value (PV) of other instruments.

Data range	Factory set value
-Input span to +Input span Varies with the setting of the Decimal point position (P. 7-71).	0

Related parameters

Engineering mode:

- Decimal point position (P. 7-71)

DATA
LOCK**PV digital filter** dF

This item is the time of the first-order lag filter to eliminate noise against the measured input.

Data range	Factory set value
0.1 to 100.0 seconds αFF (oFF): Unused	αFF (oFF)

DATA
LOCK**PV ratio** P_r

PV ratio is a multiplier to be applied to the Measured value (PV). The PV ratio is used to compensate the individual variations of the sensors or correct the difference between the Measured value (PV) of other instruments.

Data range	Factory set value
0.500 to 1.500	1.000

PV low input cut-off

DATA
LOCK

PLC

PV low input cut-off is used with Square root extraction function. The Measured value less than the PV low input cut-off is ignored to prevent control disturbance caused by input variation at Low measured value range.

Data range	Factory set value
0.00 to 25.00 % of input span	0.00

 This screen is displayed when the Square root extraction is set to "1: Used."

Related parameter

Engineering mode:

- Square root extraction (P. 7-75)

■ Description of function

When input signal square root extraction is used for in flow control, etc., the Square root extraction result varies widely at the Low measured value range. The Measured value less than the PV low input cut-off is ignored to compute control output in order to prevent control disturbance caused by input variation at Low measured value range.

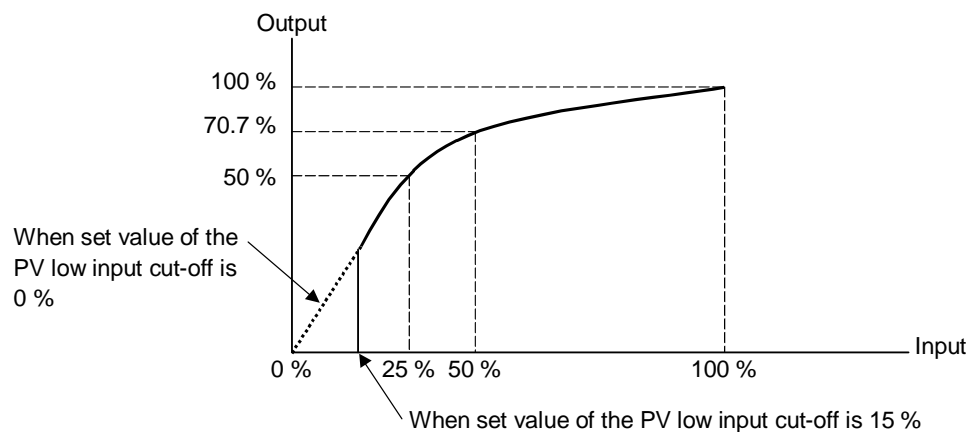



RS bias

DATA
LOCK

rb

RS bias adds bias to the Remote setting (RS) input value.

Data range	Factory set value
-Input span to +Input span Varies with the setting of the Decimal point position (P. 7-71).	0

-  The RS bias screen is displayed when the Remote setting (RS) input is provided.
-  If the Intercontroller communication control, the RS bias is used as a cascade bias.
-  If the Intercontroller communication control, the RS bias is used as a ratio setting bias.

Related parameters

Engineering mode:

- Decimal point position (P. 7-71)



RS digital filter

DATA
LOCK

df2

This item is the time of the first-order lag filter to eliminate noise against the remote setting input.

Data range	Factory set value
0.1 to 100.0 seconds oFF (oFF): Unused	oFF (oFF)

-  The RS digital filter screen is displayed when the Remote setting (RS) input is provided.
-  If the Intercontroller communication control, the RS digital filter is used as a cascade digital filter.
-  If the Intercontroller communication control, the RS digital filter is used as a ratio setting digital filter.



RS ratio

DATA
LOCK

rr

RS ratio is a multiplier to be applied to the Remote setting (RS) input value.

Data range	Factory set value
0.001 to 9.999	1.000

-  The RS ratio screen is displayed when the Remote setting (RS) input is provided.
-  If the Intercontroller communication control, the RS ratio is used as a cascade ratio.
-  If the Intercontroller communication control, the RS ratio is used as a ratio setting ratio.

Proportional cycle time [heat-side]

DATA
LOCK

Proportional cycle time is to set control cycle time for time based control output such as voltage pulse for SSR, triac, relay and open-collector output.

When in Heat/Cool PID control, it becomes the Proportional cycle time on the heat-side.

Data range	Factory set value
0.1 to 100.0 seconds	Relay contact output (M): 20.0
	Voltage pulse output (V), Triac output (T) and Open-collector output (D): 2.0



This screen is not displayed when the output 1 (OUT1) is Voltage/Current output.

Proportional cycle time [cool-side]

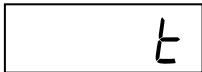
DATA
LOCK

This is a proportional cycle time of cool-side in the Heat/Cool PID control.

Proportional cycle time [cool-side] is to set control cycle time for time based control output such as Voltage pulse for SSR, Triac, Relay contact and Open-collector output.

Data range	Factory set value
0.1 to 100.0 seconds	Relay contact output (M): 20.0
	Voltage pulse output (V), Triac output (T) and Open-collector output (D): 2.0



This screen is displayed when in Heat/Cool PID control.



This screen is not displayed when the output 2 (OUT2) is Voltage/Current output.

Device address 1

Device address 2



Add 1

Add 2

Device address 1: Device address 1 is used to set the slave address of the controller for Communication 1 function.

Device address 2: Device address 2 is used to set the slave address of the controller for Communication 2 function.

Device address 2 is also used for the address setting when the Intercontroller communication function is used.

Data range	Factory set value
0 to 99	0



Do not use the same device address for more than one controller in multi-drop connection. Each controller must have a unique address in multi-drop connection.



When using the Intercontroller communication function, set Device address 2 to any number in the range of 0 to 31.

In addition, always set the address of each controller to the number in succession starting from 0.



In Modbus communication, two-way communication is not possible when the address is 0.



For details of the Intercontroller communication function, refer to **6.14 Group Operation by the Intercontroller Communication (P. 6-60)**.



For details of the communication function, refer to the separate **FB100/FB400/FB900 Communication Instruction Manual (IMR01W04-E□)**.

Communication speed 1

Communication speed 2



bPS 1

bPS 2

Communication speed 1: Communication speed 1 is to set communication speed for Communication 1 function.

Communication speed 2: Communication speed 2 is to set communication speed for Communication 2 function.

Data range	Factory set value
2.4: 2400 bps 9.6: 9600 bps 38.4: 38400 bps	19.2
4.8: 4800 bps 19.2: 19200 bps	



Communication speed 2 screen is not displayed, when the communication 2 protocol is selected to Intercontroller communication protocol (P. 7-168).



For details of the Communication function, refer to the separate **FB100/FB400/FB900 Communication Instruction Manual (IMR01W04-E□)**.

Data bit configuration 1

Data bit configuration 2



6171

Data bit configuration 1:

This item is Data bit configuration of Communication 1 function.

6172

Data bit configuration 2:

This item is Data bit configuration of Communication 2 function.

Set value	Data bit configuration			Modbus Communication	RKC Communication
	Data	Stop	Parity		
8n1	8	1	Without	Selectable	Selectable
8n2	8	2	Without		
8E1	8	1	Even		
8E2	8	2	Even		
8o1	8	1	Odd		
8o2	8	2	Odd		
7n1	7	1	Without	Invalid	
7n2	7	2	Without		
7E1	7	1	Even		
7E2	7	2	Even		
7o1	7	1	Odd		
7o2	7	2	Odd		

Factory set value:

8n1 (Data bit: 8, Stop bit: 1, Parity bit: Without)



Data bit configuration 2 screen is not displayed, when the Communication 2 protocol is selected to Intercontroller communication protocol (P. 7-168).



For details of the Communication function, refer to the separate **FB100/FB400/FB900 Communication Instruction Manual (IMR01W04-E□)**.

Interval time 1

Interval time 2



Interval time 1: This item is Interval time of Communication 1 function.

Interval time 2: This item is Interval time of Communication 2 function.

Data range	Factory set value
0 to 250 ms	10

These screens are not displayed when the Intercontroller communication protocol is selected. (Refer to P. 7-168)

For details of the Communication function, refer to the separate **FB100/ FB400/FB900 Communication Instruction Manual (IMR01W04-E□)**.

Set lock level



The Set lock level restricts parameter setting changes by key operation (Set data lock function).

This function prevents the operation from making errors during operation.

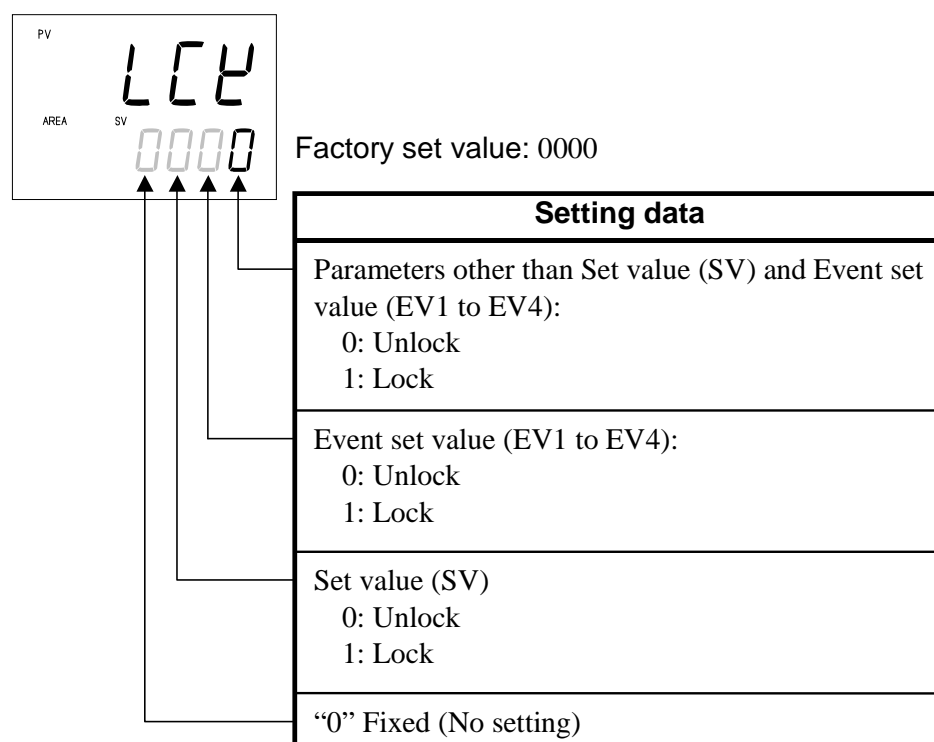

 In the Set lock level, data lock is not possible for following parameters.

- Memory area selection (SV setting & monitor mode),
- Parameter of Function block number F10 to F91 (Engineering mode)

 Set lock level can be changed in both RUN and STOP mode.



 Parameters protected by Data lock function are still displayed for monitoring.

7.5 Engineering Mode

The content relating to the specification of this product is set. Set it so as to meet the customer's requirements. For details of the parameter, refer to the **7.5.3 Engineering item list (P. 7-62)**.

WARNING

Parameters in the Engineering mode should be set according to the application before setting any parameter related to operation. Once the parameters in the Engineering mode are set correctly, no further changes need to be made to parameters for the same application under normal conditions. If they are changed unnecessarily, it may result in malfunction or failure of the instrument. RKC will not bear any responsibility for malfunction or failure as a result of improper changes in the Engineering mode.

-  **Parameters in Engineering mode are settable only when the controller is in STOP mode. However, only checking can be made even in the RUN state.**
-  All parameters of the Engineering mode are displayed regardless of the instrument specification.

7.5.1 Display Sequence

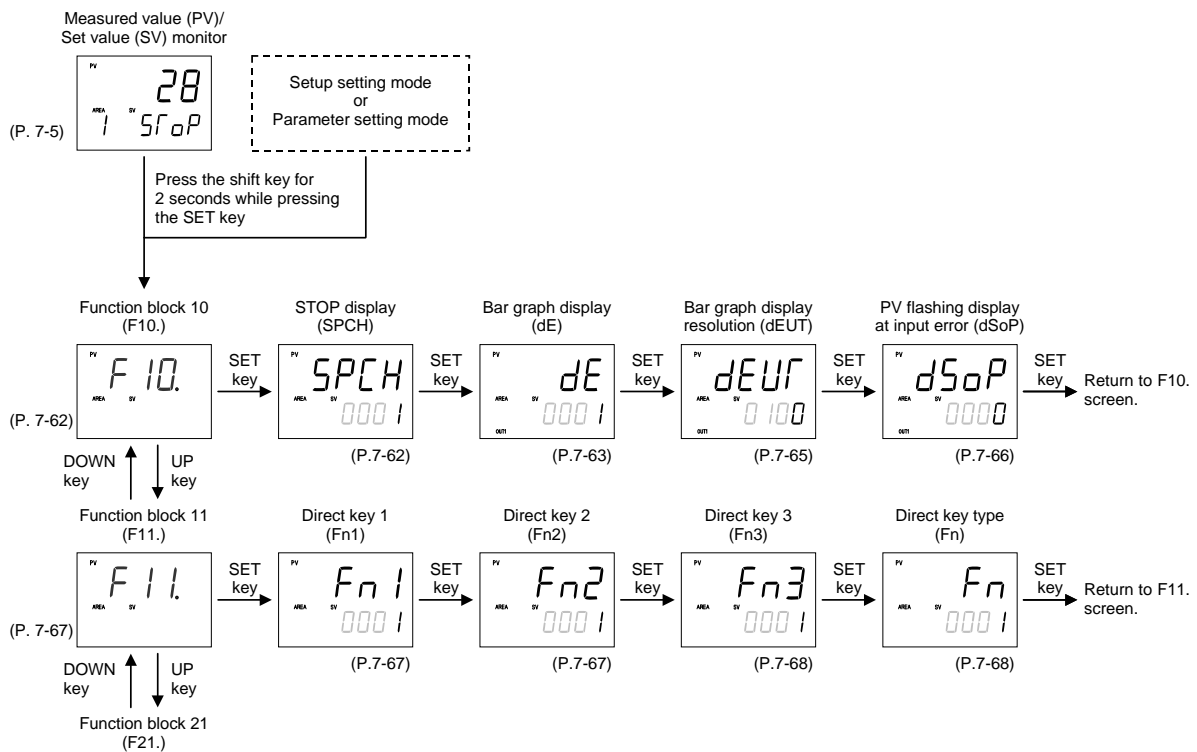

Continued on the next page.

Continued from the previous page.

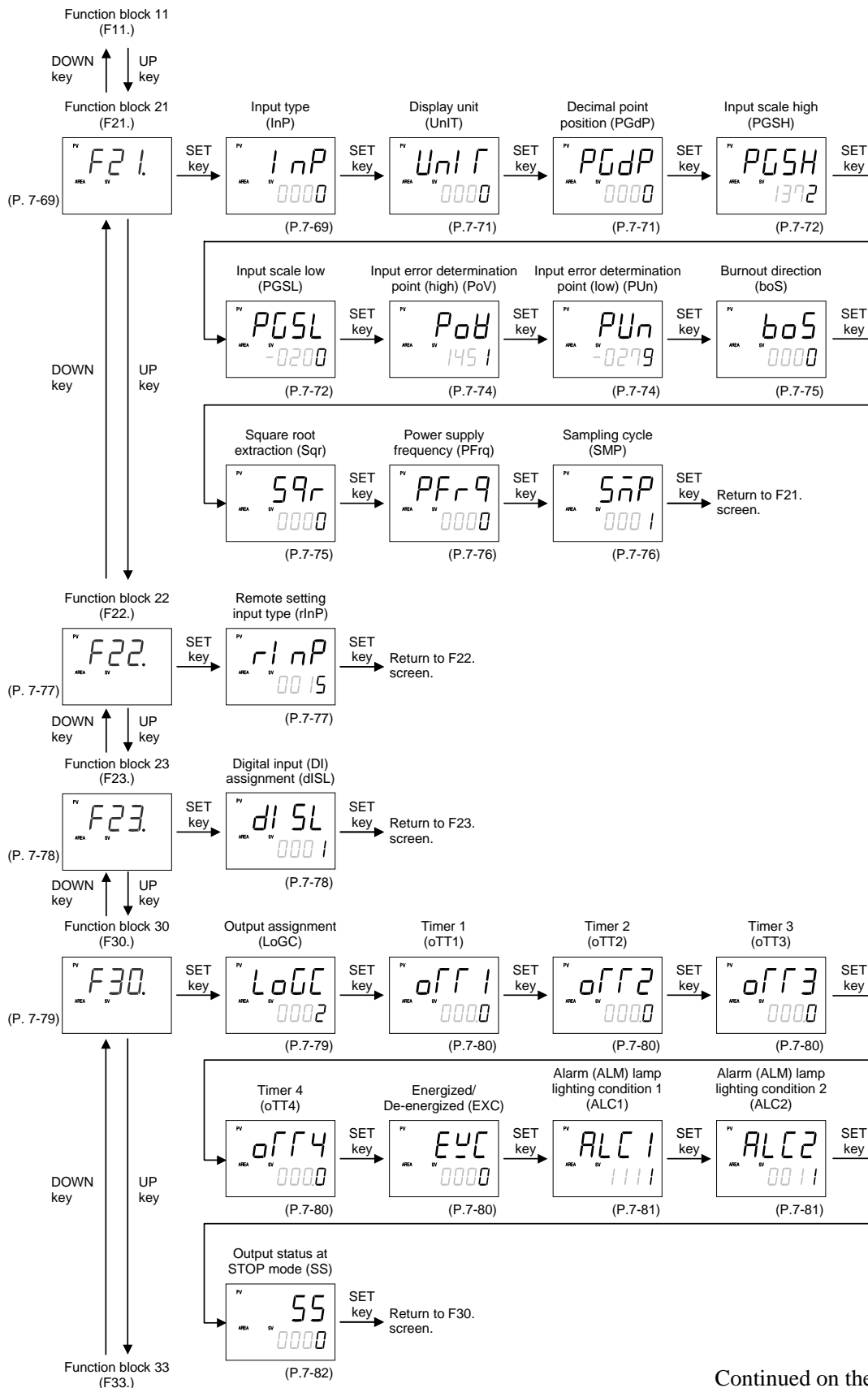

Continued on the next page.

Continued from the previous page.

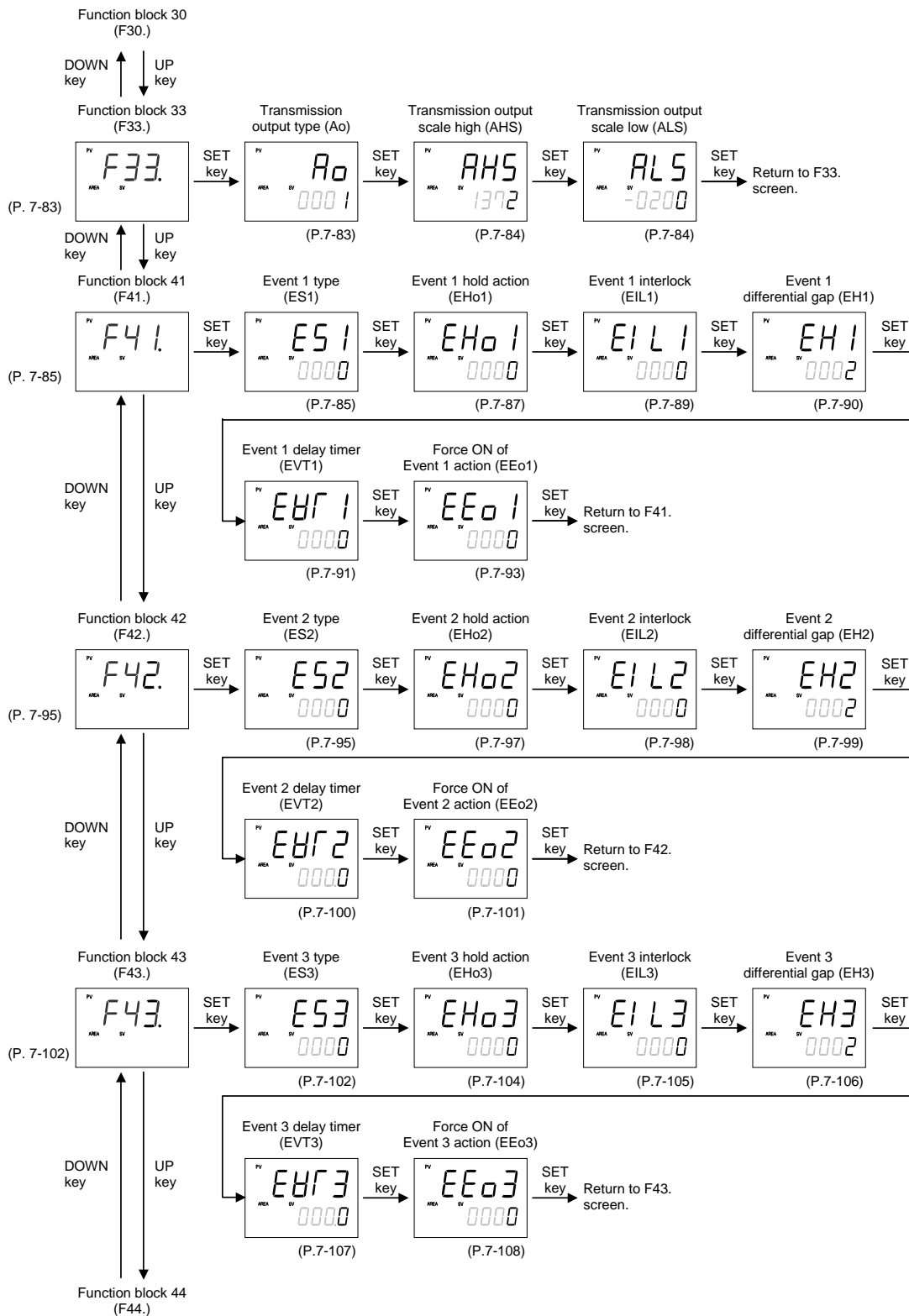

Continued on the next page.

Continued from the previous page.

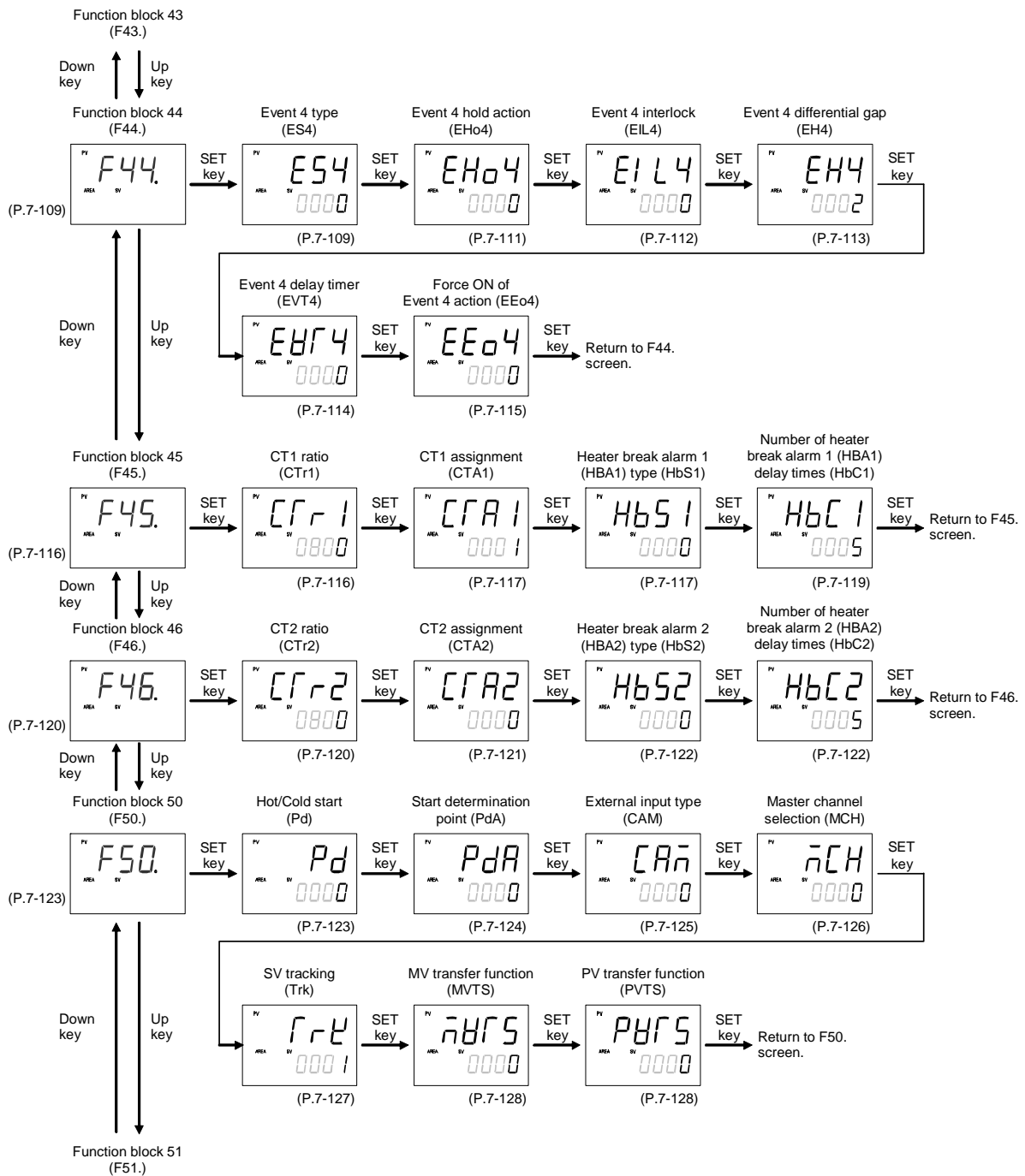

Continued on the next page.

Continued from the previous page.

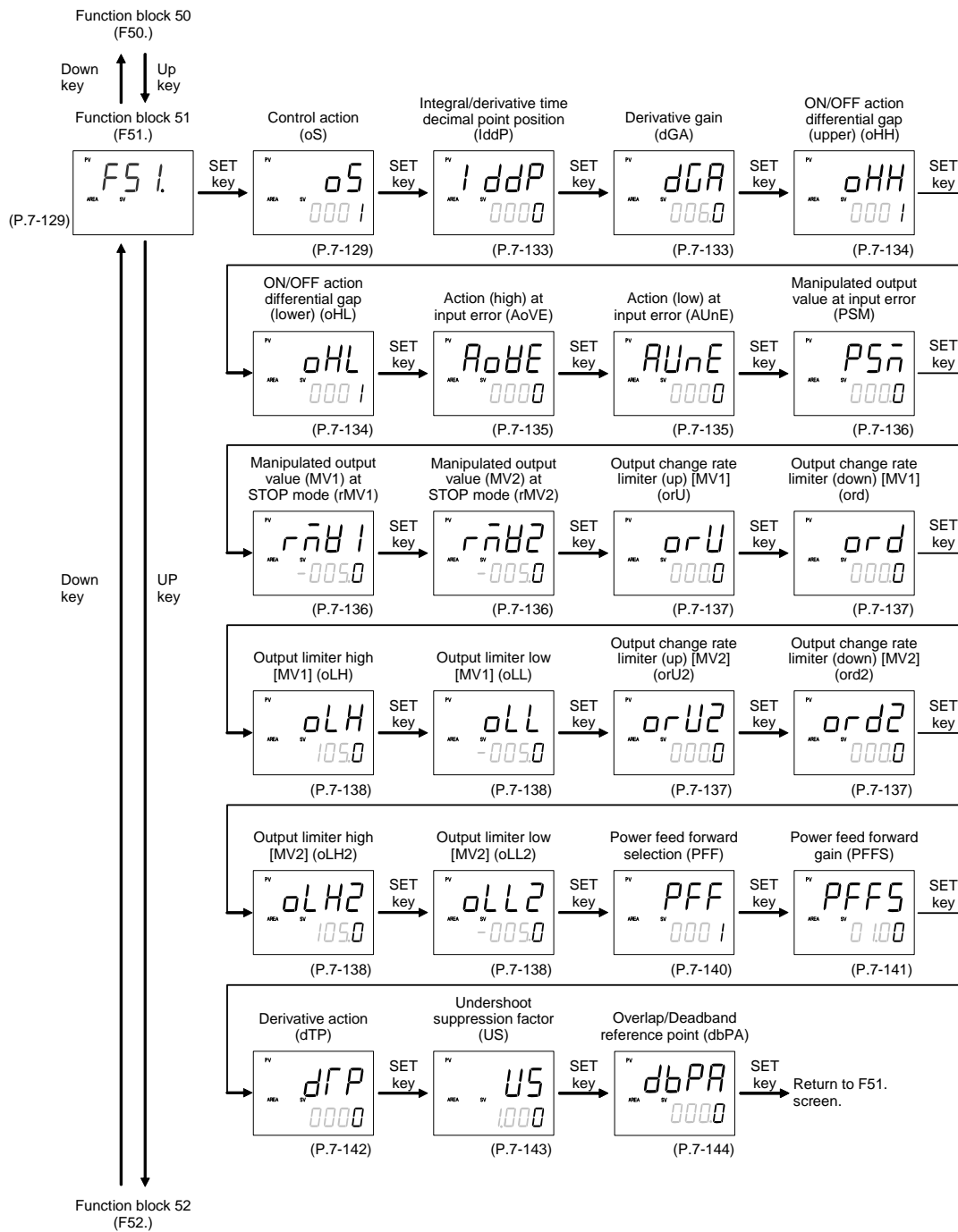

Continued on the next page.

Continued from the previous page.

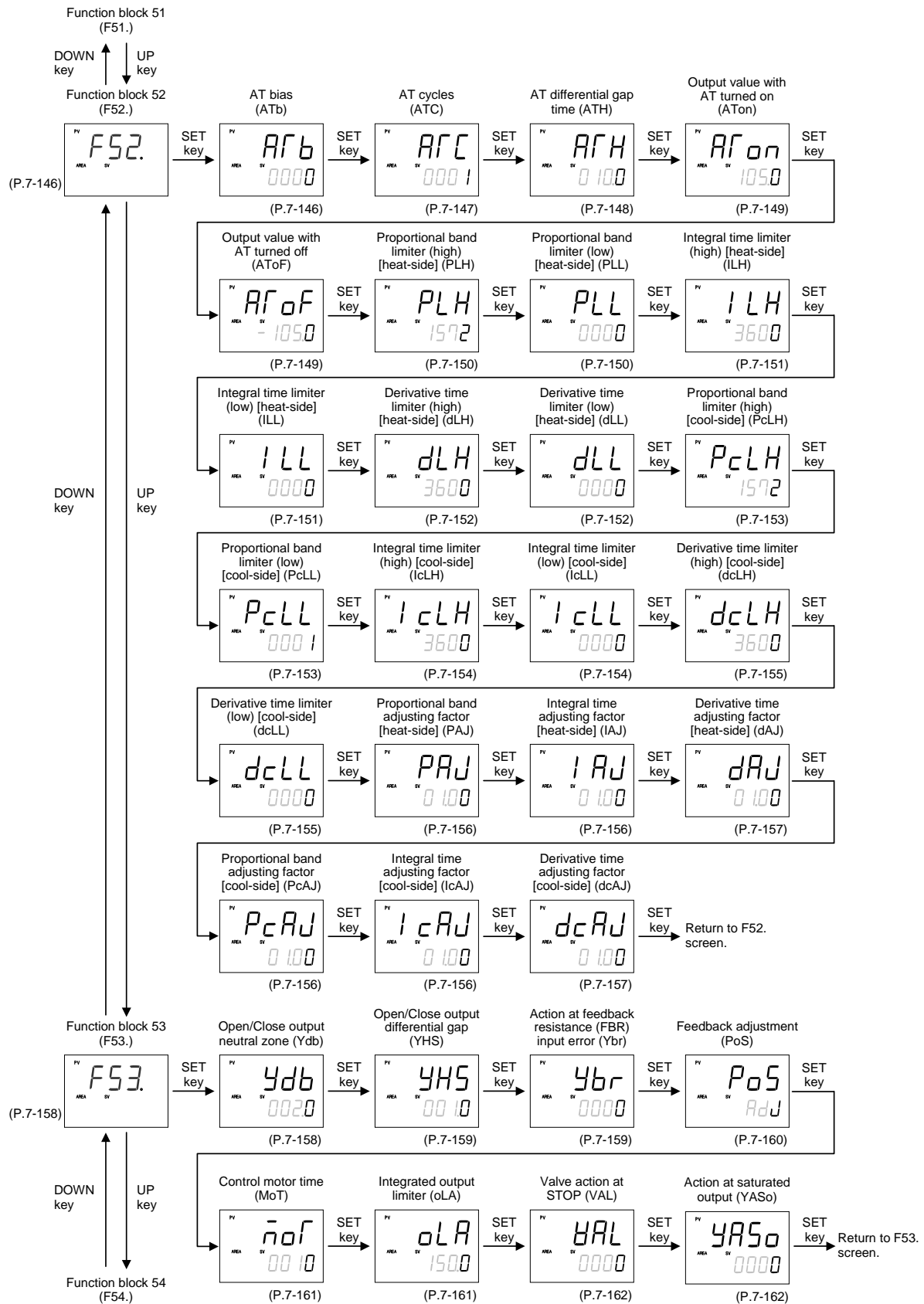

Continued on the next page.

Continued from the previous page.

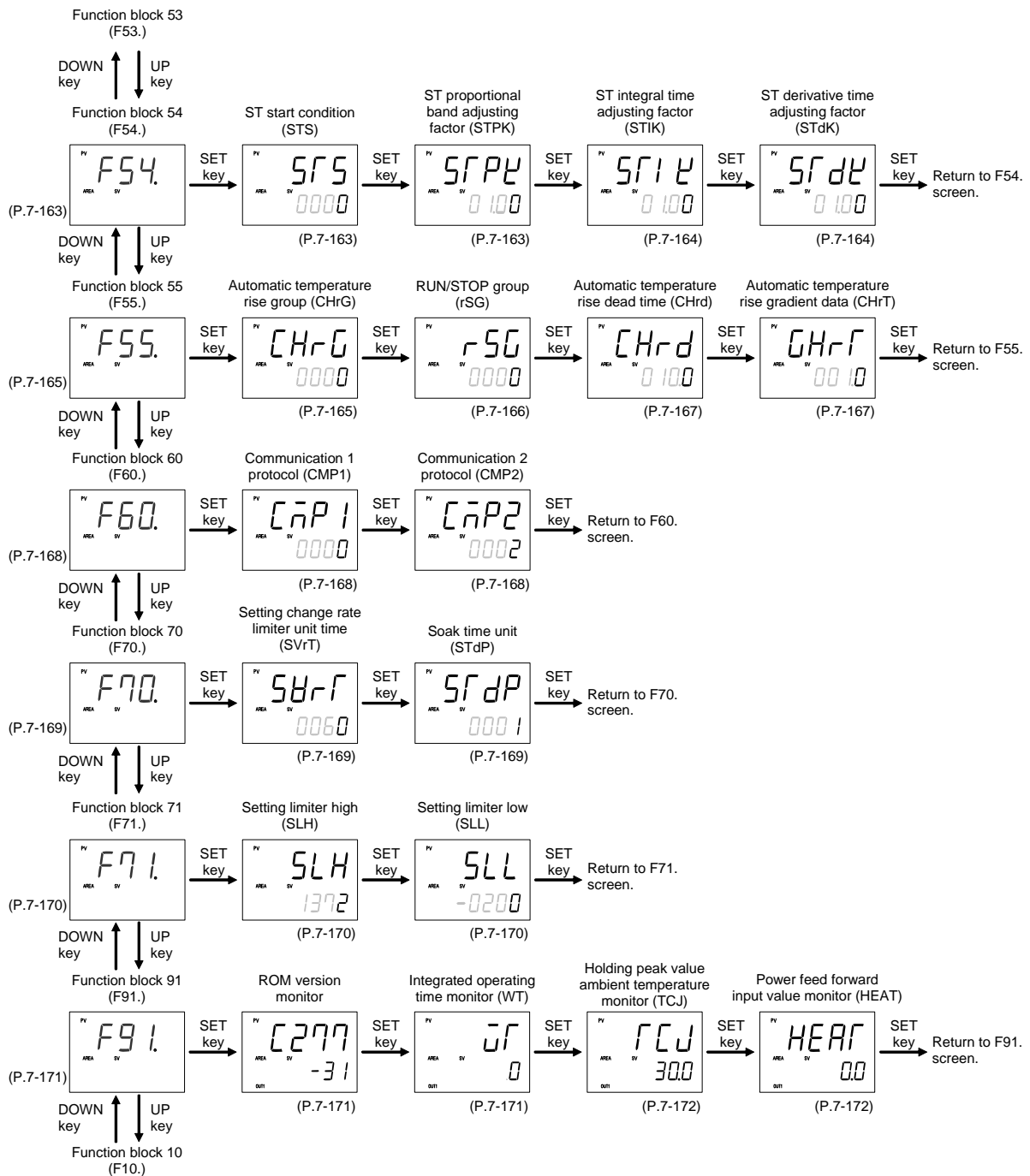

Display returns to the SV setting & monitor mode if no key operation is performed within 1 minute (except during the Feedback adjustment or the Power feed forward input value monitor display).



To return to the SV setting & monitor mode, press the shift key while pressing the SET key.

7.5.2 Precaution against parameter change

If any of the following parameters is changed, the set values of relevant parameters are initialized or is automatically converted according to the new setting. It may result in malfunction or failure of the instrument.

- Input type (InP) or Display unit (UnIT)
- Transmission output type (Ao)
- Event 1 type (ES1), Event 2 type (ES2), Event 3 type (ES3) or Event 4 type (ES4)
- Control action (oS)
- Decimal point position (PGdP)
- Integral/Derivative time decimal point position (IddP)
- CT1 assignment (CTA1) or CT2 assignment (CTA2)



Before changing any parameter setting on the above list, always record all parameter settings in SV setting & monitor mode, Setup setting mode, Parameter setting mode and Engineering mode. And after the change, always check all parameter settings in SV setting & monitor mode, Setup setting mode, Parameter setting mode and Engineering mode by comparing them with the record taken before the change.

- When any one of the following parameters' settings are changed,

- Input type (InP)
- Display unit (UnIT)

all parameter settings shown in the table below will be changed to Factory default values according to the new setting. They must be changed according to the application.

Mode	Description	Default value
Engineering mode	Decimal point position	TC/RTD inputs: 0 Voltage (V)/Current (I) inputs: 1
	Input scale high	TC/RTD inputs: Maximum value of the selected input range Voltage (V)/Current (I) inputs: 100.0
	Input scale low	TC/RTD inputs: Minimum value of the selected input range Voltage (V)/Current (I) inputs: 0.0
	Input error determination point (high)	TC/RTD inputs: Input scale high + (5 % of input span) Voltage (V)/Current (I) inputs: +105.0
	Input error determination point (low)	TC/RTD inputs: Input scale low – (5 % of input span) Voltage (V)/Current (I) inputs: –5.0
	Burnout direction	0: Upscale
	Transmission output scale high	PV, Set value (SV) monitor, Set value (SV) or RS input value: Input scale high Manipulated output value (MV1 or MV2): 100.0 % Deviation: +Input span
	Transmission output scale low	PV, Set value (SV) monitor, Set value (SV) or RS input value: Input scale low Manipulated output value (MV1 or MV2): 0.0 % Deviation: –Input span
	Event 1 hold action	0 (Without hold action)
	Event 2 hold action	
	Event 3 hold action	
	Event 4 hold action	
	Event 1 interlock	0 (Unused)
	Event 2 interlock	
Event 3 interlock		
Event 4 interlock		

Continued on the next page.

Continued from the previous page.

Mode	Description	Default value
Engineering mode	Event 1 differential gap	TC/RTD inputs: 2 °C [°F]
	Event 2 differential gap	Voltage (V)/Current (I) inputs: 0.2 % of input span
	Event 3 differential gap	Manipulated output value: 0.2 %
	Event 4 differential gap	
	Event 1 delay timer	0.0 seconds
	Event 2 delay timer	
	Event 3 delay timer	
	Event 4 delay timer	
	Force ON of Event 1 action	0000
	Force ON of Event 2 action	
	Force ON of Event 3 action	
	Force ON of Event 4 action	
	Start determination point	3 % of input span
	ON/OFF action differential gap (upper)	TC/RTD inputs: 1 °C [°F]
	ON/OFF action differential gap (lower)	Voltage (V)/Current (I) inputs: 0.1 % of input span
	AT bias	0
	Proportional band limiter (high) [heat-side]	TC/RTD inputs: Input span Voltage (V)/Current (I) inputs: 1000.0 %
	Proportional band limiter (low) [heat-side]	TC/RTD inputs: 0 °C [°F] Voltage (V)/Current (I) inputs: 0.0 %
	Integral time limiter (high) [heat-side]	1 second setting (No decimal place): 3600 seconds 0.1 seconds setting (One decimal place): 1999.9 seconds
	Integral time limiter (low) [heat-side]	1 second setting (No decimal place): 0 seconds 0.1 seconds setting (One decimal place): 0.0 seconds
	Derivative time limiter (high) [heat-side]	1 second setting (No decimal place): 3600 seconds 0.1 seconds setting (One decimal place): 999.9 seconds
	Derivative time limiter (low) [heat-side]	1 second setting (No decimal place): 0 seconds 0.1 seconds setting (One decimal place): 0.0 seconds
	Proportional band limiter (high) [cool-side]	TC/RTD inputs: Input span Voltage (V)/Current (I) inputs: 1000.0 %
	Proportional band limiter (low) [cool-side]	TC/RTD inputs: 1 °C [°F] Voltage (V)/Current (I) inputs: 0.1 %
	Integral time limiter (high) [cool-side]	1 second setting (No decimal place): 3600 seconds 0.1 seconds setting (One decimal place): 1999.9 seconds
	Integral time limiter (low) [cool-side]	1 second setting (No decimal place): 0 seconds 0.1 seconds setting (One decimal place): 0.0 seconds
	Derivative time limiter (high) [cool-side]	1 second setting (No decimal place): 3600 seconds 0.1 seconds setting (One decimal place): 1999.9 seconds
	Derivative time limiter (low) [cool-side]	1 second setting (No decimal place): 0 seconds 0.1 seconds setting (One decimal place): 0.0 seconds
	Setting limiter high	Input scale high
	Setting limiter low	Input scale low
Setup setting mode	PV bias	0
	PV ratio	1.000
Parameter setting mode	Event 1 set value (EV1)	50 °C [°F]
	Event 2 set value (EV2)	
	Event 3 set value (EV3)	
	Event 4 set value (EV4)	

Continued on the next page.

Continued from the previous page.

Mode	Description	Default value
Parameter setting mode	Control loop break alarm (LBA) time	480 seconds
	LBA deadband	0
	Proportional band [heat-side]	TC/RTD inputs: 30 °C [°F] Voltage (V)/Current (I) inputs: 30.0
	Integral time [heat-side]	240 seconds
	Derivative time [heat-side]	60 seconds
	Control response parameter	PID control, Position proportioning PID control: 0 (Slow) Heat/Cool PID control: 2 (Fast)
	Proportional band [cool-side]	TC/RTD inputs: 30 °C [°F] Voltage (V)/Current (I) inputs: 30.0
	Integral time [cool-side]	240 seconds
	Derivative time [cool-side]	60 seconds
	Overlap/Deadband	TC/RTD inputs: 0 °C [°F] Voltage (V)/Current (I) inputs: 0.0 %
	Setting change rate limiter (up)	oFF: Unused
Setting change rate limiter (down)	oFF: Unused	
SV setting & Monitor mode	Set value (SV)	TC/RTD inputs: 0 °C [°F] Voltage (V)/Current (I) inputs: 0.0 %

■ When the following parameter setting is changed,

- **Transmission output type (Ao)**

all parameter settings shown in the table below will be changed to Factory default values according to the new setting. They must be changed according to the application.

Mode	Description	Default value
Engineering mode	Transmission output scale high	PV, Set value (SV) monitor, Set value (SV) or RS input value: Input scale high Manipulated output value (MV1 or MV2): 100.0 % Deviation: +Input span
	Transmission output scale low	PV, Set value (SV) monitor, Set value (SV) or RS input value: Input scale low Manipulated output value (MV1 or MV2): 0.0 % Deviation: -Input span

■ When any one of the following parameters' setting are changed,

- **Event 1 type (ES1)** - **Event 3 type (ES3)**

- **Event 2 type (ES2)** - **Event 4 type (ES4)**

all parameter settings shown in the table below will be changed to Factory default values according to the new setting. They must be changed according to the application.

Mode	Description	Default value
Engineering mode	Event 1 hold action	0 (Without hold action)
	Event 2 hold action	
	Event 3 hold action	
	Event 4 hold action	

Continued on the next page.

Mode	Description	Default value
Engineering mode	Event 1 interlock	0 (Unused)
	Event 2 interlock	
	Event 3 interlock	
	Event 4 interlock	
	Event 1 differential gap	TC/RTD inputs: 2 °C [°F] Voltage (V)/Current (I) inputs: 0.2 % of input span Manipulated output value: 0.2 %
	Event 2 differential gap	
	Event 3 differential gap	
	Event 4 differential gap	
	Event 1 delay timer	0.0 seconds
	Event 2 delay timer	
	Event 3 delay timer	
	Event 4 delay timer	
	Force ON of Event 1 action	0000
	Force ON of Event 2 action	
Force ON of Event 3 action		
Force ON of Event 4 action		
Parameter setting mode	Event 1 set value (EV1)	50 °C [°F]
	Event 2 set value (EV2)	
	Event 3 set value (EV3)	
	Event 4 set value (EV4)	
	Control loop break alarm (LBA) time	480 seconds
	LBA deadband	0

■ When the following parameter setting is changed,

- **Control action (oS)**

all parameter settings shown in the table below will be changed to Factory default values according to the new setting. They must be changed according to the application.

Mode	Description	Default value
Engineering mode	Undershoot suppression factor	PID control (direct action): 1.000
		PID control (reverse action): 1.000
		Heat/Cool PID control [water cooling]: 0.100
		Heat/Cool PID control [air cooling]: 0.250
		Heat/Cool PID control [Cooling gain linear type]: 1.000
		Position proportioning PID control (reverse action): 1.000
		Position proportioning PID control (direct action): 1.000
Parameter setting mode	Control response parameter	PID control, Position proportioning PID control: 0 (Slow)
		Heat/Cool PID control: 2 (Fast)

- When the following parameter setting is changed,

- **Decimal point position (PGdP)**

all parameter settings shown in the table below will be automatically converted into the a values to match the new decimal point position as long as the converted values are in the acceptable range of each parameter. They must be check and changed if necessary according to the application.

Mode	Description
Engineering mode	Input scale high
	Input scale low
	Input error determination point (high)
	Input error determination point (low)
	Transmission output scale high ¹
	Transmission output scale low ¹
	Event 1 differential gap ²
	Event 2 differential gap ²
	Event 3 differential gap ²
	Event 4 differential gap ²
	Start determination point
	ON/OFF action differential gap (upper) ³
	ON/OFF action differential gap (lower) ³
	AT bias
	Proportional band limiter (high) [heat-side] ³
	Proportional band limiter (low) [heat-side] ³
	Proportional band limiter (high) [cool-side] ³
	Proportional band limiter (low) [cool-side] ³
	Setting limiter high
	Setting limiter low
Setup setting mode	PV bias
	RS bias
Parameter setting mode	Event 1 set value (EV1) ²
	Event 2 set value (EV2) ²
	Event 3 set value (EV3) ²
	Event 4 set value (EV4) ²
	LBA deadband
	Proportional band [heat-side] ³
	Proportional band [cool-side] ³
	Overlap/Deadband ³
	Setting change rate limiter (up)
	Setting change rate limiter (down)
	SV setting & Monitor mode
Set value (SV) monitor	
Set value (SV)	
Remote setting (RS) input value	

¹ Only for Measured value (PV), Set value (SV) monitor, Set value (SV) or Remote setting (RS) input value

² Only for deviation, input value or set value

³ Only for thermocouple (TC) or RTD inputs

Precaution and Example of automatic conversion

- Decimal point position moves in accordance with the setting change.

Example: When the setting of the Decimal point position is changed from 0 (no decimal place) to 1 (one decimal place) with Input scale high (PGSH) set to 800 °C:



The display will change from 800 to 800.0.

- If the position of the decimal point is set to any digit exceeding the input range, limited the maximum or minimum value of each input type.

Example: When RTD input is selected for Input type (InP), and Input scale low (PGSL) is -200 °C, the Decimal point position is changed from 1 to 2:

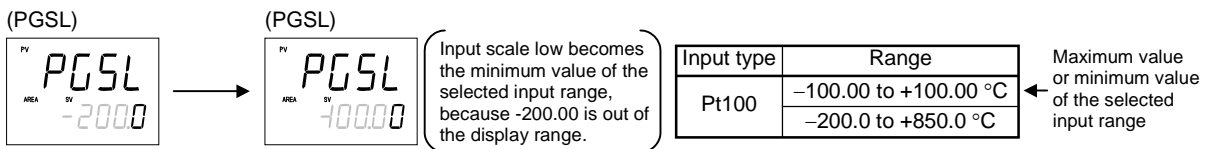

- When a number of decimal places for the set value is reduced due to the decimal point change, the set value is rounded off to the first decimal place and will be displayed without any decimal place.

Example: When the Decimal point position is changed from 1 (one decimal places) to 0 (no decimal place) and Input scale high (PGSH) is 849.9:

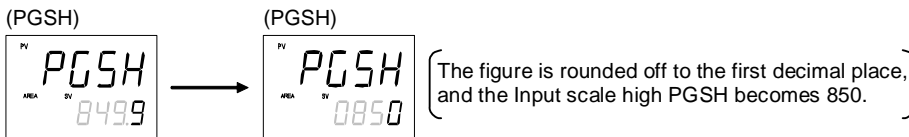

- When the following parameter setting is changed,

- **Integral/Derivative time decimal point position (IddP)**

all parameter settings shown in the table below will be automatically converted into the a values to match the new decimal point position as long as the converted values are in the acceptable range of each parameter. They must be check and changed if necessary according to the application.

Mode	Description
Engineering mode	Integral time limiter (high) [heat-side]
	Integral time limiter (low) [heat-side]
	Derivative time limiter (high) [heat-side]
	Derivative time limiter (low) [heat-side]
	Integral time limiter (high) [cool-side]
	Integral time limiter (low) [cool-side]
	Derivative time limiter (high) [cool-side]
	Derivative time limiter (low) [cool-side]
Parameter setting mode	Integral time [heat-side]
	Derivative time [heat-side]
	Integral time [cool-side]
	Derivative time [cool-side]

7.5.3 Engineering setting item

Function block 10 (F10.)

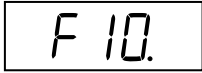

This is the first parameter symbol of Function block 10 (F10.).

F10. STOP display



STOP message for control STOP mode can be displayed either on the upper display or the lower display.

SPCH is to select the display to show the STOP message.

Data range	Factory set value
0: Displays on the Measured value (PV) unit 1: Displays on the Set value (SV) unit	1

■ Description of function

There are four different Characters for STOP mode depending on how to be transferred from RUN to STOP.

The SToP is displayed on the SV display.	(SToP)	(KSTP)	(dSTP)	(GSTP)	When the control was stopped, the Measured value (PV) can be checked.
The SToP is displayed on the PV display.	(SToP)	(KSTP)	(dSTP)	(GSTP)	When the control was stopped, the Set value (SV) can be checked.

For the differences in the STOP (control stop) state, refer to **6.14.3 Group RUN/STOP function (P. 6-63)**.

F10.

Bar graph display

CT input
OPTION



Use to select the contents of the bar graph display.

Data range	Factory set value
0: No display 1: Manipulated output value (MV) 2: Measured value (PV) 3: Set value (SV) monitor 4: Deviation value 5: Current transformer 1 (CT1) input value 6: Current transformer 2 (CT2) input value	1

Number of display dots

- FB400: 10 dots
- FB900: 20 dots

Related parameter

Engineering mode:

- Bar graph display resolution (P. 7-65)

■ Description of function

Bar graph display explanation:

(1) Manipulated output value (MV)

Displays the Manipulated output value (MV). When Manipulated output value (MV) is at 0 % or less, the left-end dot of the bar-graph flashes. When MV exceeds 100 %, the right-end dot flashes.

[Display example]



When the control action is the Heat/Cool PID control:

When both of 'OUT1' and 'OUT2' are lit (when overlapped), the bar graph displays the Manipulated output value (MV1) [heat-side].



When the control action is the Position proportioning PID control:

[With FBR input]

Displays the FBR input value (0.0 to 100.0 %).

[Without FBR input]

Cannot be used as a bar graph. The bar graph displays the over-scaled state (an output of more than 100 %).

[Display example]

In this case, it is recommended to be set to "0: No display."

(2) Measured value (PV)

Displays the Measured value (PV). Scaling is available within the input range.



(3) Set value (SV) monitor

Displays the Set value (SV). Scaling is available within the input range.

Displays the remote set value when the Operation mode is remote mode.



(4) Deviation value

Displays the deviation between the Measured value (PV) and the Set value (SV).

When the Deviation display is selected, the dots at both ends of bar-graph light.

A display resolution per dot is settable from 1 to 100.

The display resolution can be set in the Bar graph display resolution (dEUT). (Refer to P. 7-65)



(5) Current transformer 1 (CT1) input value or Current transformer 2 (CT2) input value

Displays the input value (current value) of CT1 or CT2.

A display resolution per dot is settable from 1 to 100.

The display resolution can be set in the Bar graph display resolution (dEUT). (Refer to P. 7-65)



F10.

Bar graph display resolution



Use to set the bar graph display resolution for the deviation, Current transformer 1 (CT1) or Current transformer 2 (CT2) display. Set several digits per 1 dot of the bar graph.

Data range	Factory set value
1 to 100 digit/dot	100

Related parameter

Engineering mode:

- Bar graph display (P. 7-63)

■ Display resolution setting example of Deviation value

Condition: Controller: FB900

Bar graph display resolution setting: 10 digit/dot

- When the input range is the 1 °C [°F] unit

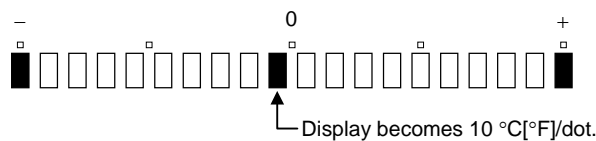

- When the input range is the 0.1 °C [°F] unit

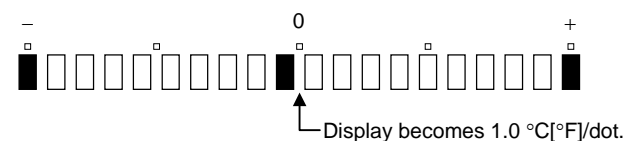

■ Display resolution setting example of CT1

Condition: Current transformer type: CTL-6-P-N (0.0 to 30.0 A)

Controller: FB900

Bar graph display resolution setting: 100 digit/dot

Bar graph display range becomes 0.0 to 30.0 A.

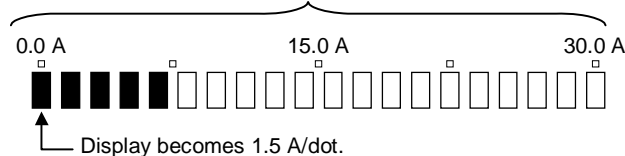

Display resolution and Bar graph display range

Current transformer type	Bar graph resolution setting		
	1 digit/dot	10 digit/dot	100 digit/dot
CTL-6-P-N (0.0 to 30.0 A)	Per 1 dot: FB400: 0.03 A/dot FB900: 0.015 A/dot Bar graph display range: 0.0 to 0.3 A	Per 1 dot: FB400: 0.3 A/dot FB900: 0.15 A/dot Bar graph display range: 0.0 to 3.0 A	Per 1 dot: FB400: 3.0 A/dot FB900: 1.5 A/dot Bar graph display range: 0.0 to 30.0 A
CTL-12-S56-10L-N (0.0 to 100.0 A)	FB400: 0.1 A/dot FB900: 0.05 A/dot Bar graph display range: 0.0 to 1.0 A	FB400: 1.0 A/dot FB900: 0.5 A/dot Bar graph display range: 0.0 to 10.0 A	FB400: 10.0 A/dot FB900: 5.0 A/dot Bar graph display range: 0.0 to 100.0 A

F10.

PV flashing display at input error

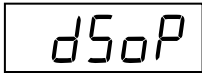

It can be so set that the PV display does not flash if not required. The Measured value (PV) of this instrument flashes in the range of an “5 % of input span” if exceeding the input range.

Data range	Factory set value
0: Flashing display	0
1: Non-flashing display	

■ **Example: When set to non-flashing display in the range of -200.0 to +800.0 °C**

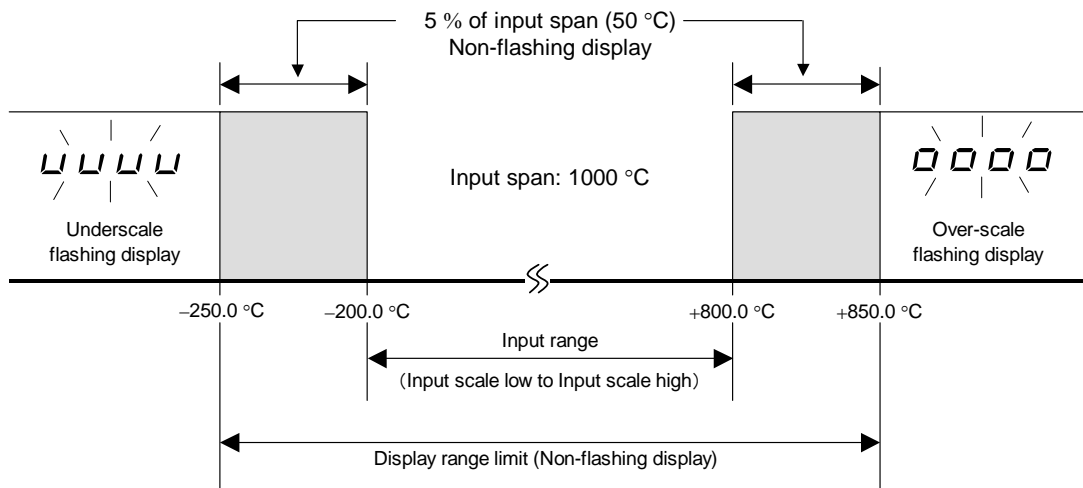

However, if the Input error determination point (low) or the Input error determination point (high) is set within the input range, up to ±5 % of input span from the Input error determination point (low) or (high) becomes the PV flashing display range.

Function block 11 (F11.)

F11

This is the first parameter symbol of Function block 11 (F11.)

F11.

Direct key 1

Fn1

Use to select Use/Unuse of Direct key 1.

The Direct key 1 can be used as an A/M transfer key.

Data range	Factory set value
0: Unused 1: A/M transfer key	1

Related parameter

Engineering mode:

- Direct key type (P. 7-68)

F11.

Direct key 2

Fn2

Use to select Use/Unuse of Direct key 2.

The usage of Direct key 2 is different depending on the Direct key type (Fn).

- When the Direct key type (Fn) is the Type 1: MONI key
- When the Direct key type (Fn) is the Type 2: R/L transfer key

Data range	Factory set value
0: Unused 1: MONI key (For Type 1) or R/L transfer key (For Type 2)	1

Related parameter

Engineering mode:

- Direct key type (P. 7-68)

F11.

Direct key 3

Fn3

Use to select Use/Unuse of Direct key 3.

The usage of Direct key 3 is different depending on the Direct key type (Fn).

- When the Direct key type (Fn) is the Type 1: AREA key
- When the Direct key type (Fn) is the Type 2: R/S transfer key

Data range	Factory set value
0: Unused 1: AREA key (For Type 1) or R/S transfer key (For Type 2)	1

Related parameter

Engineering mode:

- Direct key type (P. 7-68)

F11.

Direct key type

Fn

Use to select the type of direct key.

Data range	Factory set value
1: Type 1 2: Type 2	1



Content of Type 1 or 2

Direct key type	Direct key1	Direct key2	Direct key3
Type 1	A/M transfer key	MONI key	AREA key
Type 2	A/M transfer key	R/L transfer key	R/S transfer key

A/M: Auto/Manual

R/L: Remote/Local

R/S: RUN/STOP

Related parameters

Engineering mode:

- Direct key 1 (P. 7-67)
- Direct key 2 (P. 7-67)
- Direct key 3 (P. 7-68)

Function block 21 (F21.)

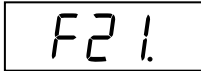

This is the first parameter symbol of Function block 21 (F21.).

F21.

Input type

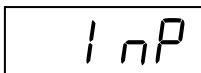

Data range: 0 to 26 (refer to the following table)



A measured input is a universal input but requires hardware selection (of a Voltage (low) or (high) input group). The input select switch enables hardware selection. (Refer to next page.)

Data range	Hardware	Factory set value
0: TC input K 1: TC input J 2: TC input R 3: TC input S 4: TC input B 5: TC input E 6: TC input N 7: TC input T 8: TC input W5Re/W26Re 9: TC input PLII 10: TC input U 11: TC input L 12: RTD input Pt100 13: RTD input JPt100 14: Current input 0 to 20 mA DC 15: Current input 4 to 20 mA DC 19: Voltage (low) input 0 to 1 V DC 20: Voltage (low) input 0 to 100 mV DC 21: Voltage (low) input 0 to 10 mV DC 25: Voltage (low) input ± 100 mV DC 26: Voltage (low) input ± 10 mV DC	Voltage (low) input group	If no input range code is specified: 0 If the input type is specified by the model and suffix code when ordering, that input type becomes the factory set value.
16: Voltage (high) input 0 to 10 V DC 17: Voltage (high) input 0 to 5 V DC 18: Voltage (high) input 1 to 5 V DC 24: Voltage (high) input ± 1 V DC	Voltage (high) input group	



Do not set to any number (including 22 and 23) which is not described in the input range table above. This may cause malfunctioning.

Continued on the next page.

Continued from the previous page.



As the Decimal point position, Input scale high and Input scale low are initialized if the input type is changed, it is necessary to conduct the re-setting.

A value of “3 % of input span” is automatically set at the Start determination point.

For the parameters which will be initialized if the input type is changed, refer to **7.5.2 Precaution against parameter change (P. 7-55)**.

Related parameters

Engineering mode:

- Display unit (P. 7-71)
- Decimal point position (P. 7-71)
- Input scale high, Input scale low (P. 7-72)

■ Hardware selection

The Voltage (low) or (high) input group is selected by the input select switch (for Measured input) at the side of the instrument. Turn the Measured input switch by a small screwdriver.

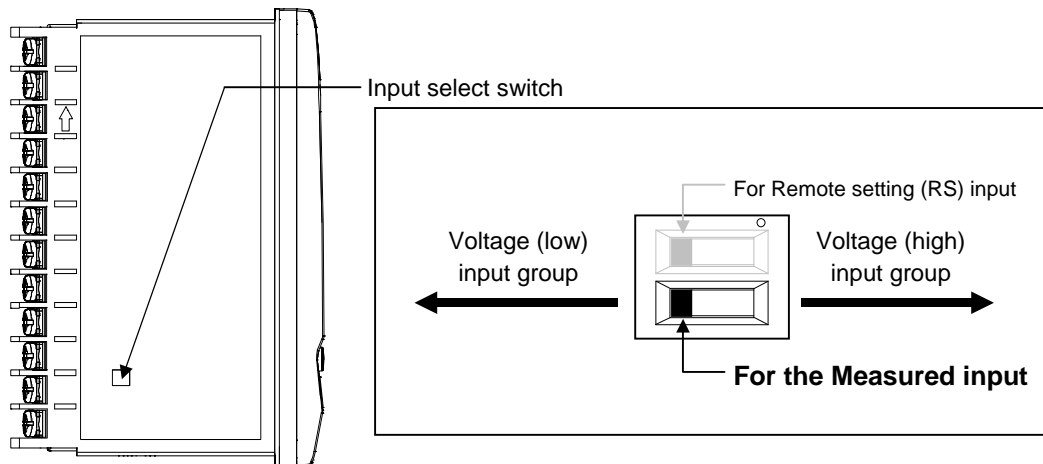

F21.

Display unit

Unit

Use to select the temperature unit for Thermocouple (TC) and RTD inputs.

Data range	Factory set value
0: °C 1: °F	If no input range code is specified: 0 If the Display unit type is specified by the model and suffix code when ordering, that Display unit becomes the factory set value.



The invalidity in case of the Voltage/Current inputs.

F21.

Decimal point position

PGDP

Use to select the Decimal point position of the input range.

Data range	Factory set value
0: No decimal place 1: One decimal place 2: Two decimal places 3: Three decimal places 4: Four decimal places TC input: K, J, E: Only 0 or 1 can be set. T, U, L: Only 1 can be set. Other than the above: Only 0 can be set. RTD input: From 0 to 2 can be set. Voltage (V)/Current (I) inputs: From 0 to 4 can be set.	If no input range code is specified: 0 If the Decimal point position is specified by the model and suffix code when ordering, that Decimal point position becomes the factory set value.

Related parameters

Engineering mode:

- Input type (P. 7-69)
- Input scale high, Input scale low (P. 7-72)

F21.

Input scale high**Input scale low**

PC5H

PC5L

Use to set the high limit and low limit of the input scale range.

Data range	Factory set value
Input scale high TC/RTD inputs: Input scale low to Maximum value of the selected input range Varies with the setting of the Decimal point position (P. 7-71).	Maximum value of the selected input range
Voltage (V)/Current (I) inputs: -19999 to +19999 Varies with the setting of the Decimal point position (P. 7-71).	100.0
Input scale low TC/RTD inputs: Minimum value of the selected input range to Input scale high Varies with the setting of the Decimal point position (P. 7-71).	Minimum value of the selected input range
Voltage (V)/Current (I) inputs: -19999 to +19999 Varies with the setting of the Decimal point position (P. 7-71).	0.0



When a Voltage (V)/Current (I) input type is selected, the input scale high limit can be set lower than the input scale low limit.
(Input scale high limit < Input scale low limit)

Related parameters

Engineering mode:

- Input type (P. 7-69)
- Decimal point position (P. 7-71)

■ Description of function

The input range can be changed for temperature input (TC/RTD).

For Voltage (V)/Current (I) input, display scaling can be made in the range of -19999 to +19999.

Example (temperature input): When the range of -200.0 to +800.0 °C for Thermocouple Type K is changed to 0.0 to 400.0 °C

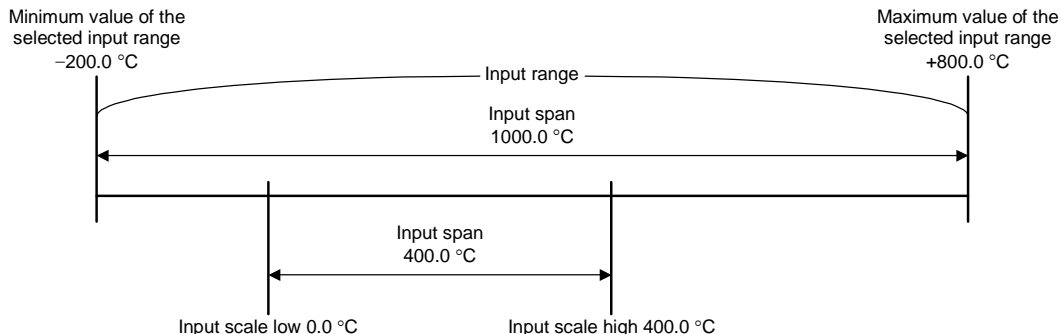

When the scale for temperature input is changed, it is recommended to be changed within the input range. If any value exceeding the input range is set, input resolution may vary.



If the Input scale high or low limit is changed, a value of “3 % of input span” is automatically set at the Start determination point.

Example [Voltage (V)/Current (I) inputs]:

When the input scale is changed to "0.0 to 50.0" from "0.0 to 100.0" at a voltage input of 1 to 5 V DC

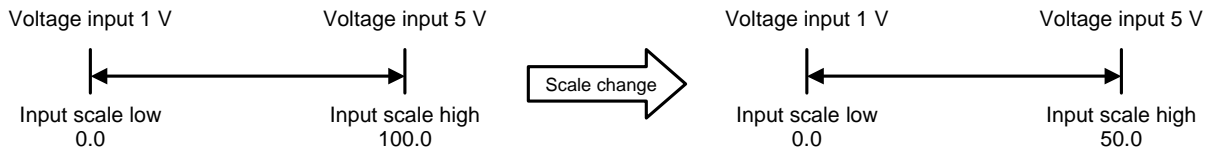

Table 1: Input range table

Input type		Data range		Hardware
TC input	K	-200.0 to +400.0 °C	-328.0 to +400.0 °F	Voltage (low) input group
		-200.0 to +800.0 °C	-250.0 to +800.0 °F	
		-200 to +1372 °C	-328 to +2502 °F	
	J	0.0 to 400.0 °C	-200.0 to +700.0 °F	
		-200.0 to +400.0 °C	-328.0 to +1200 °F	
		-200.0 to +800.0 °C	-328 to +2192 °F	
	T	-200.0 to +400.0 °C	-328.0 to +752.0 °F	
	S	-50 to +1768 °C	-58 to +3214 °F	
	R	-50 to +1768 °C	-58 to +3214 °F	
	E	-200.0 to +700.0 °C	-328.0 to +1292.0 °F	
		-200 to +1000 °C	-328 to +1832 °F	
	B	0 to 1800 °C	0 to 3272 °F	
	N	0 to 1300 °C	0 to 2372 °F	
	PLII	0 to 1390 °C	0 to 2534 °F	
W5Re/W26Re	0 to 2300 °C	0 to 4200 °F		
U	0.0 to 600.0 °C	32.0 to 1112.0 °F		
L	0.0 to 900.0 °C	32.0 to 1652.0 °F		
RTD input	Pt100	-100.00 to +100.00 °C	-199.99 to +199.99 °F	
		-200.0 to +850.0 °C	-328.0 to +1562.0 °F	
	JPt100	-100.00 to +100.00 °C	-199.99 to +199.99 °F	
		-200.0 to +640.0 °C	-328.0 to +1184.0 °F	
Current input	0 to 20 mA DC	Programmable range -19999 to +19999 (The decimal point position of the input range is selectable.)		Voltage (high) input group
	4 to 20 mA DC			
Voltage (low) input	0 to 1 V DC			
	0 to 100 mV DC			
	0 to 10 mV DC			
	±100 mV DC			
	±10 mV DC			
Voltage (high) input	0 to 10 V DC			
	0 to 5 V DC			
	1 to 5 V DC			
	±1 V DC			

F21.

Input error determination point (high)

Input error determination point (low)

P_{oH}

P_{oL}

If the Measured value (PV) is above the Input error determination point (high) or below the Input error determination point (low), Action (high) at input error or Action (low) at input error will be taken.

Data range	Factory set value
Input error determination point (high) Input scale low – (5 % of input span) to Input scale high + (5 % of input span) Varies with the setting of the Decimal point position (P. 7-71).	TC/RTD inputs: Input scale high + (5 % of input span) Voltage (V)/Current (I) inputs: 105.0
Input error determination point (low) Input scale low – (5 % of input span) to Input scale high + (5 % of input span) Varies with the setting of the Decimal point position (P. 7-71).	TC/RTD inputs: Input scale low – (5 % of input span) Voltage (V)/Current (I) inputs: –5.0

Related parameters

Engineering mode:

- Decimal point position (P. 7-71)
- Action (high) at input error, Action (low) at input error (P. 7-135)
- Manipulated output value at input error (P. 7-136)

■ **Example: When the input scale range is –200 to +1372 °C**

Input span: 1572
 5 % of input span: 79 (78.6 was rounded off)
 Setting range: –279 to +1451 °C

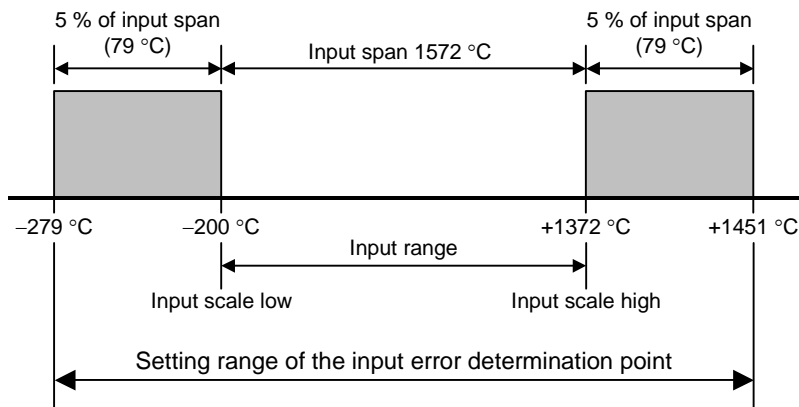

F21.

Burnout direction

605

Use to select Burnout direction in input break. When input break is detected by the controller, the measured value go either Upscale or Downscale according to the Burnout direction setting.

Data range	Factory set value
0: Upscale 1: Downscale	0



The Burnout direction setting are effective only for Thermocouple input and Voltage (low) input.



For the following types of input, the action when an input break occurs is fixed, regardless of the Burnout direction setting.

RTD input: Upscale

Voltage (high) input: Downscale (display of about 0 V)

Current input: Downscale (display of about 0 mA)

F21.

Square root extraction

59r

Use to select Use/Unuse of the Square root extraction for the measured value.

Data range	Factory set value
0: Unused 1: Used	0

Related parameter

Setup setting mode:

- PV low input cut-off (P. 7-41)

■ Description of function

The controller can receive the input signal directly from a differential pressure type flow transmitter by using Square root extraction function without using a square root extractor.

F21.

Power supply frequencyPF_r9

Use to select the Power supply frequency of the controller suited to the application. If the display on the screen flickers, set the value to the same value as the power frequency used.

Data range	Factory set value
0: 50 Hz 1: 60 Hz	0



No power frequency can be changed while if can be normally measured with the Current transformer (CT) input and/or Power feed forward (PFF) input provided.

F21.

Sampling cycle

SNP

This is a sampling time when measured input is captured.

Data range	Factory set value
0: 50 ms 1: 100 ms 2: 250 ms	1

Function block 22 (F22.)

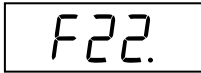

This is the first parameter symbol of Function block 22 (F22.).

F22.

Remote setting input type

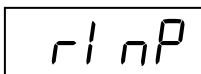

Data range: 14 to 21 (refer to the following table)



Remote setting (RS) input requires hardware selection (of a Voltage (low) or (high) input group). The input select switch enables hardware selection.

Data range	Hardware	Factory set value
14: Current input 0 to 20 mA DC 15: Current input 4 to 20 mA DC	Voltage (low) input group	If no Remote setting input type is specified: 15 If the Remote setting input type is specified by model and suffix code when ordering, that Remote setting input type becomes the factory set value.
16: Voltage input 0 to 10 V DC 17: Voltage input 0 to 5 V DC 18: Voltage input 1 to 5 V DC	Voltage (high) input group	
19: Voltage input 0 to 1 V DC 20: Voltage input 0 to 100 mV DC 21: Voltage input 0 to 10 mV DC	Voltage (low) input group	

■ Hardware selection

The Voltage (low) or (high) input group is selected by the input select switch (for Remote setting (RS) input) at the side of the instrument. Turn the Remote setting (RS) input switch by a small screwdriver.

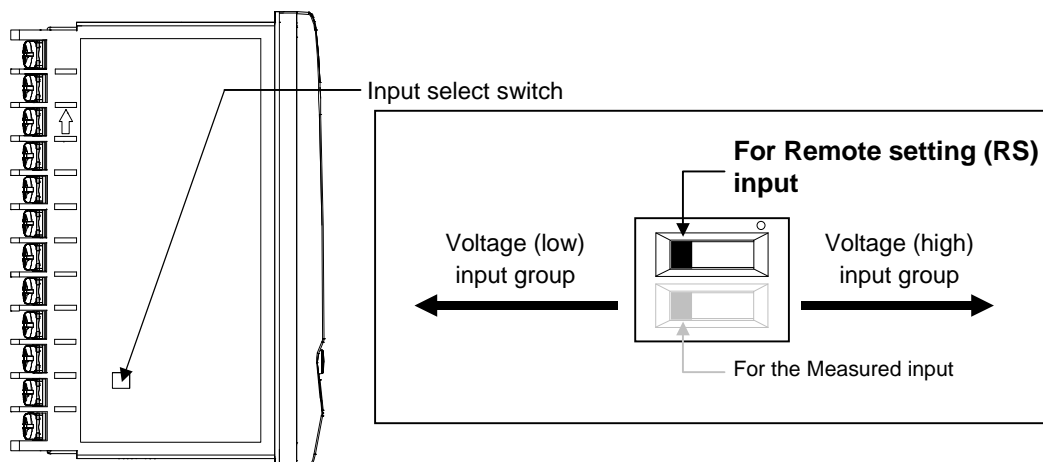

Function block 23 (F23.)

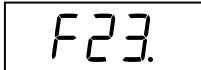

This is the first parameter symbol of Function block 23 (F23.).

F23.

Digital input (DI) assignment

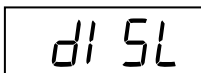

Use to assign the function (Memory area, Operation mode) for the Digital inputs (DI1 to DI7).

Data range	Factory set value
1 to 8 (For details, refer to the following table.)	1

Table 1 Digital input (DI) assignment

Set value	DI1	DI2	DI3	DI4	DI5	DI6	DI7
	Terminal No.30-31	Terminal No.30-32	Terminal No.30-33	Terminal No.30-34	Terminal No.13-14	Terminal No.13-15	Terminal No.13-16
1	Memory area number transfer (1 to 8)			Memory area set *	Unused	Unused	Unused
2	Memory area number transfer (1 to 8)			Memory area set *	RUN/STOP transfer	Remote/Local transfer	Auto/Manual transfer
3	Memory area number transfer (1 to 8)			Memory area set *	RUN/STOP transfer	Remote/Local transfer	Interlock release
4	Memory area number transfer (1 to 8)			Memory area set *	RUN/STOP transfer	Auto/Manual transfer	Interlock release
5	Memory area number transfer (1 to 8)			Memory area set *	Remote/Local transfer	Auto/Manual transfer	Interlock release
6	Memory area number transfer (1 to 8)			Memory area set *	RUN/STOP transfer	Unused	Interlock release
7	Memory area number transfer (1 to 8)			Memory area set *	Remote/Local transfer	Unused	Interlock release
8	Memory area number transfer (1 to 8)			Memory area set *	Auto/Manual transfer	Unused	Interlock release

* Only when ZK-1165 specification was specified, memory area transfer is possible without area set input.
For memory area transfer by ZK-1165 specification, refer to **ZK-1165 Specification (IMR01W08-E□)**.

 For Digital input (DI) transfer, refer to following page.

- Memory area number transfer: Refer to **6.9 Control Area Transfer (P. 6-32)**.
- RUN/STOP transfer: Refer to **6.4 RUN/STOP Transfer (P. 6-11)**.
- Remote/Local transfer: Refer to **6.8 Remote/Local Transfer (P. 6-28)**.
- Auto/Manual transfer: Refer to **6.7 Auto/Manual Transfer (P. 6-23)**.
- Interlock release: Refer to **6.10 Interlock Release (P. 6-36)**.

Function block 30 (F30.)

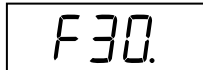

This is the first parameter symbol of Function block 30 (F30.).

F30.

Output assignment

Digital
output
OPTION



This is used to assign the Output function (Control output, Event output, etc.) for the Output (OUT1 and OUT2) and the Digital output (DO1 to DO4).

Data range	Factory set value
1 to 7 (For details, refer to table 1.)	2 If an Output assignment is specified when the order is placed, the factory set value will be the specified value.

Related parameters





Engineering mode:

- Energized/De-energized (P. 7-80)
- Alarm (ALM) lamp lighting condition 1 (P. 7-81)
- Alarm (ALM) lamp lighting condition 2 (P. 7-81)
- Event 1 type (P. 7-85)
- Event 2 type (P. 7-95)
- CT1 assignment (P. 7-117)
- CT2 assignment (P. 7-121)
- Event 3 type (P. 7-102)
- Event 4 type (P. 7-109)

Table 1: Output assignment

Set value	OUT1	OUT2	DO1	DO2	DO3	DO4
1	MV1	MV2	EV1	EV2	EV3	EV4
2	MV1	MV2	EV1	EV2	EV3	HBA1, HBA2
3	MV1	MV2	EV1	EV2	HBA1, HBA2	FAIL
4	MV1	MV2	EV1	HBA1, HBA2	EV3	EV4
5	MV1	HBA1, HBA2	EV1	EV2	EV3	EV4
6	MV1	HBA1, HBA2	EV1	EV2	EV3	FAIL
7	MV1	FAIL	EV1	EV2	EV3	EV4

MV1: Manipulated output (control output) [heat-side] EV1: Event 1 EV3: Event 3 HBA1: Heater break alarm 1 FAIL: FAIL output
 MV2: Manipulated output (control output) [cool-side] EV2: Event 2 EV4: Event 4 HBA2: Heater break alarm 2

-  “Energized” or “De-energized” of DO1 to DO4 can be changed in Engineering mode.
-  Only “De-energized” is available for the FAIL output. No “Energized” is available.
-  An output logic becomes *OR* output when two or more Output functions are assigned to one output.
-  To use for Heat/Cool PID control or Position proportioning PID control, select a set value from 1 to 4.
-  Outputs and Event functions not specified in the model code is not valid if specified.

F30.

Timer 1 Timer 3
Timer 2 Timer 4

0111

0112

0113

0114

The customization tool is required for using the Timer 1 to 4 function. As this function cannot be used at present, do not change it.

Data range	Factory set value
0.0 to 600.0 seconds	0.0

F30.

Energized/De-energized

Digital output
OPTION

E4C

Use to select the Energized or De-energized for the Digital output 1 to 4 (DO1 to DO4). However, the FAIL alarm is fixed to De-energized. (When at FAIL alarm occurrence: Contact opened)

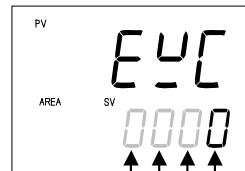

Factory set value: 0000 (energized)

- DO1: 0: Energized 1: De-energized
- DO2: 0: Energized 1: De-energized
- DO3: 0: Energized 1: De-energized
- DO4: 0: Energized 1: De-energized

Related parameters

Engineering mode:

- Output assignment (P. 7-79)
- Event 1 type (P. 7-85)
- Event 2 type (P. 7-95)
- Event 3 type (P. 7-102)
- Event 4 type (P. 7-109)

■ Description of function

Energized: Relay contact is closed under the event or alarm status.

De-energized: Relay contact opens under the event or alarm status.

Diagram for explaining operation (At power-ON)

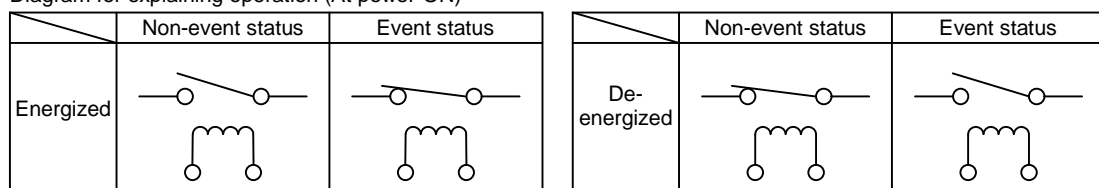

F30.

Alarm (ALM) lamp lighting condition 1**Alarm (ALM) lamp lighting condition 2**

ALC1

Use to set an alarm (ALM) lamp lighting conditions to Event 1 to Event 4, HBA1 and HBA2.

ALC2

The alarm lamp is lit through the *OR* operation of Event 1 to Event 4, HBA1 and HBA2 each of which is set to “1: ALM lamp is lit.”

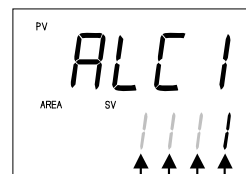

Factory set value: 1111 (ALM lamp is lit)

Event 1 (EV1):	0: ALM lamp is not lit	1: ALM lamp is lit
Event 2 (EV2):	0: ALM lamp is not lit	1: ALM lamp is lit
Event 3 (EV3):	0: ALM lamp is not lit	1: ALM lamp is lit
Event 4 (EV4):	0: ALM lamp is not lit	1: ALM lamp is lit

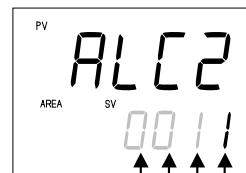

Factory set value: 0011 (ALM lamp is lit)

Heater break alarm 1 (HBA1):	0: ALM lamp is not lit	1: ALM lamp is lit
Heater break alarm 2 (HBA2):	0: ALM lamp is not lit	1: ALM lamp is lit
“0” fixed (No setting)		
“0” fixed (No setting)		

Related parameters**Engineering mode:**

- Output assignment (P. 7-79)
- Event 1 type (P. 7-85)
- Event 2 type (P. 7-95)
- Event 3 type (P. 7-102)
- Event 4 type (P. 7-109)
- CT1 assignment (P. 7-117)
- CT2 assignment (P. 7-121)

F30.**Output status at STOP mode**

It is selected whether or not Event output, Heater break alarm output or Transmission output is continued or turned off when the controller is set to STOP (control stop).

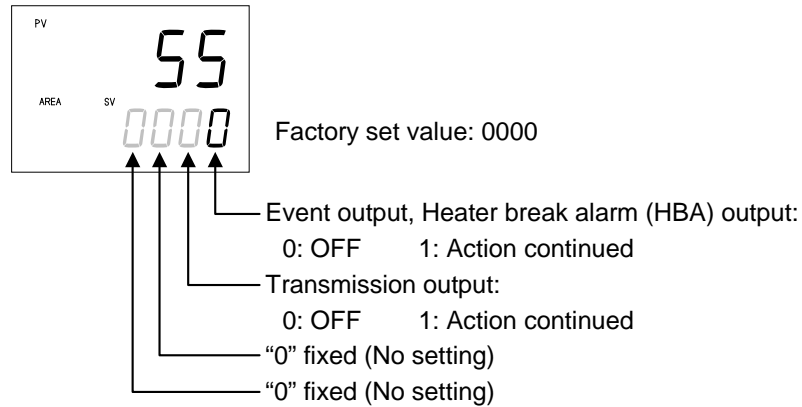
**Related parameters****Engineering mode:**

- Output assignment (P. 7-79)
- Transmission output type (P. 7-83)
- Event 1 type (P. 7-85)
- Event 2 type (P. 7-95)
- Event 3 type (P. 7-102)
- Event 4 type (P. 7-109)
- CT1 assignment (P. 7-117)
- CT2 assignment (P. 7-121)

Function block 33 (F33.)

F33.

This is the first parameter symbol of Function block 33 (F33.).

F33.

Transmission output type

AO
OPTION

AO

Use to select the transmission output type.

Data range	Factory set value
0: None	1
1: Measured value (PV)	
2: Set value (SV) monitor	
3: Deviation value	
4: Manipulated output value (MV1) [heat-side] *	
5: Manipulated output value (MV2) [cool-side]	
6: Set value (SV)	
7: Remote setting (RS) input value	

* For Position proportioning PID control: Feedback resistance input value

Related parameters

Engineering mode:

- Output status at STOP mode (P. 7-82)
- Transmission output scale high (P. 7-84)
- Transmission output scale low (P. 7-84)

■ Description of function

The Transmission output (analog output) is the function of outputting the state of Measured value (PV), Set value (SV), Deviation value, Manipulated output value or Remote setting (RS) input value as a Voltage or Current signal. It is possible to record the state of Measured value (PV) or Set value (SV) when connected to a recorder.

Output types of transmission output:

Voltage output	0 to 1 V DC, 0 to 5 V DC, 0 to 10 V DC, 1 to 5 V DC
Current output	0 to 20 mA DC, 4 to 20 mA DC

F33.

Transmission output scale high
Transmission output scale low



AHS

ALS

Use to set a scale high limit value or low limit value of the Transmission output.

Data range	Factory set value
When the transmission type is the Measured value (PV), Set value (SV) monitor, Set value (SV) or Remote setting (RS) input value: Input scale low to Input scale high Varies with the setting of the Decimal point position (P. 7-71).	Transmission output scale high: Input scale high Transmission output scale low: Input scale low
When the transmission type is the deviation value: -Input span to +Input span	
When the transmission type is the Manipulated output value (MV1) or Manipulated output value (MV2): -5.0 to +105.0 %	

The Decimal point position is the same as Decimal point position (PGdP) of the input.

Related parameters

Engineering mode:

- Decimal point position (P. 7-71)
- Output status at STOP mode (P. 7-82)
- Transmission output type (P. 7-83)

■ Description of function

This is the function of scaling the output range for the content of transmission selected by the Transmission output type (Ao).

Example: If scaling is made under the following conditions

- Output signal type: Current output 4 to 20 mA DC
- Transmission output type (Ao): Measured value (PV)
- Transmission output scale high (AHS): +1372 °C
- Transmission output scale low (ALS): -200 °C

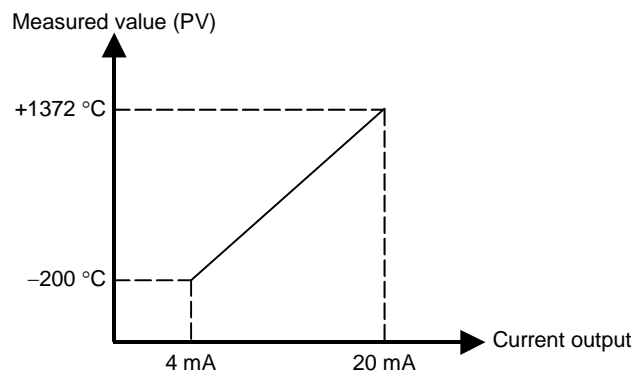

Function block 41 (F41.)

F41.

This is the first parameter symbol of Function block 41 (F41.).

F41.

Event 1 type

E51

Use to select a action type of the Event 1.

Data range	Factory set value	
0: None	0	
Deviation action: 1: Deviation high ¹ 2: Deviation low ¹ 3: Deviation high/low ¹ 4: Band ¹	If the event type is specified by the model and suffix code when ordering, that event type becomes the factory set value.	
Input value action: 5: Process high ¹ 6: Process low ¹		
Set value action: 7: Set value (SV) high 8: Set value (SV) low		
Manipulated output value action: 10: Manipulated output value (MV1) high [heat-side] ^{1,2} 11: Manipulated output value (MV1) low [heat-side] ^{1,2} 12: Manipulated output value (MV2) high [cool-side] ¹ 13: Manipulated output value (MV2) low [cool-side] ¹		
9: Unused		
Do not set to "9: Unused" for Event 1.		

¹ Event hold action is available.

² The Manipulated output value (MV) corresponds to the Feedback resistance (FBR) input value when Feedback resistance (FBR) input is used.

Related parameters

Parameter setting mode:

- Event 1 set value (P. 7-21)

Continued on the next page.

Continued from the previous page.

Engineering mode:

- Output assignment (P. 7-79)
- Energized/De-energized (P. 7-80)
- Alarm (ALM) lamp lighting condition 1 (P. 7-81)
- Output status at STOP mode (P. 7-82)
- Event 1 hold action (P. 7-87)
- Event 1 interlock (P. 7-89)
- Event 1 differential gap (P. 7-90)
- Event 1 delay timer (P. 7-91)
- Force ON of Event 1 action (P. 7-93)

■ Description of function

Diagrams of the event action type are shown in the following.

ON: Event action turned on

OFF: Event action turned off

(▲ : Set value (SV) Δ : Event set value ☆ : Event differential gap)

Deviation action:

If the Deviation (PV – SV) reaches the Event set value, Event ON occurs.

1: Deviation high (using SV monitor value)

(Event set value is greater than 0.)

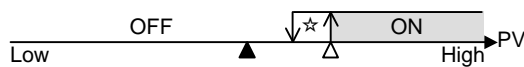

(Event set value is less than 0.)



2: Deviation low (using SV monitor value)

(Event set value is greater than 0.)



(Event set value is less than 0.)

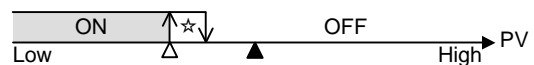

3: Deviation high/low (using SV monitor value)

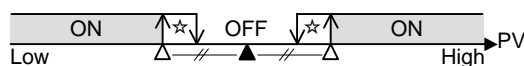

4: Band (using SV monitor value)



Input value action:

When the Measured value (PV) reaches the Event set value, Event ON occurs.

5: Process high

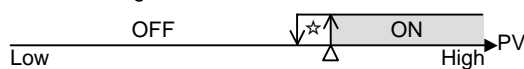

6: Process low

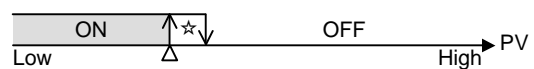

Set value action:

When the Set value (SV) reaches the Event set value, Event ON occurs.

7: SV high:

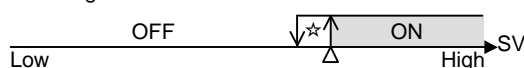

8: SV low:

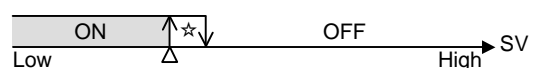

Manipulated output value action:

When the Manipulated output value (MV) reaches the Event set value, Event ON occurs.

10: MV high [heat-side]

12: MV high [cool-side]

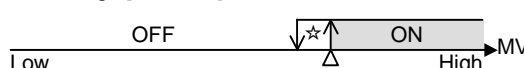

11: MV low [heat-side]

13: MV low [cool-side]

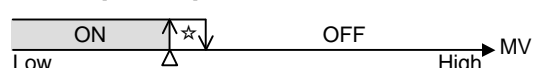

F41.

Event 1 hold action**EHo 1**

Use to set an Event hold action for the Event 1.

Data range	Factory set value
0: OFF 1: Hold action ON (Only Hold action) <ul style="list-style-type: none"> • Validate the Hold action when the power is turned on. • Validate the Hold action when transferred from STOP (control STOP) to RUN (control RUN). 2: Re-hold action ON (Hold and Re-hold actions) <ul style="list-style-type: none"> • Validate the Hold action when the power is turned on. • Validate the Hold action when transferred from STOP (control STOP) to RUN (control RUN). • Validate the Re-hold action when the Set value (SV) is changed. However, if the rate of setting change limiter is set to any function other than "OFF (Unused)" or in the Remote mode, the Re-hold action becomes invalid.	0 If the event type is specified by the model and suffix code when ordering, the factory set value of Event 1 hold action differs depending on that event type.



When high alarm with Hold/Re-hold action is used for Event function, alarm does not turn on while Hold action is in operation. Use in combination with a high alarm without Hold action in order to prevent overheating which may occur by failure of control devices, such as welding of relays.

Related parameters

Parameter setting mode:

- Event 1 set value (P. 7-21)

Engineering mode:

- Energized/De-energized (P. 7-80)
- Alarm (ALM) lamp lighting condition 1 (P. 7-81)
- Output status at STOP mode (P. 7-82)
- Event 1 type (P. 7-85)
- Event 1 interlock (P. 7-89)
- Event 1 differential gap (P. 7-90)
- Event 1 delay timer (P. 7-91)
- Force ON of Event 1 action (P. 7-93)

■ Description of function**(1) Hold action**

When Hold action is ON, the event action is suppressed at start-up or STOP to RUN until the Measured value has entered the non-event range.

Continued on the next page.

Continued from the previous page.

[With hold action]

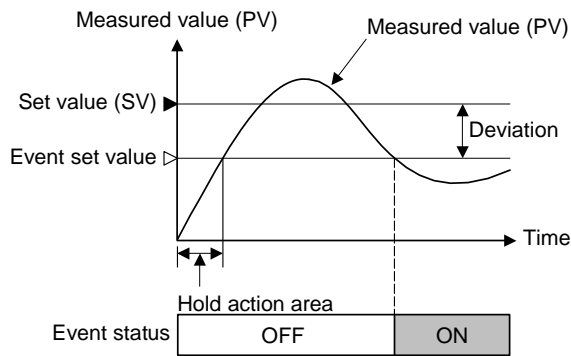

[Without hold action]

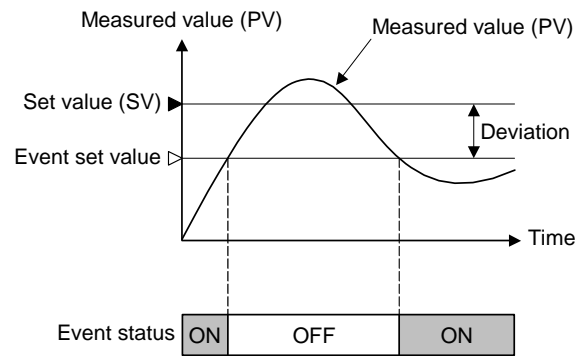

(2) Re-hold action

When Re-hold action is ON, the event action is also suppressed at the control set value change until the Measured value has entered the non-event range.

Action condition	1: Hold action ON (Only Hold action)	2: Re-hold action ON (Hold and Re-hold actions)
When the power is turned on	Hold action	Hold action
When transferred from STOP (control STOP) to RUN (control RUN)	Hold action	Hold action
When the Set value (SV) is changed	Without Hold and Re-hold actions	Re-hold action



The Re-hold action is invalid for any of the following. However, the Hold action is valid.

- When Setting change rate limiter other than “OFF (Unused)” are set
- When Remote/Local transfer is the remote mode

[Example] When Event 1 type is the deviation low:

When Re-hold action is OFF and event output type is deviation, the event output is produced due to the Set value change. The Re-hold action suppresses the alarm output until the Measured value has entered the non-event range again.

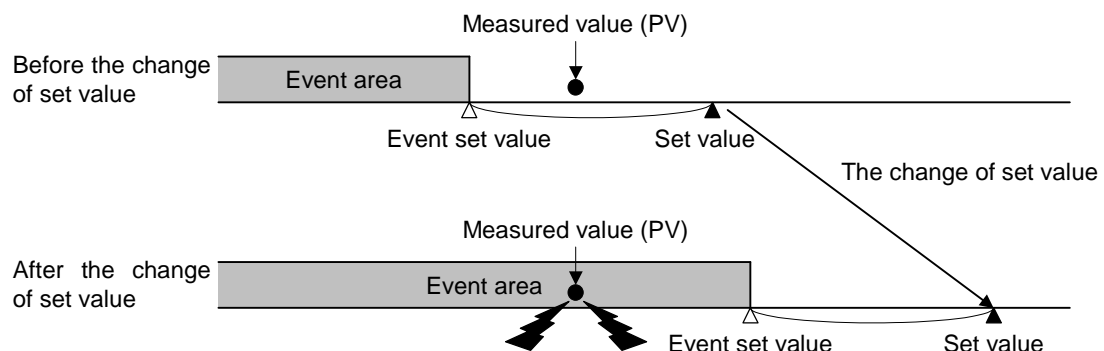

F41.

Event 1 interlock

E1L1

Use to select the Interlock function for the Event 1.

Data range	Factory set value
0: Unused	0
1: Used	

Related parameters

Parameter setting mode:

- Event 1 set value (P. 7-21)

Engineering mode:

- Energized/De-energized (P. 7-80)
- Alarm (ALM) lamp lighting condition 1 (P. 7-81)
- Output status at STOP mode (P. 7-82)
- Event 1 type (P. 7-85)
- Event 1 hold action (P. 7-87)
- Event 1 differential gap (P. 7-90)
- Event 1 delay timer (P. 7-91)
- Force ON of Event 1 action (P. 7-93)

■ Description of function

The Event interlock function is used to hold the event state even if the Measured value (PV) is out of the event area after its entry into the area once.

[Example] When the Event interlock function is used for deviation high

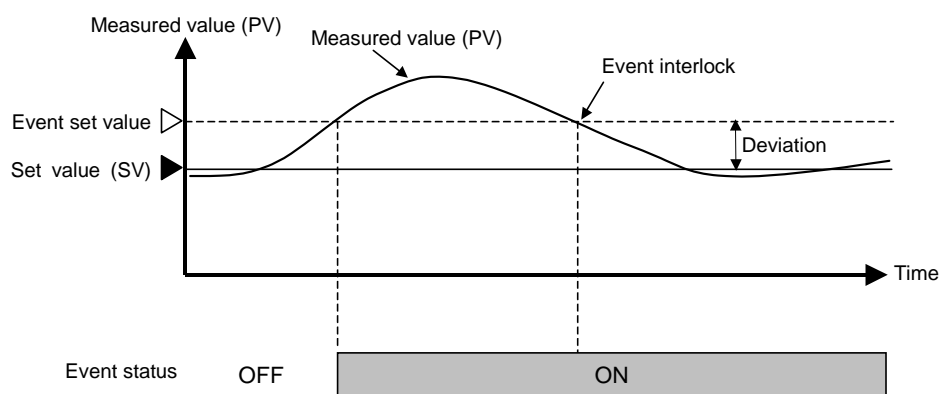

[Without Event hold action]

F41.

Event 1 differential gapDigital
output
OPTION

EH1

Use to set a Differential gap of the Event 1.

Data range	Factory set value
When Event 1 type is deviation, input value or set value actions: 0 to Input span Varies with the setting of the Decimal point position (P. 7-71).	2
When Event 1 type is Manipulated output value action: 0.0 to 110.0 %	If the event type is specified by the model and suffix code when ordering, the factory set value of Event 1 differential gap differs depending on that event type.

Related parameters

Parameter setting mode:

- Event 1 set value (P. 7-21)

Engineering mode:

- Decimal point position (P. 7-71)
- Energized/De-energized (P. 7-80)
- Alarm (ALM) lamp lighting condition 1 (P. 7-81)
- Output status at STOP mode (P. 7-82)
- Event 1 type (P. 7-85)
- Event 1 hold action (P. 7-87)
- Event 1 interlock (P. 7-89)
- Event 1 delay timer (P. 7-91)
- Force ON of Event 1 action (P. 7-93)

■ Description of function

It prevents chattering of event output due to the measured value fluctuation around the Event set value.

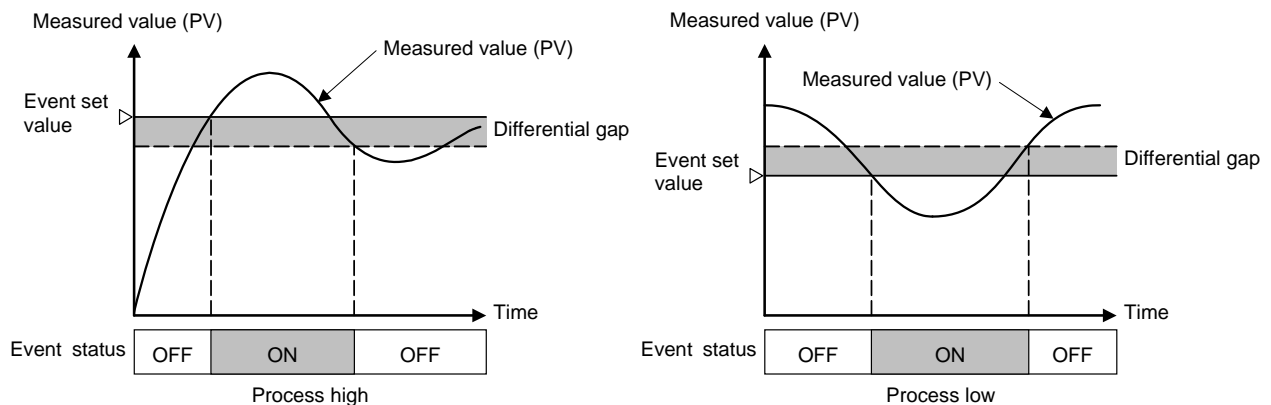

F41.

Event 1 delay timer

 Digital
output
OPTION

Event 1 delay timer is to set an output delay time for event outputs.

Data range	Factory set value
0.0 to 600.0 seconds	0.0

Related parameters

Parameter setting mode:

- Event 1 set value (P. 7-21)

Engineering mode:

- Energized/De-energized (P. 7-80)
- Alarm (ALM) lamp lighting condition 1 (P. 7-81)
- Output status at STOP mode (P. 7-82)
- Event 1 type (P. 7-85)
- Event 1 hold action (P. 7-87)
- Event 1 interlock (P. 7-89)
- Event 1 differential gap (P. 7-90)
- Force ON of Event 1 action (P. 7-93)

■ Description of function

When an event condition becomes ON status, the output is suppressed until the Delay timer set time elapses. After the time is up, if the event output is still ON status, the output will be produced.

Example: When the setting of Event 1 delay timer is 50.0 seconds

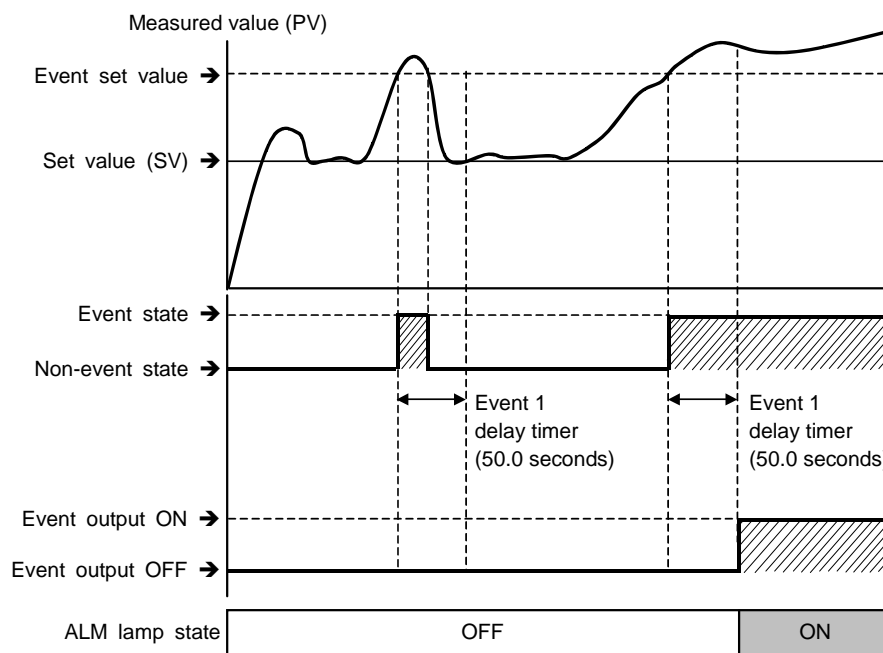

Continued on the next page.

Continued from the previous page.



The Event delay timer is also activated for the following cases.

- When set to the event state simultaneously with power turned on.
- When set to the event state simultaneously with control changed to RUN (control start) from STOP (control stop).



In the event wait state, no event output is turned on even after the Event delay timer preset time has elapsed.



The Event delay timer is reset for the following cases.

- When power failure occurs while the Event delay timer is being activated.
- When control is changed to STOP (control stop) from RUN (control start) while the Event delay timer is being activated.

F41.

Force ON of Event 1 action

EEo1

Select the operation state that is output (force ON) as the event action.

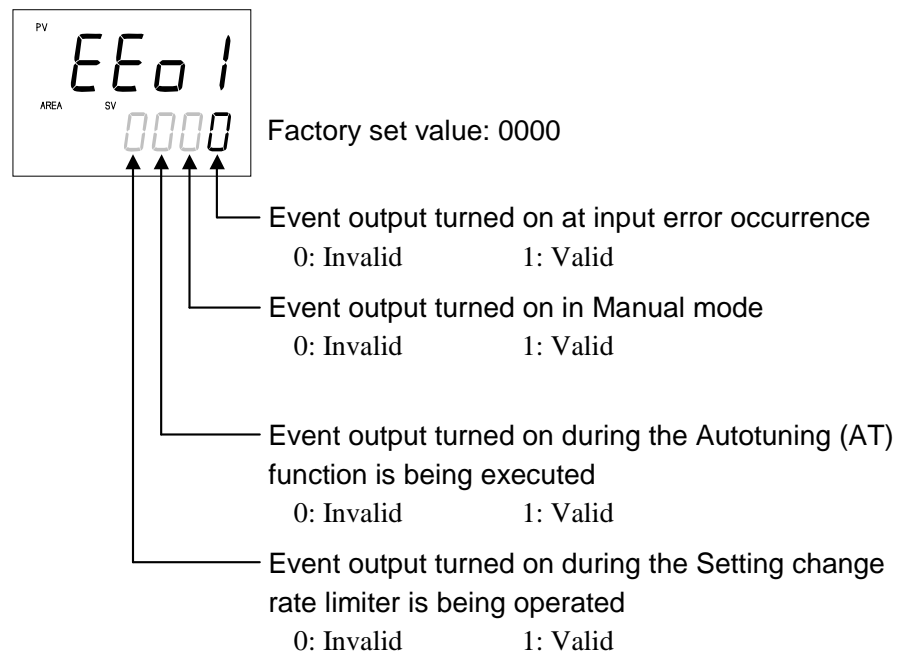
**Related parameters**

Engineering mode:

- Input error determination point (high),
Input error determination point (low) (P. 7-74)

Continued on the next page.

Continued from the previous page.

■ **Description of function**

Event action at input error:

Example: Input range: 0 to 400 °C
 Input error determination point (high): 300 °C
 Input error determination point (low): 50 °C

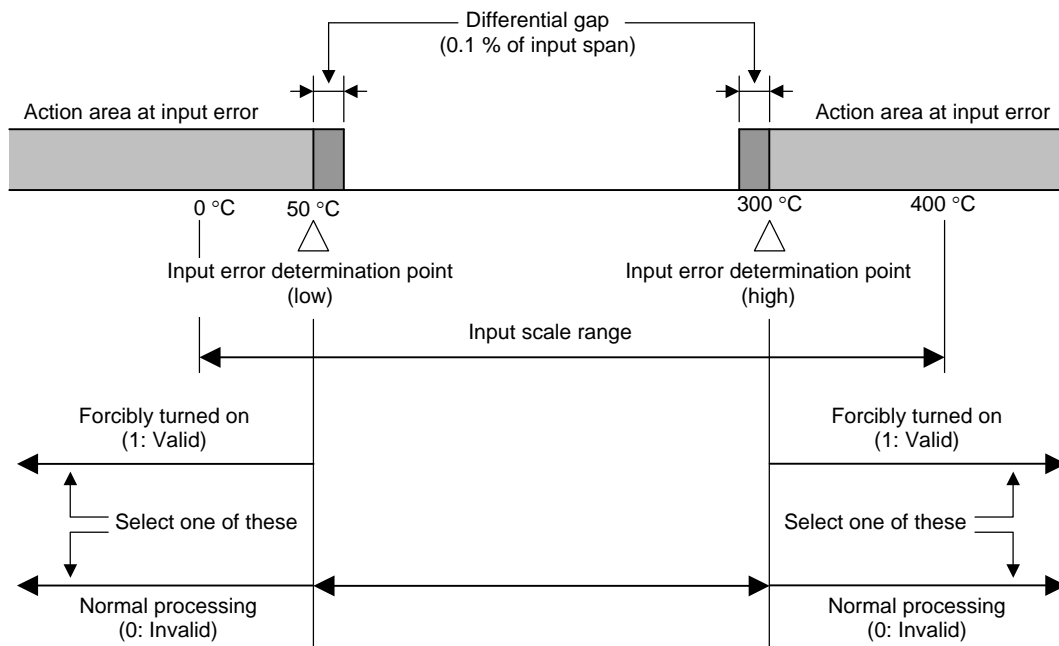

“0: Invalid”: The event output is produced depending on the selected event action status.
 “1: Valid”: The event output is forcibly turned on regardless of the event action status.

Function block 42 (F42.)

F42.

This is the first parameter symbol of Function block 42 (F42.).

F42.

Event 2 type

E52

Use to select a action type of the Event 2.

Data range	Factory set value	
0: None	0	
Deviation action: 1: Deviation high ¹ 2: Deviation low ¹ 3: Deviation high/low ¹ 4: Band ¹	If the event type is specified by the model and suffix code when ordering, that event type becomes the factory set value.	
Input value action: 5: Process high ¹ 6: Process low ¹		
Set value action: 7: Set value (SV) high 8: Set value (SV) low		
Manipulated output value action: 10: Manipulated output value (MV1) high [heat-side] ^{1,2} 11: Manipulated output value (MV1) low [heat-side] ^{1,2} 12: Manipulated output value (MV2) high [cool-side] ¹ 13: Manipulated output value (MV2) low [cool-side] ¹		
9: Unused		
Do not set to "9: Unused" for Event 2.		

¹ Event hold action is available.

² The Manipulated output value (MV) corresponds to the Feedback resistance (FBR) input value when Feedback resistance (FBR) input is used.

Related parameters

Parameter setting mode:

- Event 2 set value (P. 7-21)

Continued on the next page.

Continued from the previous page.

Engineering mode

- Output assignment (P. 7-79)
- Energized/De-energized (P. 7-80)
- Alarm (ALM) lamp lighting condition 1 (P. 7-81)
- Output status at STOP mode (P. 7-82)
- Event 2 hold action (P. 7-97)
- Event 2 interlock (P. 7-98)
- Event 2 differential gap (P. 7-99)
- Event 2 delay timer (P. 7-100)
- Force ON of Event 2 action (P. 7-101)

■ **Description of function**

For function description, refer to **Event 1 type (P. 7-85)**.

F42.

Event 2 hold action

EHo2

Use to set an Event hold action for the Event 2.

Data range	Factory set value
0: OFF 1: Hold action ON (Only Hold action) <ul style="list-style-type: none"> • Validate the Hold action when the power is turned on. • Validate the Hold action when transferred from STOP (control STOP) to RUN (control RUN). 2: Re-hold action ON (Hold and Re-hold actions) <ul style="list-style-type: none"> • Validate the Hold action when the power is turned on. • Validate the Hold action when transferred from STOP (control STOP) to RUN (control RUN). • Validate the Re-hold action when the Set value (SV) is changed. However, if the rate of setting change limiter is set to any function other than “OFF (Unused)” or in the Remote mode, the Re-hold action becomes invalid.	0 If the event type is specified by the model and suffix code when ordering, the factory set value of Event 2 hold action differs depending on that event type.



When high alarm with Hold/Re-hold action is used for Event function, alarm does not turn on while Hold action is in operation. Use in combination with a high alarm without Hold action in order to prevent overheating which may occur by failure of control devices, such as welding of relays.

Related parameters

Parameter setting mode:

- Event 2 set value (P. 7-21)

Engineering mode

- Energized/De-energized (P. 7-80)
- Alarm (ALM) lamp lighting condition 1 (P. 7-81)
- Output status at STOP mode (P. 7-82)
- Event 2 type (P. 7-95)
- Event 2 interlock (P. 7-98)
- Event 2 differential gap (P. 7-99)
- Event 2 delay timer (P. 7-100)
- Force ON of Event 2 action (P. 7-101)

■ Description of function

For function description, refer to **Event 1 hold action (P. 7-87)**.

F42.

Event 2 interlock

Use to select the Interlock function for the Event 2.

Data range	Factory set value
0: Unused 1: Used	0

Related parameters

Parameter setting mode:

- Event 2 set value (P. 7-21)

Engineering mode

- Energized/De-energized (P. 7-80)
- Alarm (ALM) lamp lighting condition 1 (P. 7-81)
- Output status at STOP mode (P. 7-82)
- Event 2 type (P. 7-95)
- Event 2 hold action (P. 7-97)
- Event 2 differential gap (P. 7-99)
- Event 2 delay timer (P. 7-100)
- Force ON of Event 2 action (P. 7-101)

■ Description of function

For function description, refer to **Event 1 interlock (P. 7-89)**.

F42.

Event 2 differential gap

EH2

Use to set a Differential gap of the Event 2.

Data range	Factory set value
When Event 2 type is deviation, input value or set value actions: 0 to Input span Varies with the setting of the Decimal point position (P. 7-71).	2
When Event 2 type is Manipulated output value action: 0.0 to 110.0 %	If the event type is specified by the model and suffix code when ordering, the factory set value of Event 2 differential gap differs depending on that event type.

Related parameters

Parameter setting mode:

- Event 2 set value (P. 7-21)

Engineering mode:

- Decimal point position (P. 7-71)
- Energized/De-energized (P. 7-80)
- Alarm (ALM) lamp lighting condition 1 (P. 7-81)
- Output status at STOP mode (P. 7-82)
- Event 2 type (P. 7-95)
- Event 2 hold action (P. 7-97)
- Event 2 interlock (P. 7-98)
- Event 2 delay timer (P. 7-100)
- Force ON of Event 2 action (P. 7-101)

■ Description of functionFor function description, refer to **Event 1 differential gap (P. 7-90)**.

F42.

Event 2 delay timerDigital
output
OPTION

E472

Event 2 delay timer is to set an output delay time for event outputs.

Data range	Factory set value
0.0 to 600.0 seconds	0.0

Related parameters

Parameter setting mode:

- Event 2 set value (P. 7-21)

Engineering mode

- Energized/De-energized (P. 7-80)
- Alarm (ALM) lamp lighting condition 1 (P. 7-81)
- Output status at STOP mode (P. 7-82)
- Event 2 type (P. 7-95)
- Event 2 hold action (P. 7-97)
- Event 2 interlock (P. 7-98)
- Event 2 differential gap (P. 7-99)
- Force ON of Event 2 action (P. 7-101)

■ Description of functionFor function description, refer to **Event 1 delay timer (P. 7-91)**.

F42.

Force ON of Event 2 actionDigital
output
OPTION

EE02

Select the operation state that is output (force ON) as the event action.

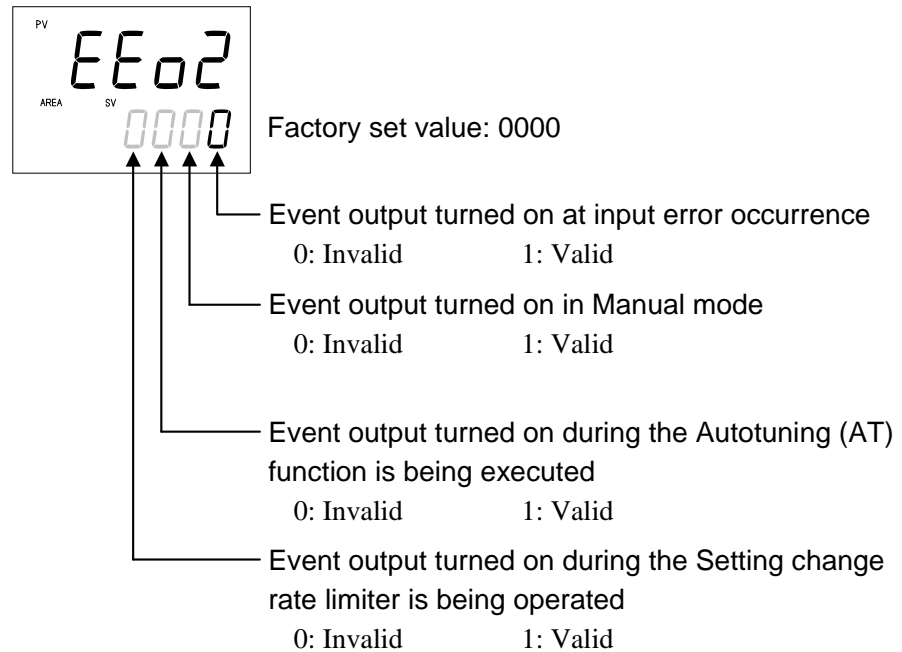
**Related parameters****Engineering mode:**

- Input error determination point (high),
Input error determination point (low) (P. 7-74)

■ Description of functionFor function description, refer to **Force ON of Event 1 action (P. 7-93)**.

Function block 43 (F43.)

F43.

This is the first parameter symbol of Function block 43 (F43.).

F43.

Event 3 type

E53

Use to select a action type of the Event 3.

Data range	Factory set value
0: None	0
Deviation action: 1: Deviation high ¹ 2: Deviation low ¹ 3: Deviation high/low ¹ 4: Band ¹	If the event type is specified by the model and suffix code when ordering, that event type becomes the factory set value.
Input value action: 5: Process high ¹ 6: Process low ¹	
Set value action: 7: Set value (SV) high 8: Set value (SV) low	
Manipulated output value action: 10: Manipulated output value (MV1) high [heat-side] ^{1,2} 11: Manipulated output value (MV1) low [heat-side] ^{1,2} 12: Manipulated output value (MV2) high [cool-side] ¹ 13: Manipulated output value (MV2) low [cool-side] ¹	
9: Unused Do not set to "9: Unused" for Event 3.	

¹ Event hold action is available.

² The Manipulated output value (MV) corresponds to the Feedback resistance (FBR) input value when Feedback resistance (FBR) input is used.

Related parameters

Parameter setting mode:

- Event 3 set value (P. 7-21)

Continued on the next page.

Continued from the previous page.

Engineering mode:

- Output assignment (P. 7-79)
- Energized/De-energized (P. 7-80)
- Alarm (ALM) lamp lighting condition 1 (P. 7-81)
- Output status at STOP mode (P. 7-82)
- Event 3 hold action (P. 7-104)
- Event 3 interlock (P. 7-105)
- Event 3 differential gap (P. 7-106)
- Event 3 delay timer (P. 7-107)
- Force ON of Event 3 action (P. 7-108)

■ Description of function

For function description, refer to **Event 1 type (P. 7-85)**.

F43.

Event 3 hold action

EH03

Use to set an Event hold action for the Event 3.

Data range	Factory set value
0: OFF 1: Hold action ON (Only Hold action) <ul style="list-style-type: none"> • Validate the Hold action when the power is turned on. • Validate the Hold action when transferred from STOP (control STOP) to RUN (control RUN). 2: Re-hold action ON (Hold and Re-hold actions) <ul style="list-style-type: none"> • Validate the Hold action when the power is turned on. • Validate the Hold action when transferred from STOP (control STOP) to RUN (control RUN). • Validate the Re-hold action when the Set value (SV) is changed. However, if the rate of setting change limiter is set to any function other than “OFF (Unused)” or in the Remote mode, the Re-hold action becomes invalid.	0 If the event type is specified by the model and suffix code when ordering, the factory set value of Event 3 hold action differs depending on that event type.



When high alarm with Hold/Re-hold action is used for Event function, alarm does not turn on while Hold action is in operation. Use in combination with a high alarm without Hold action in order to prevent overheating which may occur by failure of control devices, such as welding of relays.

Related parameters

Parameter setting mode:

- Event 3 set value (P. 7-21)

Engineering mode:

- Energized/De-energized (P. 7-80)
- Alarm (ALM) lamp lighting condition 1 (P. 7-81)
- Output status at STOP mode (P. 7-82)
- Event 3 type (P. 7-102)
- Event 3 interlock (P. 7-105)
- Event 3 differential gap (P. 7-106)
- Event 3 delay timer (P. 7-107)
- Force ON of Event 3 action (P. 7-108)

■ Description of function

For function description, refer to **Event 1 hold action (P. 7-87)**.

F43.

Event 3 interlock

Use to select the Interlock function for the Event 3.

Data range	Factory set value
0: Unused 1: Used	0

Related parameters

Parameter setting mode:

- Event 3 set value (P. 7-21)

Engineering mode:

- Energized/De-energized (P. 7-80)
- Alarm (ALM) lamp lighting condition 1 (P. 7-81)
- Output status at STOP mode (P. 7-82)
- Event 3 type (P. 7-102)
- Event 3 hold action (P. 7-104)
- Event 3 differential gap (P. 7-106)
- Event 3 delay timer (P. 7-107)
- Force ON of Event 3 action (P. 7-108)

■ Description of function

For function description, refer to **Event 1 interlock (P. 7-89)**.

F43.

Event 3 differential gapDigital
output
OPTION

EH3

Use to set a Differential gap of the Event 3.

Data range	Factory set value
When Event 3 type is deviation, input value or set value actions: 0 to Input span Varies with the setting of the Decimal point position (P. 7-71).	2
When Event 3 type is Manipulated output value action: 0.0 to 110.0 %	If the event type is specified by the model and suffix code when ordering, the factory set value of Event 3 differential gap differs depending on that event type.

Related parameters

Parameter setting mode:

- Event 3 set value (P. 7-21)

Engineering mode:

- Decimal point position (P. 7-71)
- Energized/De-energized (P. 7-80)
- Alarm (ALM) lamp lighting condition 1 (P. 7-81)
- Output status at STOP mode (P. 7-82)
- Event 3 type (P. 7-102)
- Event 3 hold action (P. 7-104)
- Event 3 interlock (P. 7-105)
- Event 3 delay timer (P. 7-107)
- Force ON of Event 3 action (P. 7-108)

■ Description of functionFor function description, refer to **Event 1 differential gap (P. 7-90)**.

F43.

Event 3 delay timerDigital
output
OPTION

E473

Event 3 delay timer is to set an output delay time for event outputs.

Data range	Factory set value
0.0 to 600.0 seconds	0.0

Related parameters

Parameter setting mode:

- Event 3 set value (P. 7-21)

Engineering mode:

- Energized/De-energized (P. 7-80)
- Alarm (ALM) lamp lighting condition 1 (P. 7-81)
- Output status at STOP mode (P. 7-82)
- Event 3 type (P. 7-102)
- Event 3 hold action (P. 7-104)
- Event 3 interlock (P. 7-105)
- Event 3 differential gap (P. 7-106)
- Force ON of Event 3 action (P. 7-108)

■ Description of functionFor function description, refer to **Event 1 delay timer (P. 7-91)**.

F43.

Force ON of Event 3 action

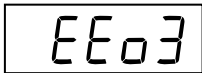

Select the operation state that is output (force ON) as the event action.

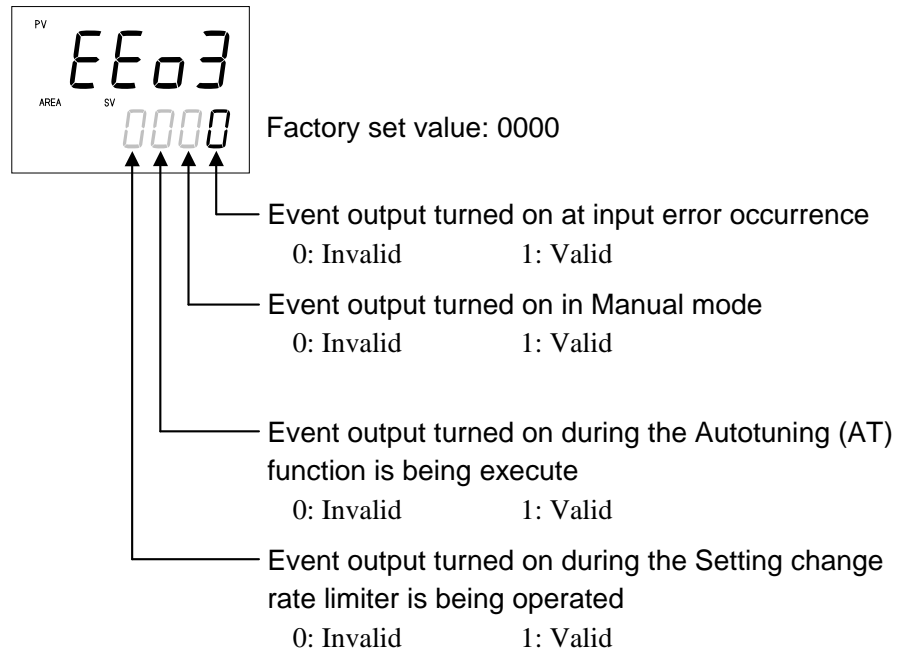

Related parameters

Engineering mode

- Input error determination point (high),
Input error determination point (low) (P. 7-74)

■ **Description of function**

For function description, refer to **Force ON of Event 1 action (P. 7-93)**.

Function block 44 (F44.)

F44.

This is the first parameter symbol of Function block 44 (F44.).

F44.

Event 4 type

E54

Use to select a action type of the Event 4.

Data range	Factory set value
0: None	0
Deviation action: 1: Deviation high ¹ 2: Deviation low ¹ 3: Deviation high/low ¹ 4: Band ¹	If the event type is specified by the model and suffix code when ordering, that event type becomes the factory set value.
Input value action: 5: Process high ¹ 6: Process low ¹	
Set value action: 7: Set value (SV) high 8: Set value (SV) low	
Alarm action: 9: Control loop break alarm (LBA)	
Manipulated output value action: 10: Manipulated output value (MV1) high [heat-side] ^{1,2} 11: Manipulated output value (MV1) low [heat-side] ^{1,2} 12: Manipulated output value (MV2) high [cool-side] ¹ 13: Manipulated output value (MV2) low [cool-side] ¹	

¹ Event hold action is available.

² The Manipulated output value (MV) corresponds to the Feedback resistance (FBR) input value when Feedback resistance (FBR) input is used.

Related parameters

Parameter setting mode:

- Event 4 set value (P. 7-21)
- Control loop break alarm (LBA) time (P. 7-22)
- LBA deadband (P. 7-23)

Continued on the next page.

Continued from the previous page.

Engineering mode:

- Output assignment (P. 7-79)
- Energized/De-energized (P. 7-80)
- Alarm (ALM) lamp lighting condition 1 (P. 7-81)
- Output status at STOP mode (P. 7-82)
- Event 4 hold action (P. 7-111)
- Event 4 interlock (P. 7-112)
- Event 4 differential gap (P. 7-113)
- Event 4 delay timer (P. 7-114)
- Force ON of Event 4 action (P. 7-115)

■ Description of function

For a description of functions other than the Control loop break alarm (LBA) function, to Event 1 type (P. 7-85).

Control loop break alarm (LBA)

The Control loop break alarm (LBA) function is used to detect a load (heater) break or a failure in the external actuator (magnet relay, etc.), or a failure in the control loop caused by an input (sensor) break.

The LBA function is activated when control output reaches 0 % (low limit with output limit function) or 100 % (high limit with output limit function). LBA monitors variation of the Measured value (PV) for the length of LBA time. When the LBA time has elapsed and the PV is still within the alarm determination range, the LBA will be ON.

The LBA function produces the alarm when any of the following conditions occurs.

LBA determination range: TC/RTD inputs: 2 °C [°F] (fixed)
Voltage/Current inputs: 0.2 % of input span (fixed)

• When the control output reaches 0 % (low limit with output limit function)

For direct action: When the LBA time has passed and the PV has not risen beyond the alarm determination range, the alarm will be turned on.

For reverse action: When the LBA time has passed and the PV has not fallen below the alarm determination range, the alarm will be turned on.

• When the output exceeds 100 % (low limit with output high function)

For direct action: When the LBA time has passed and the PV has not fallen below the alarm determination range, the alarm will be turned on.

For reverse action: When the LBA time has passed and the PV has not risen beyond the alarm determination range, the alarm will be turned on.



If the Autotuning function is used, the LBA time is automatically set twice as large as the Integral time. The LBA setting time will not be changed even if the Integral time is changed.



LBA function is not operative when:

- AT function is activated
- The controller is in STOP mode
- The control type is Heat/Cool PID control
- LBA function is set to "0."
- LBA function is not assigned to Event 4 (ES4).



The LBA function does not detect a location which causes alarm status. If LBA alarm is ON, check each device or wiring of the control loop.



While the LBA is ON (under alarm status), the following conditions cancel the alarm status and LBA will be OFF:

- The Measured value (PV) rises beyond (or falls below) the LBA determination range within the LBA setting time.
- The Measured value (PV) enters within the LBA deadband.

F44.

Event 4 hold action

EH04

Use to set an Event hold action for the Event 4.

Data range	Factory set value
0: OFF 1: Hold action ON (Only Hold action) <ul style="list-style-type: none"> • Validate the Hold action when the power is turned on. • Validate the Hold action when transferred from STOP (control STOP) to RUN (control RUN). 2: Re-hold action ON (Hold and Re-hold actions) <ul style="list-style-type: none"> • Validate the Hold action when the power is turned on. • Validate the Hold action when transferred from STOP (control STOP) to RUN (control RUN). • Validate the Re-hold action when the Set value (SV) is changed. However, if the rate of setting change limiter is set to any function other than “OFF (Unused)” or in the Remote mode, the Re-hold action becomes invalid.	0 If the event type is specified by the model and suffix code when ordering, the factory set value of Event 4 hold action differs depending on that event type.



When high alarm with Hold/Re-hold action is used for Event function, alarm does not turn on while Hold action is in operation. Use in combination with a high alarm without Hold action in order to prevent overheating which may occur by failure of control devices, such as welding of relays.

Related parameters

Parameter setting mode:

- Event 4 set value (P. 7-21)

Engineering mode:

- Energized/De-energized (P. 7-80)
- Alarm (ALM) lamp lighting condition 1 (P. 7-81)
- Output status at STOP mode (P. 7-82)
- Event 4 type (P. 7-109)
- Event 4 interlock (P. 7-112)
- Event 4 differential gap (P. 7-113)
- Event 4 delay timer (P. 7-114)
- Force ON of Event 4 action (P. 7-115)

■ Description of function

For function description, refer to **Event 1 hold action (P. 7-87)**.

F44.

Event 4 interlock

E1L4

Use to select the Interlock function for the Event 4.

Data range	Factory set value
0: Unused 1: Used	0

Related parameters

Parameter setting mode:

- Event 4 set value (P. 7-21)
- Control loop break alarm (LBA) time (P. 7-22)
- LBA deadband (P. 7-23)

Engineering mode:

- Energized/De-energized (P. 7-80)
- Alarm (ALM) lamp lighting condition 1 (P. 7-81)
- Output status at STOP mode (P. 7-82)
- Event 4 type (P. 7-109)
- Event 4 hold action (P. 7-111)
- Event 4 differential gap (P. 7-113)
- Event 4 delay timer (P. 7-114)
- Force ON of Event 4 action (P. 7-115)

■ Description of functionFor function description, refer to **Event 1 interlock (P. 7-89)**.

F44.

Event 4 differential gapDigital
output
OPTION

EH4

Use to set a Differential gap of the Event 4.

Data range	Factory set value
When Event 4 type is deviation, input value or set value actions: 0 to Input span Varies with the setting of the Decimal point position (P. 7-71).	2
When Event 4 type is Manipulated output value action: 0.0 to 110.0 %	If the event type is specified by the model and suffix code when ordering, the factory set value of Event 4 differential gap differs depending on that event type.



For the Control loop break alarm (LBA), invalidated even if a differential gap is set.

Related parameters

Parameter setting mode

- Event 4 set value (P. 7-21)

Engineering mode:

- Decimal point position (P. 7-71)
- Energized/De-energized (P. 7-80)
- Alarm (ALM) lamp lighting condition 1 (P. 7-81)
- Output status at STOP mode (P. 7-82)
- Event 4 type (P. 7-109)
- Event 4 hold action (P. 7-111)
- Event 4 interlock (P. 7-112)
- Event 4 delay timer (P. 7-114)
- Force ON of Event 4 action (P. 7-115)

■ Description of function

For function description, refer to **Event 1 differential gap (P. 7-90)**.

F44.

Event 4 delay timerDigital
output
OPTION

E4T4

Event 4 delay timer is to set an output delay time for event outputs.

Data range	Factory set value
0.0 to 600.0 seconds	0.0

Related parameters

Parameter setting mode:

- Event 4 set value (P. 7-21)
- Control loop break alarm (LBA) time (P. 7-22)
- LBA deadband (P. 7-23)

Engineering mode:

- Energized/De-energized (P. 7-80)
- Alarm (ALM) lamp lighting condition 1 (P. 7-81)
- Output status at STOP mode (P. 7-82)
- Event 4 type (P. 7-109)
- Event 4 hold action (P. 7-111)
- Event 4 interlock (P. 7-112)
- Event 4 differential gap (P. 7-113)
- Force ON of Event 4 action (P. 7-115)

■ Description of functionFor function description, refer to **Event 1 delay timer (P. 7-91)**.

F44.

Force ON of Event 4 action

EE04

Select the operation state that is output (force ON) as the event action.

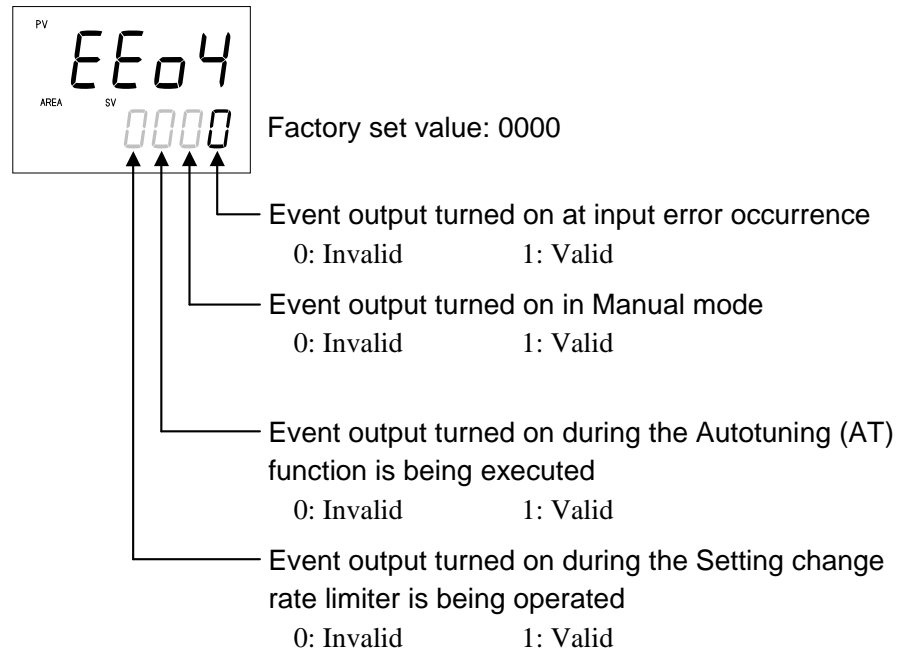

For the Control loop break alarm (LBA), invalidated even if the Force ON of Event 4 action is set.

Related parameters

Engineering mode:

- Input error determination point (high),
Input error determination point (low) (P. 7-74)

■ Description of function

For function description, refer to **Force ON of Event 1 action (P. 7-93)**.

Function block 45 (F45.)

F45.

This is the first parameter symbol of Function block 45 (F45.).

The settings of parameters in this group become valid on the controller with the CT input (optional) function.

In addition, in order to output the Heater break alarm it is necessary to specify Output 2 (OUT2) or Digital output (optional).

F45.

CT1 ratio

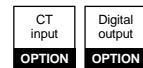

[Cr1]

Use to set the number of turns in the Current transformer which is used to monitor the current flowing through the load. There are two types of dedicated Current transformers.

The set value differs depending on the Current transformer (CT) type.

Data range	Factory set value
0 to 9999 Set the appropriate values below for each Current transformer type. CTL-6-P-N: 800 CTL-12-S56-10L-N: 1000	If the Current transformer (CT) type is not specified when the order is placed: 800 If CTL-6-P-N is specified for the Current transformer (CT) type: 800 If CTL-12-S56-10L-N is specified for the Current transformer (CT) type: 1000

Related parameters

Setup setting mode:

- Heater break alarm 1 (HBA1) set value (P. 7-35)
- Heater break determination point 1 (P. 7-38)
- Heater melting determination point 1 (P. 7-39)

Engineering mode:

- CT1 assignment (P. 7-117)
- Heater break alarm 1 (HBA1) type (P. 7-118)

F45.

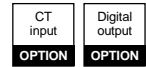
CT1 assignment

CTA1

Use to assign the Current transformer (CT) input to an output from OUT1 or OUT2.

The CT input 1 is tied to HBA1, and the CT input 2 tied to HBA2, so when CT1 is assigned to OUT1, HBA1 is also automatically assigned to OUT1.

Data range	Factory set value
0: None (Heater break alarm function OFF)	1
1: OUT1	
2: OUT2	
3 to 6: Do not set this one	



To use HBA for a three-phase load, both CT inputs can be assigned to the same output.

Related parameters**Setup setting mode:**

- Heater break alarm 1 (HBA1) set value (P. 7-35)
- Heater break determination point 1 (P. 7-38)
- Heater melting determination point 1 (P. 7-39)

Engineering mode:

- Output assignment (P. 7-79)
- CT1 ratio (P. 7-116)
- Heater break alarm 1 (HBA1) type (P. 7-117)

F45.

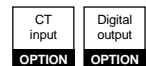
Heater break alarm 1 (HBA1) type

Hb51

Use to select the Heater break alarm 1 (HBA1) type.

Data range	Factory set value
0: Heater break alarm 1 (HBA1) type A The type A corresponds to the time-proportional control output.	Varies with the type of control output (OUT1) being specified at ordering. Relay, Voltage pulse, Triac, or Open-collector output: 0
1: Heater break alarm 1 (HBA1) type B The type B corresponds to the continuous control output.	Voltage/Current continuous output: 1

Related parameters**Setup setting mode:**

- Heater break alarm 1 (HBA1) set value (P. 7-35)
- Heater break determination point 1 (P. 7-38)
- Heater melting determination point 1 (P. 7-39)

Engineering mode:

- Output assignment (P. 7-79)
- CT1 ratio (P. 7-116)
- CT1 assignment (P. 7-117)
- Number of heater break alarm 1 (HBA1) delay times (P. 7-119)

■ Description of function

Heater break alarm (HBA) type A:

Heater break alarm (HBA) type A can be used with time-proportional control output (Relay, Voltage pulse, Triac or Open-collector output).

The HBA function monitors the current flowing through the load by a dedicated Current transformer (CT), compares the measured value with the HBA set values, and detects a fault in the heating circuit.

Heater break alarm (HBA) type B:

Heater break alarm (HBA) type B can be used with continuous control output (Voltage/Current continuous output).

The HBA function assumes that the heater current value is proportional* to the control output value of the controller, otherwise viewed as the Manipulated variable (MV), and compare it with the CT input value to detect a fault in the heating or cooling circuit. However, in the case of time-proportional control output, an alarm status is only detected when the output device is melting.

* It is assumed that the current value flowing through the load is at maximum when the control output from the controller is 100 %, and the minimum current value flowing through the load is zero (0) when the control output from the controller is 0 %.



When changing the value of CT assignment, the type of Heater break alarm (HBA) automatically changes.

CT assignment	HBA Type
1: OUT1	Type A (for time-proportional control output) or Type B (for continuous control output)
2: OUT2	
0: None	Type A

Example: OUT1: Relay contact output, OUT2: Voltage/Current continuous output

When changing the value of CT assignment from OUT1 to OUT2, the type of Heater break alarm (HBA) automatically changes from Type A to B.

F45.

Number of heater break alarm 1 (HBA1) delay times

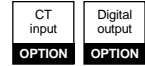

HbC 1

To prevent producing a false alarm, the alarm function waits to produce an alarm status until the measured CT input value is in an alarm range for the preset number of consecutive sampling cycles (Sampling cycle of CT input × 5).

Data range	Factory set value
0 to 255	5

Related parameters

Setup setting mode:

- Heater break alarm 1 (HBA1) set value (P. 7-35)
- Heater break determination point 1 (P. 7-38)
- Heater melting determination point 1 (P. 7-39)

Engineering mode:

- Output assignment (P. 7-79)
- CT1 ratio (P. 7-116)
- CT1 assignment (P. 7-117)
- Heater break alarm 1 (HBA1) type (P. 7-117)

■ Description of function

Heater break alarm (HBA) delay time = Number of delay times × Sampling time *

* Twice of the measured input sampling cycle

Example:

Sampling time: 200 ms (Twice of the measured input sampling cycle [100ms])

Number of delay times: 5 times (factory set value)

$$\text{HBA delay time} = 5 \text{ times} \times 200 \text{ ms} = 1000 \text{ ms} = 1.0 \text{ seconds}$$

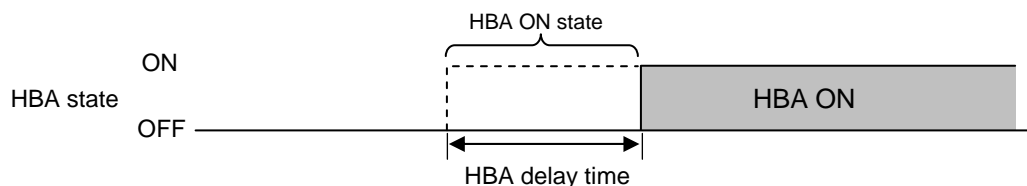

Function block 46 (F46.)

F46.

This is the first parameter symbol of Function block 46 (F46.).

The settings of parameters in this group become valid on the controller with the CT input (optional) function.

In addition, in order to output the Heater break alarm it is necessary to specify Output 2 (OUT2) or Digital output (optional).

F46.

CT2 ratio

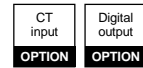

CTr2

Use to set the number of turns in the Current transformer which is used to monitor the current flowing through the load. There are two types of dedicated Current transformers.

Data range	Factory set value
0 to 9999 Set the appropriate values below for each Current transformer type. CTL-6-P-N: 800 CTL-12-S56-10L-N: 1000	If the Current transformer (CT) type is not specified when the order is placed: 800 If CTL-6-P-N is specified for the Current transformer (CT) type: 800 If CTL-12-S56-10L-N is specified for the Current transformer (CT) type: 1000

Related parameters

Setup setting mode:

- Heater break alarm 2 (HBA2) set value (P. 7-35)
- Heater break determination point 2 (P. 7-38)
- Heater melting determination point 2 (P. 7-39)

Engineering mode:

- CT2 assignment (P. 7-121)
- Heater break alarm 2 (HBA2) type (P. 7-122)

F46.

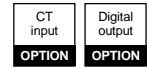
CT2 assignment

Use to assign the Current transformer (CT) input to an output from OUT1 or OUT2.

The CT input 1 is tied to HBA1, and the CT input 2 tied to HBA2, so when CT2 is assigned to OUT2, HBA2 is also automatically assigned to OUT2.

Data range	Factory set value
0: None (Heater break alarm function OFF)	0
1: OUT1	
2: OUT2	
3 to 6: Do not set this one	



To use HBA for a three-phase load, both CT inputs can be assigned to the same output.

Related parameters

Setup setting mode:

- Heater break alarm 2 (HBA2) set value (P. 7-35)
- Heater break determination point 2 (P. 7-38)
- Heater melting determination point 2 (P. 7-39)

Engineering mode:

- Output assignment (P. 7-79)
- CT2 ratio (P. 7-120)
- Heater break alarm 2 (HBA2) type (P. 7-122)

F46.

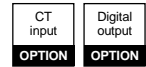
Heater break alarm 2 (HBA2) type

Hb52

Use to select the Heater break alarm 2 (HBA2) type.

Data range	Factory set value
0: Heater break alarm 2 (HBA2) type A The type A corresponds to the time- proportional control output.	0
1: Heater break alarm 2 (HBA2) type B The type B corresponds to the continuous control output.	

Related parameters

Setup setting mode:

- Heater break alarm 2 (HBA2) set value (P. 7-35)
- Heater break determination point 2 (P. 7-38)
- Heater melting determination point 2 (P. 7-39)

Engineering mode:

- Output assignment (P. 7-79)
- CT2 ratio (P. 7-120)
- CT2 assignment (P. 7-121)
- Number of heater break alarm 2 (HBA2) delay times (P. 7-122)

■ Description of functionFor function description, refer to **Heater break alarm 1 (HBA1) type (P. 7-118)**.

F46.

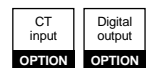
Number of heater break alarm 2 (HBA2) delay times

HbC2

To prevent producing a false alarm, the alarm function waits to produce an alarm status until the measured CT input value is in an alarm range for the preset number of consecutive sampling cycles (Sampling cycle of CT input × 5).

Data range	Factory set value
0 to 255	5

Related parameters

Setup setting mode:

- Heater break alarm 2 (HBA2) set value (P. 7-35)
- Heater break determination point 2 (P. 7-38)
- Heater melting determination point 2 (P. 7-39)

Engineering mode:

- Output assignment (P. 7-79)
- CT2 assignment (P. 7-121)
- CT2 ratio (P. 7-120)
- Heater break alarm 2 (HBA2) type (P. 7-122)

■ Description of functionFor function description, refer to **Number of heater break alarm 1 (HBA1) delay times (P. 7-119)**.

Function block 50 (F50.)

F50.

This is the first parameter symbol of Function block 50 (F50.).

F50. Hot/Cold start

Pd

Use to select the start mode at power recovery.

Data range	Factory set value
0: Hot start 1 2: Cold start 1: Hot start 2 3: STOP start	0

Related parameters

Operation mode:

- Auto/Manual transfer (P. 7-17)

Engineering mode:

- Start determination point (P. 7-124)
- Manipulated output value (MV1) at STOP mode,
Manipulated output value (MV2) at STOP mode (P. 7-136)
- Output limiter low (MV1), Output limiter low (MV2) (P. 7-138)
- Valve action at STOP (P. 7-160)

■ Description of function

The operation of this instrument is not affected by a power failure of 20 ms or less. The control start mode at power recovery after more than 20 ms power failure can be selected as follows.

Action when power failure recovers	Operation mode when power failure recovers	Output value when power failure recovers	
Hot start 1	Same as that before power failure	Near the output value before power failure occurs.	
Hot start 2	Same as that before power failure	Auto mode	Value as a result of control computation ²
		Manual mode	Output limiter low ³
Cold start	Manual	Output limiter low ³	
STOP start	Started in the control stop (STOP) state regardless of the RUN mode before power failure. ¹	Manipulated output value at STOP mode ³	

Factory set value: Hot start 1

¹ If changed to RUN from STOP by RUN/STOP transfer after start, set to the operation mode before power failure occurs.

² The result of control computation varies with the control response parameter.

³ If there is no Feedback resistance (FBR) input in Position proportioning PID control, the following results.

- Hot start 2 (Manual mode): No output (no control motor is driven)
- Cold start: No output (no control motor is driven)
- STOP start: In accordance with the setting of valve action at STOP

Continued on the next page.

Continued from the previous page.



If the Startup tuning (ST) function is executed or an automatic temperature rise is made just when the power is turned on or selection is made from STOP to RUN as one of the startup conditions, control starts at Hot start 2 even if set to Hot start 1 (factory set value).

F50.

Start determination point

PdA

Determination point always set to Hot start 1 when recovered from power failure.

Data range	Factory set value
0 to Input span (The unit is the same as input value.) (0: Operation starts from any start state selected by Hot/Cold start.) Varies with the setting of the Decimal point position (P. 7-71).	3 % of input span

Related parameter

Engineering mode:

- Decimal point position (P. 7-71)
- Hot/Cold start (P. 7-123)

■ Description of function

- The start state is determined according to the Measured value (PV) level [deviation from set value] at power recovery.
- When a Measured value (PV) is between the determination points on the + (plus) and – (minus) sides, always started from Hot start 1 when recovered.
- When a Measured value (PV) is out of the determination points or the Start determination point is set at “0,” operation starts from any start state selected by Hot/Cold start.

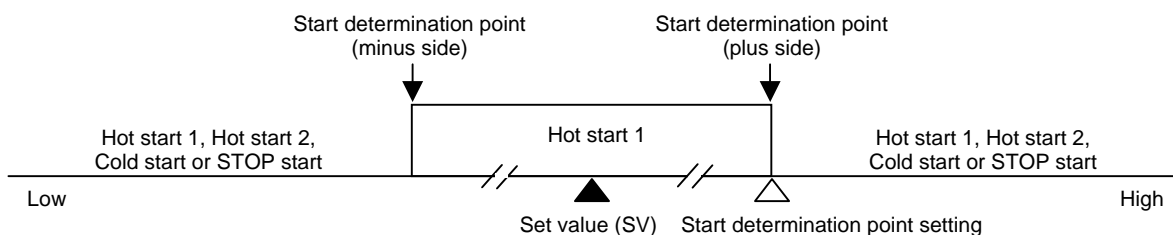





F50.

External input type

CA \bar{n}

Use to select the type of external input.

Data range	Factory set value
0: Remote setting (RS) input 1: Intercontroller communication cascade control 2: Intercontroller communication ratio setting	0

-  Intercontroller communication cascade control or Intercontroller communication ratio setting can be performed when the port of Communication 2 is ready to be used and also the Communication 2 protocol (CMP2) is set to “2: Intercontroller communication.”
-  When cascade control or ratio setting is performed, the master controller is set to “0: Remote setting (RS) input.”
Set each slave controller to “1: Intercontroller communication cascade control” or “2: Intercontroller communication ratio setting.”
-  For the Remote setting (RS) input, refer to **6.8 Remote/Local Transfer (P. 6-28)**.
-  For the cascade control, refer to **6.14.5 Cascade control function (P. 6-82)**.
-  For the ratio setting, refer to **6.14.6 Ratio setting function (P. 6-91)**.

Related parameters

Operation mode:

- Remote/Local transfer (P. 7-18)

Engineering mode:

- Master channel selection (P. 7-126)
- Communication 2 protocol (P. 7-166)

F50.

Master channel selection



Set the master controller address set by Device address2 (Add2) to Master channel selection (MCH) of each slave controller.
 This setting is necessary for the slave controller to identify the master controller when Intercontroller cascade control or Intercontroller ratio setting is performed.

Data range	Factory set value
0 to 31	0

This setting is valid when the Master channel selection is set to “1: Intercontroller communication cascade control” or “2: Intercontroller communication ratio setting.”

Related parameters

Setup setting mode:

- Device address 2 (P. 7-44)

Engineering mode:

- External input type (P. 7-125)

Application: When used in the following condition

- Intercontroller communication: Cascade control or ratio setting
- Address 1: Master controller
- Address 2 and Address 3: Slave controllers

Cascade control or Ratio setting via Intercontroller communication

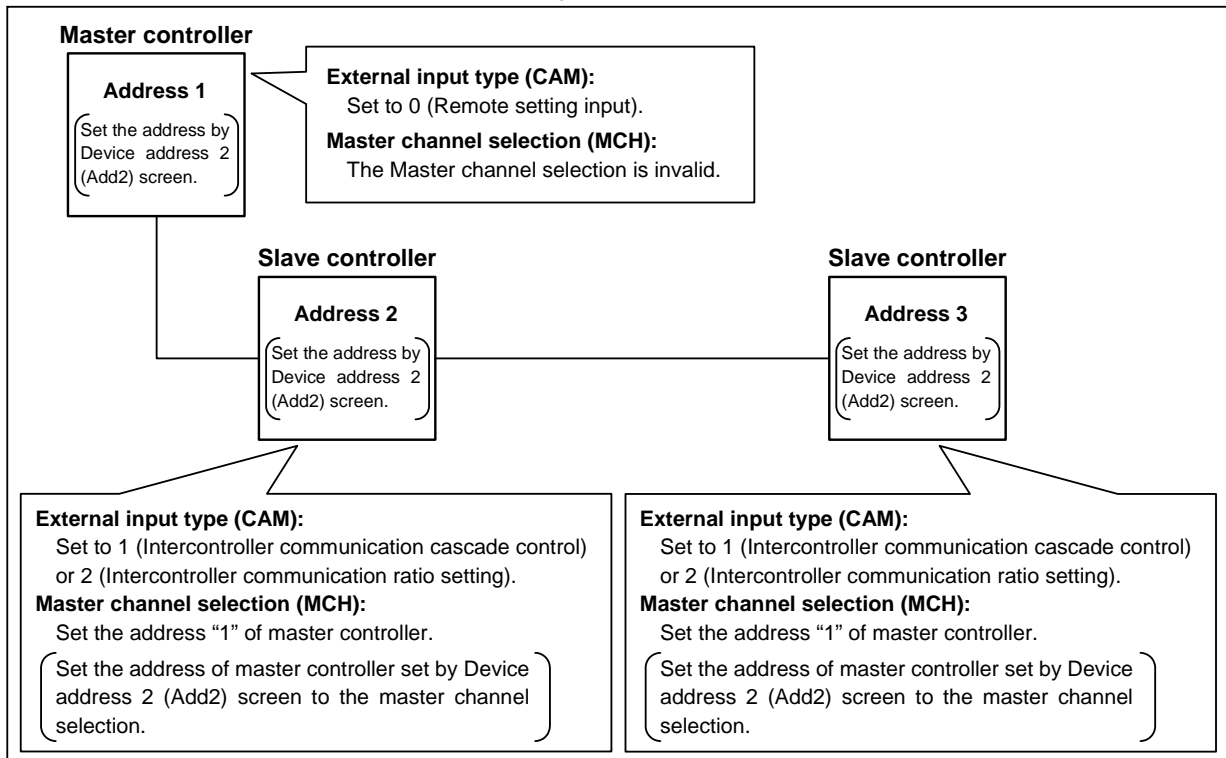

F50.

SV tracking

To select Use/Unuse of SV tracking.

Data range	Factory set value
0: Unused 1: Used	1

Related parameter

Operation mode:

- Remote/Local transfer (P. 7-18)

■ Description of function

With SV tracking function, when Remote/Local mode is transferred from Remote to Local, the set value used in Remote mode before the mode transfer will be kept using in Local mode to prevent rapid set value change.

Operation mode:	Local	→ Remote	→ Local
Set value used	Local set value	Remote set value	Local set value
SV tracking used	Local set value ≠ Remote set value	Local set value ≠ Remote set value	Local set value = Remote set value
SV tracking unused	Local set value ≠ Remote set value	Local set value ≠ Remote set value	Local set value ≠ Remote set value

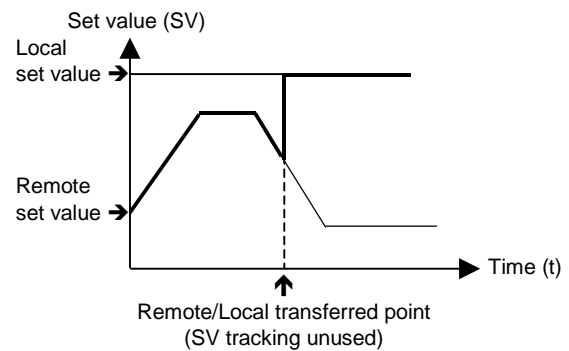
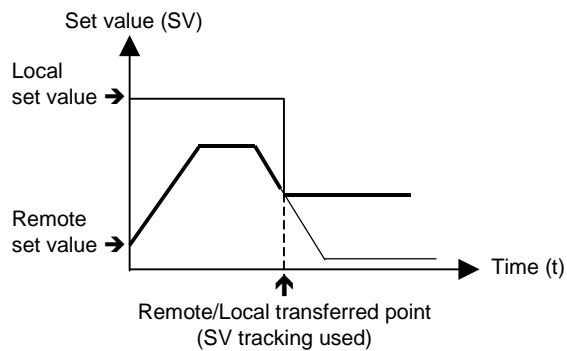

F50.

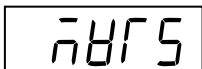
MV transfer function

The Manipulated output value used for manual control is selected when the Operation mode is changed to the Manual mode from the Auto mode.

Data range	Factory set value
0: Manipulated output value (MV1 or MV2) in Auto mode is used. [Balanceless/Bumpless function]	0 (Balanceless/Bumpless function)
1: When selected by Digital input (DI): Manipulated output value (MV1 or MV2) in previous Manual mode is used. [MV transfer function] When selected by front key: Manipulated output value (MV1 or MV2) in Auto mode is used. [Balanceless/Bumpless function]	
2: Manipulated output value (MV1 or MV2) in previous Manual mode is used. [MV transfer function]	

Related parameters

SV setting & monitor mode:

- Manipulated output value at MV transfer (P. 7-11)

Operation mode:

- Auto/Manual transfer (P. 7-17)

 For the Balanceless/bumpless function, refer to **6.7 Auto/Manual Transfer (P. 6-23)**.

F50.

PV transfer function

It is selected whether or not Measured value (PV) with the operation mode transferred to Auto mode from Manual mode is used as Set value (SV).

It is possible to prevent a Manipulated output value (MV) from its sudden change by substituting Measured value (PV) for Set value (SV).

Data range	Factory set value
0: Unused 1: Used	0

Related parameter

Operation mode:

- Auto/Manual transfer (P. 7-17)

Function block 51 (F51.)

F51.

This is the first parameter symbol of Function block 51 (F51.).

F51.

Control action

05

Use to select the action type of control.

Data range	Factory set value
0: Brilliant II PID control (direct action)	1
1: Brilliant II PID control (reverse action)	If the control action is specified by the model and suffix code when ordering, that control action becomes the factory set value.
2: Brilliant II Heat/Cool PID control [water cooling]	
3: Brilliant II Heat/Cool PID control [air cooling]	
4: Brilliant II Heat/Cool PID control [Cooling gain linear type]	
5: Brilliant II Position proportioning PID control (reverse action)	
6: Brilliant II Position proportioning PID control (direct action)	



With Output 2 (OUT2) optional, Heat/Cool PID control and Position proportioning PID control can be set.

■ Description of function

● PID control (direct action)

The Manipulated output value (MV) increases as the Measured value (PV) increases. This action is used generally for cool control.

● PID control (reverse action)

The Manipulated output value (MV) decreases as the Measured value (PV) increases. This action is used generally for heat control.

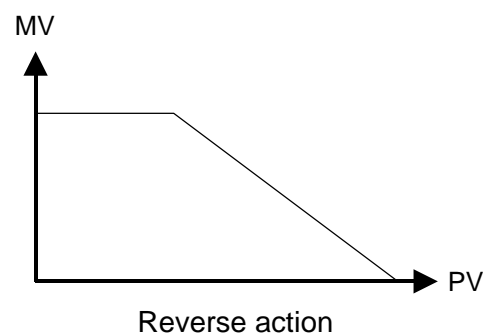
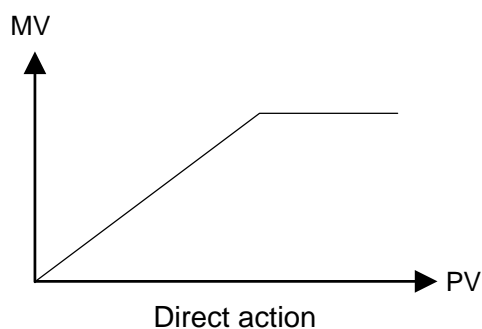

● **Heat/Cool PID control**

In Heat/Cool control, only one controller enables heat and cool control. For example, this is effective when cool control is required in extruder cylinder temperature control.

Water cooling/Air cooling: The algorithm assuming plastic molding machine Heat/Cool control is employed. Even in equipment provided with a cooling mechanism having nonlinear characteristics, it responds quickly to attain the characteristic responding to the set value with small overshooting.

Cooling gain linear type: The algorithm assuming applications without nonlinear cooling capability is employed.

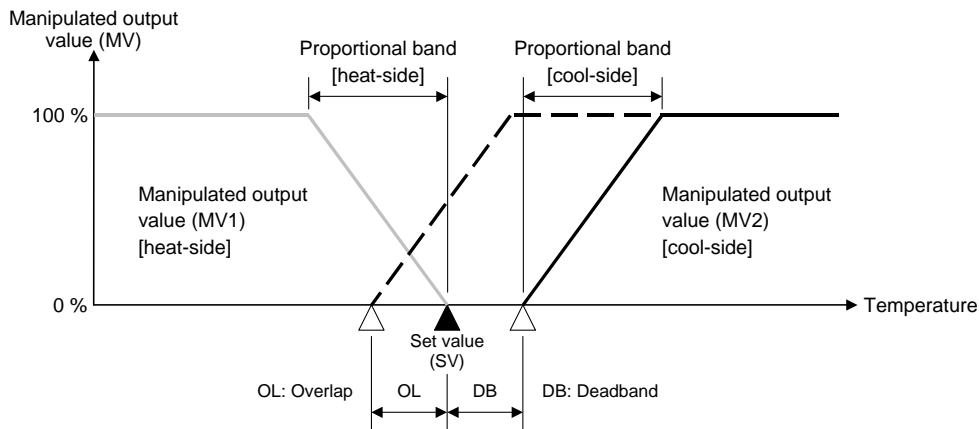

● **Position proportioning PID control**

Position proportioning PID control converts the control output value of the controller into the corresponding signal to control a motor driven valve (control motor) and then performs temperature control of a controlled object by regulating fluid flow. In Position proportioning PID control of this controller, it is possible to select the presence or absence of Feedback resistance (FBR) input which monitors the degree of valve opening (necessary to be selected when ordering). In addition, the direct action or reverse action can be selected.

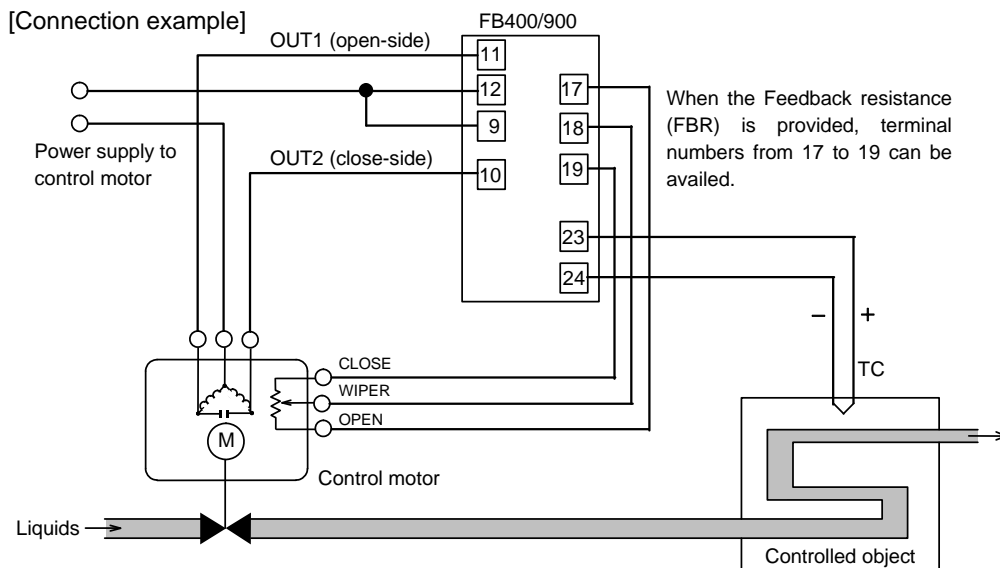

The details of setting differ depending on the presence or absence of Feedback resistance (FBR) input.

When the Feedback resistance (FBR) is provided:

- High/Low limit of valve position (limit value of FBR input) can be set.
[Output limiter high, Output limiter low]
- The valve position can be manually changed. [Manipulated output value (MV) setting in Manual mode]
- The feedback adjustment is necessary. [Feedback adjustment preparation]
- Action taken when Feedback resistance (FBR) input breaks can be selected.
[Action at Feedback resistance (FBR) input error]
- Output value (FBR input) with the output turned on or off when the Autotuning (AT) function is executed can be restricted. [Output value with AT turned on, Output value with AT turned off]
- The close-side (or open-side) output remains ON when the valve position is fully closed (or opened).
[Action at saturated output]

When the Feedback resistance (FBR) is not provided:

- Control motor operation can be restricted by the Integrated output limiter. [Integrated output limiter]
- The UP/DOWN key is used to output opening or closing signal in Manual mode.

UP key (open-side): While the UP key is being pressed, open-side output (OUT1) is output continuously. Releasing the UP key turns off the output on the open-side to hold the opened state at that time.

DOWN key (close-side): While the DOWN key is being pressed, close-side output (OUT2) is output continuously. Releasing the DOWN key turns off the output on the closed-side to hold the opened state at that time.

Parameter Valid/Invalid depending on the presence or absence of FBR input (×: Valid, -: Invalid)

Parameter (Engineering mode)	When the Feedback resistance (FBR) input is provided	When the Feedback resistance (FBR) input is not provided
Manipulated output value (MV1) at STOP mode	×	–
Output limiter high [MV1] Output limiter low [MV1]	×	–
Output value with AT turned on Output value with AT turned on	×	–
Open/Close output neutral zone *	×	×
Open/Close output differential gap *	×	×
Action at Feedback resistance (FBR) input error	×	–
Feedback adjustment	×	–
Control motor time *	×	×
Integrated output limiter	–	×
Valve action at STOP *	×	×
Action at saturated output	×	–

* Always set this item regardless of the presence or absence of opening Feedback resistance (FBR) input.



Position proportioning PID control can be performed if two output points are selected when ordering.



When the control action is the Position proportioning PID control, the Startup tuning (ST) is not available. In addition, the Output change rate limiter is invalid.



For the setting method of Position proportioning PID control, refer to **6.12 Position Proportioning PID Control (P. 6-40)**.

Brilliant II PID control

PID control is a control method of achieving stabilized control result by setting P (Proportional band), I (Integral time) and D (Derivative time) constants, and is widely used. However with this PID control if P, I and D values are set to focus on “better response to control set value change,” “response to external disturbance” deteriorates. In contrast, if PID values are set to focus on “better response to external disturbance,” “response to control set value change” deteriorates. In brilliant II PID control a form of “response to control set value change” can be selected from among **Fast**, **Medium** and **Slow** with PID constants remaining unchanged so as to be in good “response to external disturbance.” In addition, the controller is provided with the function which restricts the amount of undershooting caused by the cooling nonlinear characteristic possessed by plastic molding machines when the Set value (SV) is lowered in Heat/Cool PID control.

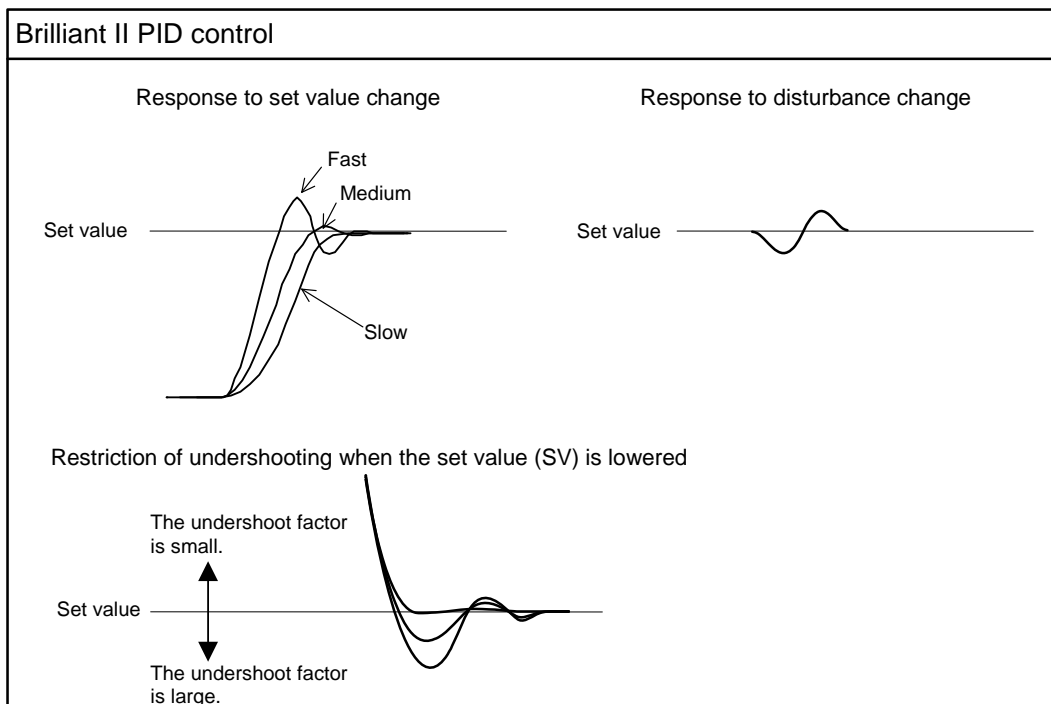
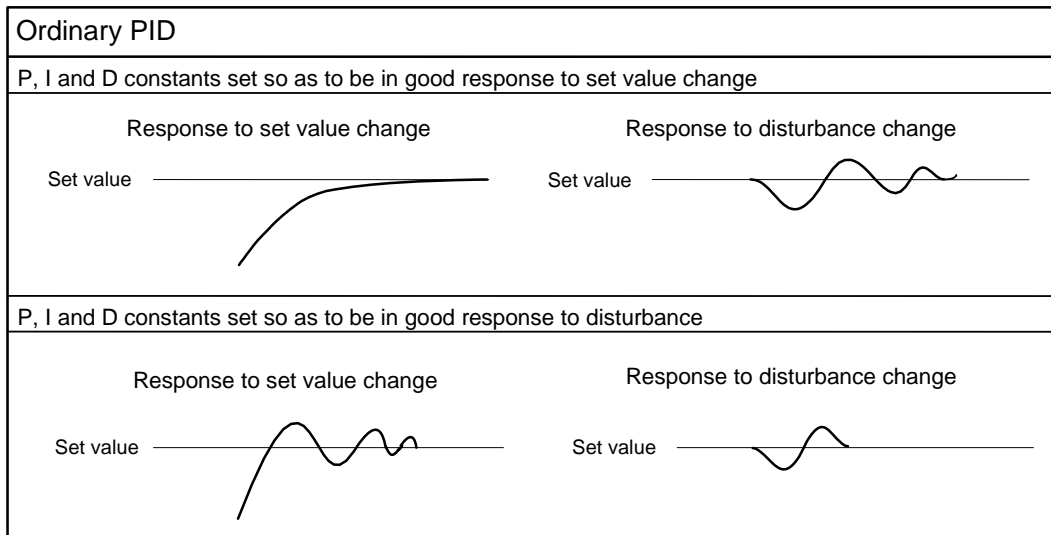

F51.

Integral/Derivative time decimal point position

Use to select a Decimal point position of Integral time and Derivative time.

Data range	Factory set value
0: 1 second setting (No decimal place)	0
1: 0.1 seconds setting (One decimal place)	

Related parameters

(Item whose position of the decimal point is automatically converted if the position of the decimal point is changed.)

Parameter setting mode:

- Integral time [heat-side] (P. 7-25)
- Integral time [cool-side] (P. 7-27)
- Derivative time [heat-side] (P. 7-25)
- Derivative time [cool-side] (P. 7-28)

Engineering mode:

- Integral time limiter (high) [heat-side] (P. 7-151)
- Integral time limiter (low) [heat-side] (P. 7-150)
- Derivative time limiter (high) [heat-side] (P. 7-152)
- Derivative time limiter (low) [heat-side] (P. 7-152)
- Integral time limiter (high) [cool-side] (P. 7-154)
- Integral time limiter (low) [cool-side] (P. 7-154)
- Derivative time limiter (high) [cool-side] (P. 7-155)
- Derivative time limiter (low) [cool-side] (P. 7-155)

F51.

Derivative gain

Use to set a gain used for the derivative action in PID control. Derivative gain should not be changed under ordinary operation.

Data range	Factory set value
0.1 to 10.0	6.0



Under ordinary operation, it is not necessary to change the factory set value.

Related parameters

Parameter setting mode:

- Derivative time [heat-side] (P. 7-25)
- Derivative time [cool-side] (P. 7-28)

Engineering mode:

- Derivative time limiter (high) [heat-side] (P. 7-152)
- Derivative time limiter (low) [heat-side] (P. 7-152)
- Derivative time limiter (high) [cool-side] (P. 7-155)
- Derivative time limiter (low) [cool-side] (P. 7-155)

F51.

ON/OFF action differential gap (upper)

ON/OFF action differential gap (lower)

oHH

ON/OFF action differential gap (upper):

Use to set the ON/OFF control differential gap (upper).

oHL

ON/OFF action differential gap (lower):

Use to set the ON/OFF control differential gap (lower).

Data range	Factory set value
TC/RTD inputs: 0 to Input span (Unit: °C [°F]) Varies with the setting of the Decimal point position (P. 7-71).	1
Voltage (V)/Current (I) inputs: 0.0 to 100.0 % or input span	0.1 % of input span

Related parameter

Parameter setting mode:

- Proportional band [heat-side] (P. 7-24)

Engineering mode:

- Decimal point position (P. 7-71)

■ Description of function

ON/OFF control is possible when the Proportional band is set to "0" or "0.0." In ON/OFF control with Reverse action, when the Measured value (PV) is smaller than the Set value (SV), the Manipulated output (MV) is 100 % or ON. When the PV is higher than the SV, the MV is 0 % or OFF.

Differential gap setting prevents control output from repeating ON and OFF too frequently.

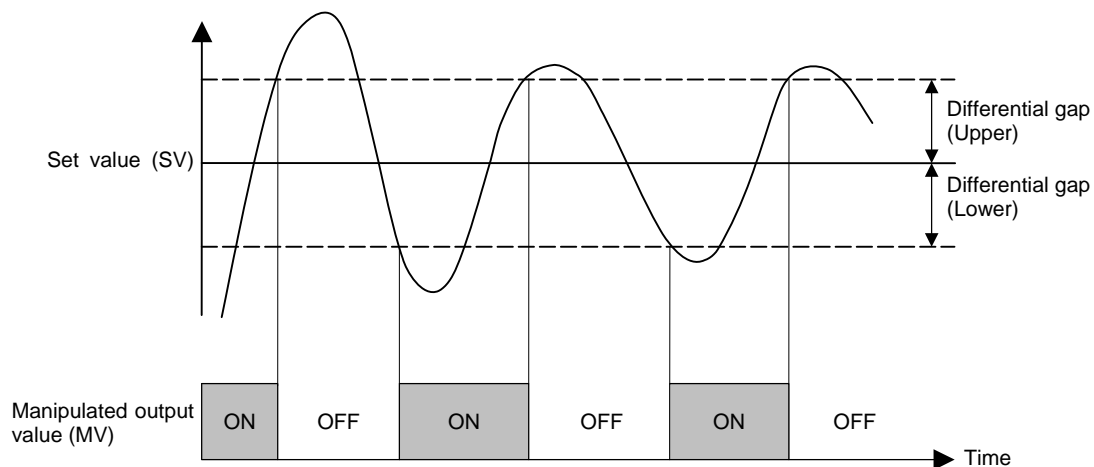

F51.

Action (high) at input error**Action (low) at input error**

A0HE

Action (high) at input error:

Use to select the action when the measured value reaches the Input error determination point (high).

A0LE

Action (low) at input error:

Use to select the action when the measured value reaches the Input error determination point (low).

Data range	Factory set value
0: Normal control	0
1: Manipulated output value at input error	

Related parameters

Engineering mode:

- Input error determination point (high),
Input error determination point (low) (P. 7-74)
- Manipulated output value at input error (P. 7-136)

■ Description of function**Input Error Determination:**

Example: Input range: 0 to 400 °C

Input error determination point (high): 300 °C

Input error determination point (low): 50 °C

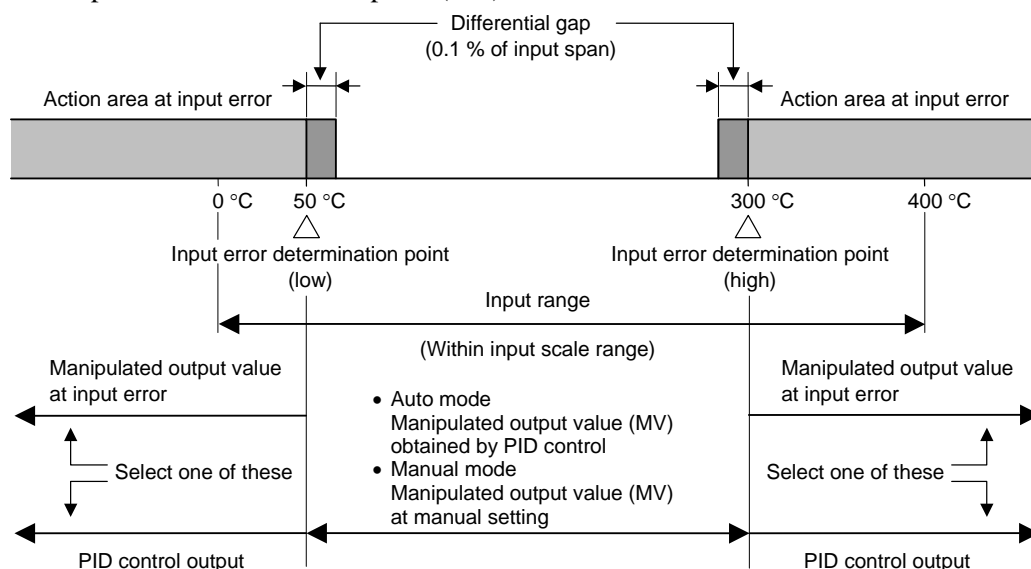
**[Manipulated output action at input error]**

• Auto mode

Selected to the Manual mode just when determined to be at input error to output the manipulated output value set by the Manipulated output value at input error.

• Manual mode

Not selected to the Manipulated output value at input error even if determined to be at input error.



When selected to RUN (control start) with any input error (burnout, etc.) occurring at STOP (control stop), not selected to the Manipulated output value at input error (both in Auto and Manual modes).

F51.

Manipulated output value at input error

When the measured value reaches Input error determination point and Action at input error is set to “1: Manipulated output value at input error,” this manipulated value is output.

Data range	Factory set value
-105.0 to +105.0 %	0.0



The actual output value becomes the value restricted by the Output limiter.



When the control action is the Position proportioning PID control:
When there is no Feedback resistance (FBR) input or the same input breaks, action taken at that time is in accordance with the Valve action setting at STOP.

Related parameters

Engineering mode:

- Action (high) at input error, Action (low) at input error (P. 7-135)
- Output limiter high (MV1), Output limiter low (MV1) (P. 7-138)
- Valve action at STOP (P. 7-162)

F51.

**Manipulated output value (MV1) at STOP mode
Manipulated output value (MV2) at STOP mode**

Manipulated output value to be output at STOP (control stop)

Data range	Factory set value
-5.0 to +105.0 %	-5.0



When the control action is the Position proportioning PID control:
Only when there is Feedback resistance (FBR) input and it does not break, the Manipulated output value (MV1) at STOP (mode) is output.

Related parameter

Operation mode:

- RUN/STOP transfer (P. 7-18)

F51.

Output change rate limiter (up) [MV1]**Output change rate limiter (down) [MV1]****Output change rate limiter (up) [MV2]****Output change rate limiter (down) [MV2]**

oru

Use to set the Output change rate limiter (up) to limit of the variation of output is set. Use to set the Output change rate limiter (down).

ord

Data range	Factory set value
0.0 to 100.0 %/second of manipulated output (0.0: OFF)	0.0

oru2



Invalid when the control action is the Position proportioning PID control.

ord2

Related parameters

Engineering mode:

- Output limiter high (MV1), Output limiter low (MV1),
Output limiter high (MV2), Output limiter low (MV2) (P. 7-138)

■ Description of function

The Output change rate limiter limits the variation of Manipulated output (MV) per second. This function is suitable for an application in which a sudden MV change is not acceptable.

Example: The Output change rate limiter is effective.

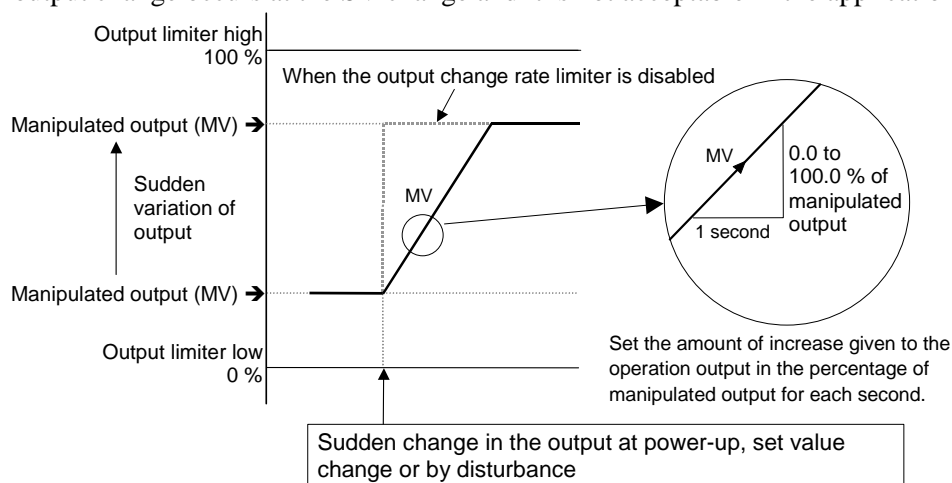

- The MV reaches 100 % when the power is turned on to the controller and such a sudden output change is not acceptable in the application.
- A sudden output change occurs at the SV change and it is not acceptable in the application.



The output changes at specific rates set by Output change rate limiter (up) even under the situations where a sudden output change would occur without Output change rate limiter function. There is also independent Output change rate limiter (down).

Continued on the next page.

Continued from the previous page.

-  If the output change rate is set smaller, it will cause slow control response and affect Derivative action.
-  When the Output change rate limiter is used, you may not be able to obtain appropriate PID constants by Autotuning.
-  The Output change rate limiter is particularly effective when a sudden MV change may create uncontrollable situation cause a large current flow. Also, it is very effective current output or voltage output is used as control output.

F51.

Output limiter high (MV1)

Output limiter low (MV1)

Output limiter high (MV2)

Output limiter low (MV2)

oLH

Output limiter high (MV1):

Use to set the high limit value of Manipulated output (MV1) [heat-side].

oLL

Output limiter low (MV1):

Use to set the low limit value of Manipulated output (MV1) [heat-side].

oLH2

Output limiter high (MV2):

Use to set the high limit value of Manipulated output (MV2) [cool-side].

oLL2

Output limiter low (MV2):

Use to set the low limit value of Manipulated output (MV2) [cool-side].

Data range	Factory set value
Output limiter high (MV1): Output limiter low (MV1) to 105.0 %	105.0
Output limiter high (MV2): Output limiter low (MV2) to 105.0 %	105.0
Output limiter low (MV1): -5.0 % to Output limiter high (MV1)	-5.0
Output limiter low (MV2): -5.0 % to Output limiter high (MV2)	-5.0



When the control action is the Position proportioning PID control:
Only when there is opening Feedback resistance (FBR) input and it does not break, the output limiter becomes valid.

Continued on the next page.

Continued from the previous page.

Related parameters

SV setting & monitor mode:

- Manipulated output value at MV transfer (P. 7-11)

Engineering mode:

- Manipulated output value at input error (P. 7-136)
- Output change rate limiter (up) [MV1],
Output change rate limiter (down) [MV1],
Output change rate limiter (up) [MV2],
Output change rate limiter (down) [MV2] (P. 7-137)
- Output value with AT turned on,
Output value with AT turned off (P. 7-148)

■ Description of function

This is the function which restricts the high and low limits of Manipulated output values (MV).

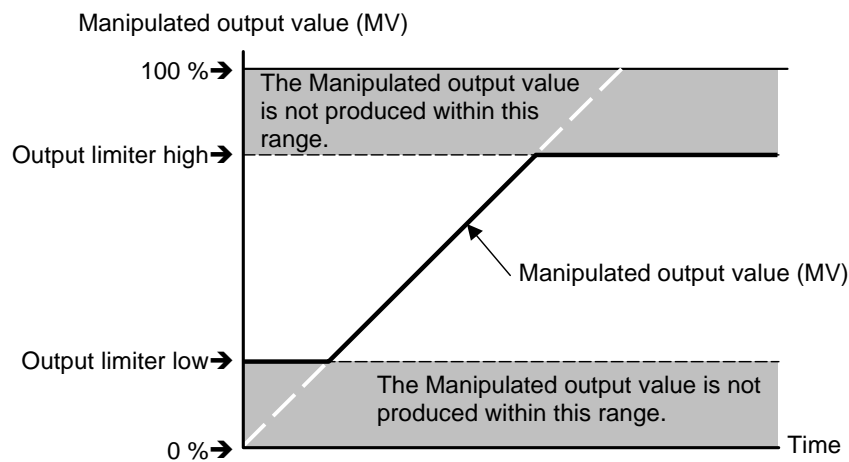

Output limiter is available for ON/OFF action.

F51.

Power feed forward selection

PPF input
OPTION

PPF

Use to select Use/Unuse of the Power feed forward (PPF) function.

Data range	Factory set value
0: Unused	1
1: Used	

Related parameter

Engineering mode:

- Power feed forward gain (P. 7-141)

■ Description of function

The Power feed forward function monitors the electrical load through a dedicated transformer, and adjusts manipulated output to compensate power supply fluctuation. If the power feed forward (PPF) input voltage is decreased by about 30 % of the rated value, the Power feed forward function is turned off. At this time, the control mode will return to the normal control (the same control as without the Power feed forward function).

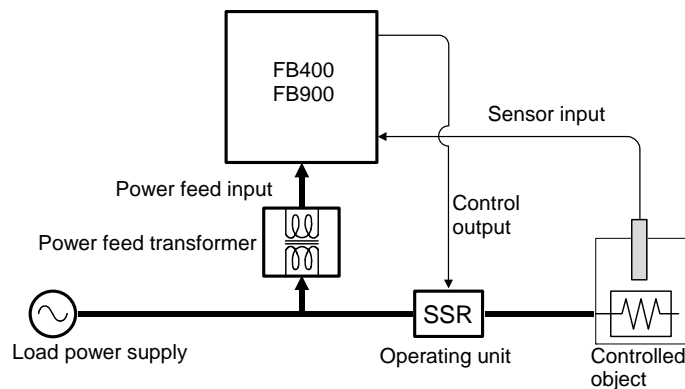

The Power feed forward function is used together with the Output change rate limiter function, the Manipulated output value may exceed the limit of the Output change rate limiter.

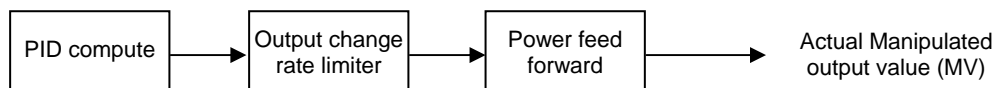

Relationship between the Power feed forward and Output change rate limiter



When the Power feed forward function is set to “1: Used,” the function is turned off under the following condition.

- **When no Power feed forward (PPF) input is used (no Power feed transformer is connected)**
- **When Power feed forward (PPF) input voltage is decreased by about 30 % of the rated value**



This parameter applies only to instruments specified with the Power feed forward function (optional) when ordered.



Always use the dedicated power feed transformer included.

F51.

Power feed forward gain

PFF5

Use to set a gain used for the Power feed forward (PFF) function.

Power feed forward gain should not be changed under ordinary operation.

Data range	Factory set value
0.01 to 5.00	1.00



Under ordinary operation, it is not necessary to change Power feed forward gain set value.

Related parameter

Engineering mode:

- Power feed forward selection (P. 7-140)

■ Description of function

Power supply voltage variations may give disturbances to the controlled temperature as they make an effect on external devices other than heaters.

If in such a case, control stability can be maintained by adjusting the Power feed forward gain.

Usually, the instrument is used at a gain of 1.00.



This parameter applies only to instruments specified with the Power feed forward function (optional) when ordered.

F51.

Derivative action



Use to select the action of derivative term.

Data range	Factory set value
0: Measured value derivative	0
1: Deviation derivative	



In Position proportioning PID control, action becomes Measured value derivative regardless of the setting.

Related parameter

Operation mode:

- PID/AT transfer (P. 7-15)

■ Description of function

Measured value derivative: PID control putting much emphasis on response most adaptive to fixed set point control (mode)

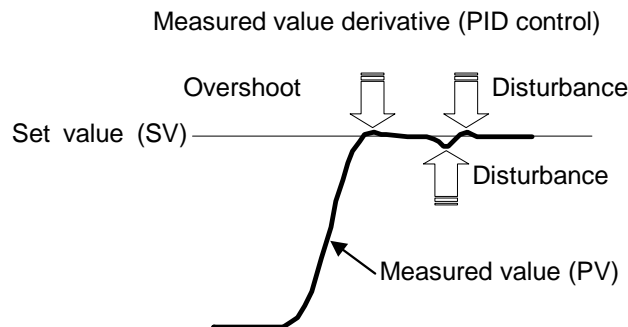

Deviation derivative:

PID control putting much emphasis on follow-up most adaptive to ramp control or cascade control using a ratio of setting change limiter, etc. It is effective to follow-up at powering up a load or restrict the amount of overshooting when changed to Soak from Ramp.

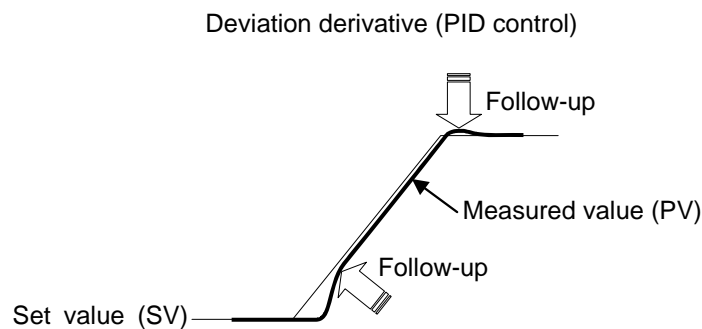

F51.

Undershoot suppression factor

US

This is a factor to suppress undershoot on the cool side.

Data range	Factory set value
0.000 to 1.000	Water cooling: 0.100 Air cooling: 0.250 Cooling gain linear type: 1.000



The Undershoot suppression factor is invalid even if set when control is not in Heat/Cool PID control.

Related parameter

Engineering mode:

- Control action (P. 7-129)

■ Description of function

The Undershoot suppression function suppresses the undershoot that occurs when the Set value (SV) is lowered due to the special cooling characteristic (cooling nonlinear characteristic) of plastic molding machines. The undershoot suppression effect increases as a smaller value is set for the Undershoot suppression factor.

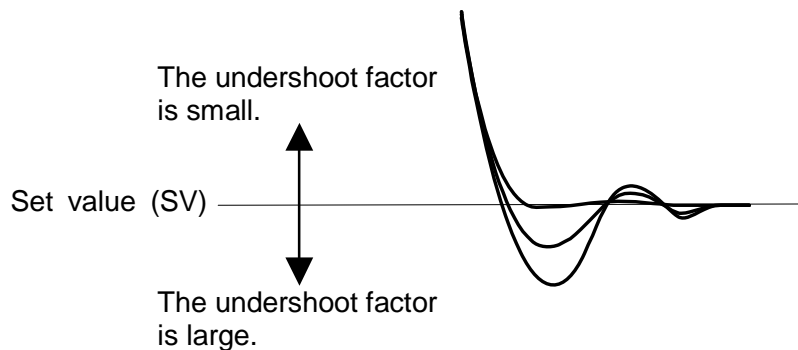

If the Undershoot suppression factor is set too small, the undershoot function acts excessively and prevents the Measured value (PV) from reaching the Set value (SV). As a result, the PV stabilizes at an offset or approaches the set value very slowly, preventing normal control.

In this event, change the setting for the Undershoot suppression factor to a slightly higher value.

F51.

Overlap/Deadband reference point

dbPA

Adjust the Overlap/Deadband reference point at Heat/Cool PID control.

Data range	Factory set value
0.0 to 1.0	0.0



Overlap/Deadband reference point can only be adjusted when the control method is Heat/Cool PID control.

Related parameter

Parameter setting mode:

- Proportional band [heat-side] (P. 7-24)
- Proportional band [cool-side] (P. 7-27)
- Overlap/Deadband (P. 7-29)

Engineering mode:

- Control action (P. 7-129)

■ Description of function

Each Set value (SV) for the Heat/Cool PID control becomes the Overlap/Deadband reference point.

- When setting 0.0, Overlap/Deadband reference point is at 0 % of the output at Proportional band [heat-side].
- When setting 0.5, Overlap/Deadband reference point is at the midpoint of the Overlap/Deadband.
- When setting 1.0, Overlap/Deadband reference point is at 0 % of the output at Proportional band [cool-side].

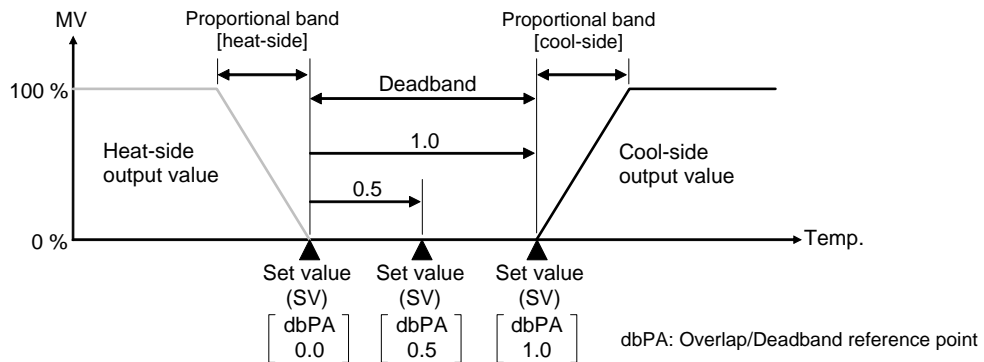

Example: Difference in Overlap/Deadband reference point

[Overlap/Deadband reference point: 0.0]

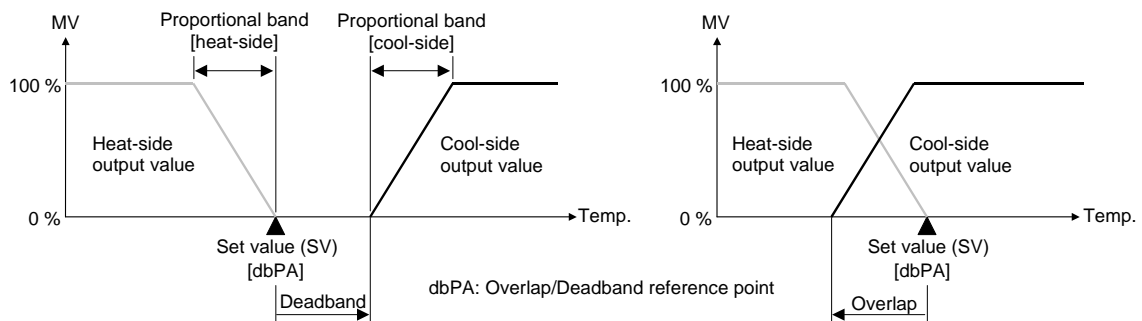

[Overlap/Deadband reference point: 0.5]

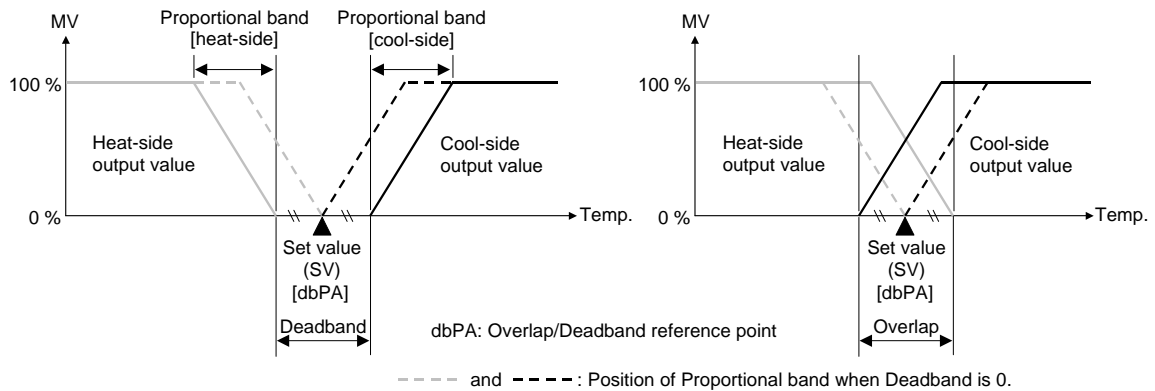

[Overlap/Deadband reference point: 1.0]

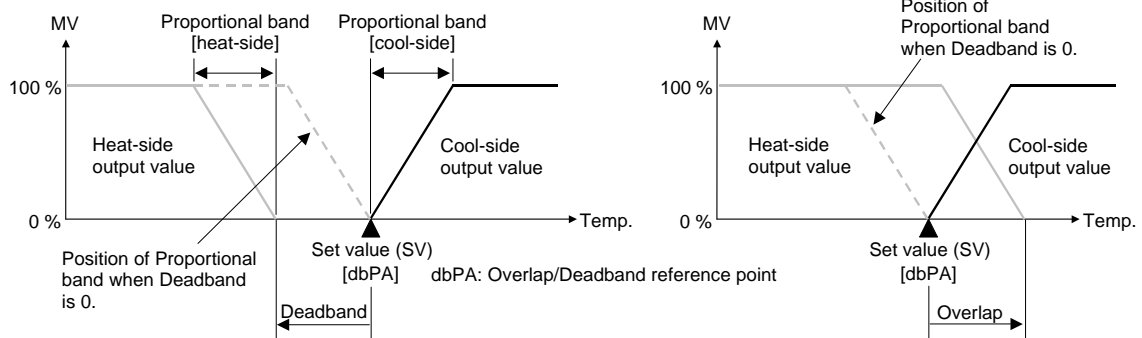

To change Deadband when the Overlap/Deadband reference point is 0.5, the Proportional band on heat-side and cool-side shift equidistantly to the midpoint of the Overlap/Deadband.

Function block 52 (F52.)

F52.

This is the first parameter symbol of Function block 52 (F52.).

F52.

AT bias

ATb

Use to set a bias to move the set value only when Autotuning (AT) is activated.

Data range	Factory set value
–Input span to +Input span Varies with the setting of the Decimal point position (P. 7-71).	0

Related parameter

Operation mode:

- PID/AT transfer (P. 7-15)

Engineering mode:

- Decimal point position (P. 7-71)

■ Description of function

The AT bias is used to prevent overshoot during Autotuning in the application which does not allow overshoot even during Autotuning. RKC Autotuning method uses ON/OFF control at the set value to compute the PID values. However, if overshoot is a concern during Autotuning, the desired AT bias should be set to lower the set point during Autotuning so that overshoot is prevented.

[Example] When AT bias is set to the minus (–) side.

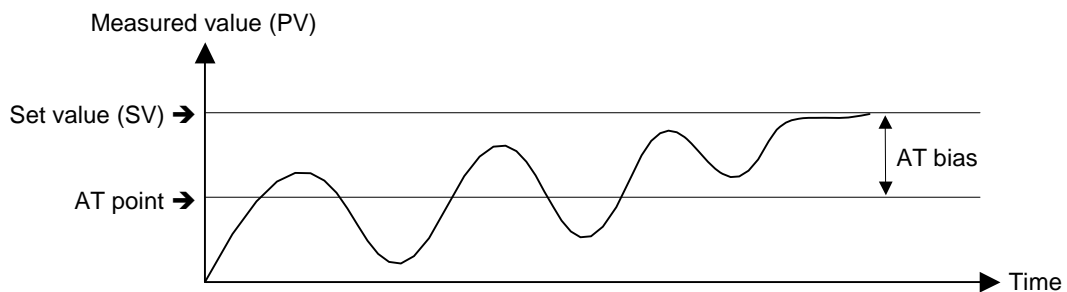

F52.

AT cycles



The number of ON/OFF cycles is selected when the Autotuning (AT) function is executed.

Data range	Factory set value
0: 1.5 cycles	1
1: 2.0 cycles	
2: 2.5 cycles	
3: 3.0 cycles	

Related parameter

Operation mode:

- PID/AT transfer (P. 7-15)

■ Example

When the AT cycle is set to 1.5 cycle and the Autotuning (AT) function is executed just after the power is turned on.

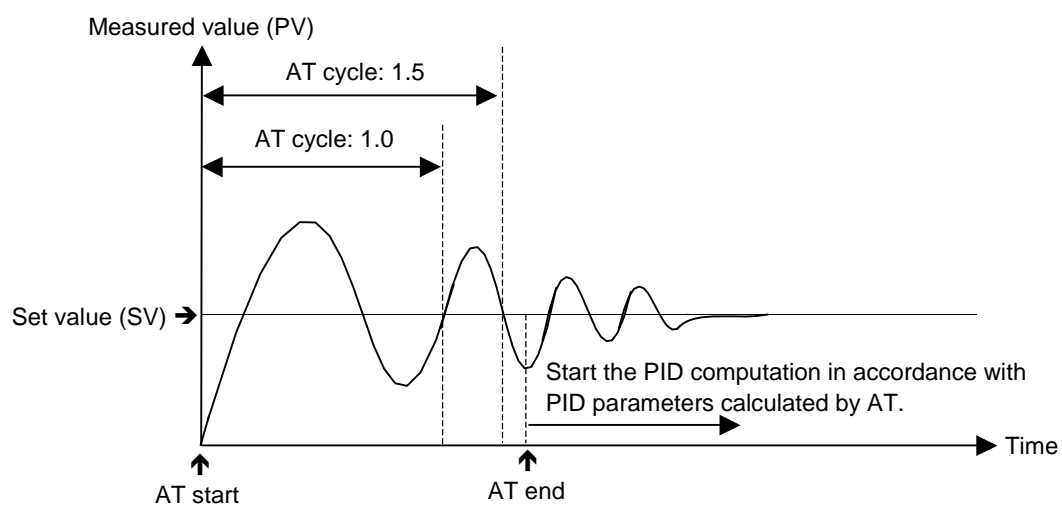

F52.

AT differential gap time



Use to set an ON/OFF action differential gap time for Autotuning (AT). This function prevents the AT function from malfunctioning caused by noise.

Data range	Factory set value
0.0 to 50.0 seconds	10.0

Related parameter

Operation mode:

- PID/AT transfer (P. 7-15)

■ Description of function

In order to prevent the output from chattering due to the fluctuation of a Measured value (PV) caused by noise during Autotuning, the output on or off state is held until AT differential gap time has passed after the output on/off state is changed to the other.

Set AT differential gap time to “ $1/100 \times$ Time required for temperature rise.”

[Example]

A: AT cycle time when the AT differential gap time is set to 0.0 second

The output chatters due to the fluctuation of the Measured value (PV) caused by noise, and Autotuning (AT) function is not able to monitor appropriate cycles to compute suitable PID values.

B: AT cycle time when the AT differential gap time is set to “Time corresponding to 0.25 cycles.”

The fluctuation of a Measured value (PV) caused by noise is ignored and as a result Autotuning (AT) function is able to monitor appropriate cycles to compute suitable PID values.

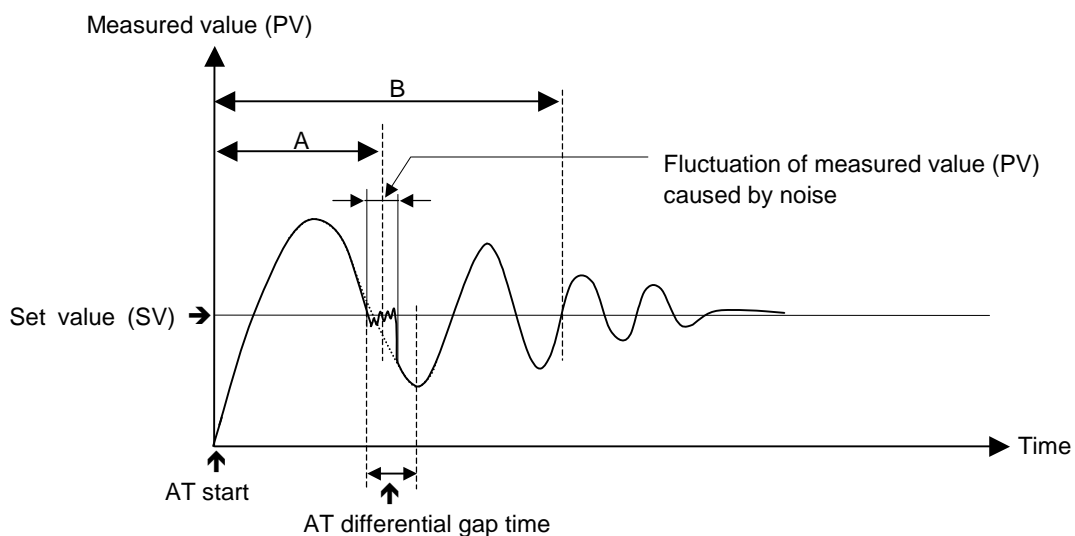

The factory set value of the AT cycle is 2 cycles.

F52.

Output value with AT turned on**Output value with AT turned off**

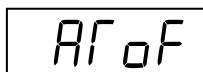

Output value with AT turned on:

This parameter is for limiting the Manipulated output value (ON side) while the Autotuning (AT) function is being executed.

Output value with AT turned off:

This parameter is for limiting the Manipulated output value (OFF side) while the Autotuning (AT) function is being executed.

Data range	Factory set value
Output value with AT turned on: Output value with AT turned off to +105.0 %	105.0
Output value with AT turned off: -105.0 % to Output value with AT turned on	-105.0

 The actual output value becomes the value restricted by the output limiter.

 When the control action is the Position proportioning PID control:
Only when there is Feedback resistance (FBR) input and it does not break, the output value with AT turned on or output value with AT turned off becomes valid.

Output value with AT turned on:

High limit value for Feedback resistance input while the Autotuning (AT) function is being executed

Output value with AT turned off:

Low limit value for Feedback resistance input while the Autotuning (AT) function is being executed

Related parameters

Operation mode:

- PID/AT transfer (P. 7-15)

Engineering mode:

- Output limiter high (MV1), Output limiter low (MV1),
Output limiter high (MV2), Output limiter low (MV2) (P. 7-138)

■ Plus (+)/Minus (-) setting when in Heat/Cool PID control

Set the output value with AT turned on to a plus (+) value.	Output value with the heat-side turned on = Output value with AT turned on Output value with the heat-side turned off = Output limiter low (MV1) [heat-side]
Set the output value with AT turned off to a minus (-) value.	Output value with the cool-side turned on = Output value with AT turned off Output value with the cool-side turned off = Output limiter low (MV2) [cool-side]
Set the output values with AT turned on and off to plus (+) values.	The Autotuning (AT) function is executed only on the heat-side. Output value with the heat-side turned on = Output value with AT turned on Output value with the heat-side turned off = Output value with AT turned off (Output value with AT turned on > Output value with AT turned off)
Set the output values with AT turned on and off to minus (-) values.	The Autotuning (AT) function is executed only on the cool-side. Output value with the cool-side turned on = Output value with AT turned off Output value with the cool-side turned off = Output value with AT turned on (Output value with AT turned on > Output value with AT turned off)

F52.

Proportional band limiter (high) [heat-side]**Proportional band limiter (low) [heat-side]**

PLH

Proportional band limiter (high) [heat-side]:

Use to set the high limit value of Proportional band [heat-side].

PLL

Proportional band limiter (low) [heat-side]:

Use to set the low limit value of Proportional band [heat-side].

The Proportional band [heat-side] range is restricted while the Startup tuning (ST) and Autotuning (AT) functions are being executed.

Data range	Factory set value
TC/RTD inputs: 0 (0.0, 0.00) to Input span (Unit: °C [°F]) Varies with the setting of the Decimal point position (P. 7-71).	Proportional band limiter (high): Input span Proportional band limiter (low): 0 (0.0, 0.00)
Voltage (V)/Current (I) inputs: 0.0 to 1000.0 % of input span	Proportional band limiter (high): 1000.0 % Proportional band limiter (low): 0.0 %

Related parameters

Operation mode:

- PID/AT transfer (P. 7-15)
- Startup tuning (ST) (P. 7-16)

Parameter setting mode:

- Proportional band [heat-side] (P. 7-24)

Engineering mode:

- Decimal point position (P. 7-71)

F52.

Integral time limiter (high) [heat-side]**Integral time limiter (low) [heat-side]**

Integral time limiter (high) [heat-side]:

Use to set the high limit value of Integral time [heat-side].

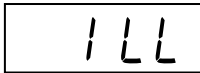



Integral time limiter (low) [heat-side]:

Use to set the low limit value of Integral time [heat-side].

The Integral time [heat-side] range is restricted while the Startup tuning (ST) and Autotuning (AT) functions are being executed.

Data range	Factory set value
0 to 3600 seconds or 0.0 to 1999.9 seconds	Integral time limiter (high): 3600 Integral time limiter (low): 0

 The Decimal point position for data differs depending on the Integral/Derivative time decimal point position.

 If the Autotuning (AT) function is executed when the Integral time limiter (high) [heat-side] is set at “0” or “0.0,” P and D values suitable to PD control (heat-side) are computed (excluding the Position proportioning PID control).

Related parameters

Operation mode:

- PID/AT transfer (P. 7-15)
- Startup tuning (ST) (P. 7-16)

Parameter setting mode:

- Integral time [heat-side] (P. 7-25)

Engineering mode:

- Integral/Derivative time decimal point position (P. 7-133)

F52.

Derivative time limiter (high) [heat-side]**Derivative time limiter (low) [heat-side]**

dLH

Derivative time limiter (high) [heat-side]:

Use to set the high limit value of Derivative time [heat-side].

dLL

Derivative time limiter (low) [heat-side]:

Use to set the low limit value of Derivative time [heat-side].

The Derivative time [heat-side] range is restricted while the Startup tuning (ST) and Autotuning (AT) functions are being executed.

Data range	Factory set value
0 to 3600 seconds or 0.0 to 1999.9 seconds	Derivative time limiter (high): 3600 Derivative time limiter (low): 0



The Decimal point position for data differs depending on the Integral/Derivative time decimal point position.



If the Autotuning (AT) function is executed when the Derivative time limiter (high) [heat-side] is set at "0" or "0.0," P and I values suitable to PI control (heat-side) are computed.

Related parameters

Operation mode:

- PID/AT transfer (P. 7-15)
- Startup tuning (ST) (P. 7-16)

Parameter setting mode:

- Derivative time [heat-side] (P. 7-25)

Engineering mode:

- Integral/Derivative time decimal point position (P. 7-133)

F52.

Proportional band limiter (high) [cool-side]**Proportional band limiter (low) [cool-side]****P_{cLH}**

Proportional band limiter (high) [cool-side]:

Use to set the high limit value of Proportional band [cool-side].

P_{cLL}

Proportional band limiter (low) [cool-side]:

Use to set the low limit value of Proportional band [cool-side].

The Proportional band [cool-side] range is restricted while the Autotuning (AT) function is being executed.

Data range	Factory set value
TC/RTD inputs: 1 (0.1, 0.01) to Input span (Unit: °C [°F]) Varies with the setting of the Decimal point position (P. 7-71).	Proportional band limiter (high): Input span Proportional band limiter (low): 1 (0.1, 0.01)
Voltage (V)/Current (I) inputs: 0.1 to 1000.0 % of input span	Proportional band limiter (high): 1000.0 % Proportional band limiter (low): 0.1 %



The Proportional band limiter (high) [cool-side] and Proportional band limiter (low) [cool-side] are valid only during Heat/Cool PID control.

Related parameters

Operation mode:

- PID/AT transfer (P. 7-15)

Parameter setting mode:

- Proportional band [cool-side] (P. 7-27)

Engineering mode:

- Decimal point position (P. 7-71)

F52.

Integral time limiter (high) [cool-side]**Integral time limiter (low) [cool-side]**

I cLH

Integral time limiter (high) [cool-side]:

Use to set the high limit value of Integral time [cool-side].



I cLL

Integral time limiter (low) [cool-side]:

Use to set the low limit value of Integral time [cool-side].

The Integral time [cool-side] range is restricted while the Autotuning (AT) function is being executed.

Data range	Factory set value
0 to 3600 seconds or 0.0 to 1999.9 seconds	Integral time limiter (high): 3600 Integral time limiter (low): 0

-  The Decimal point position for data differs depending on the Integral/Derivative time decimal point position.
-  If the Autotuning (AT) function is executed when the Integral time limiter (high) [cool-side] is set at "0" or "0.0," P and D values suitable to PD control (cool-side) are computed.
-  The Integral time limiter (high) [cool-side] and Integral time limiter (low) [cool-side] are valid only during Heat/Cool PID control.

Related parameters

Operation mode:

- PID/AT transfer (P. 7-15)

Parameter setting mode:

- Integral time [cool-side] (P. 7-27)

Engineering mode:

- Integral/Derivative time decimal point position (P. 7-133)

F52.

Derivative time limiter (high) [cool-side]**Derivative time limiter (low) [cool-side]**

dcLH

Derivative time limiter (high) [cool-side]:

Use to set the high limit value of Derivative time [cool-side].

dcLL

Derivative time limiter (low) [cool-side]:

Use to set the low limit value of Derivative time [cool-side].

The Derivative time [cool-side] range is restricted while the Autotuning (AT) function is being executed.

Data range	Factory set value
0 to 3600 seconds or 0.0 to 1999.9 seconds	Derivative time limiter (high): 3600 Derivative time limiter (low): 0

 The Decimal point position for data differs depending on the Integral/Derivative time decimal point position.

 If the Autotuning (AT) function is executed when the Derivative time limiter (high) [cool-side] is set at "0" or "0.0," P and I values suitable to PI control (cool-side) are computed.

 The Derivative time limiter (high) [cool-side] and Derivative time limiter (low) [cool-side] are valid only during Heat/Cool PID control.

Related parameters

Operation mode:

- PID/AT transfer (P. 7-15)

Parameter setting mode:

- Derivative time [cool-side] (P. 7-28)

Engineering mode:

- Integral/Derivative time decimal point position (P. 7-133)

F52.

Proportional band adjusting factor [heat-side]**Proportional band adjusting factor [cool-side]**

PAJ

PcAJ

Proportional band adjusting factor [heat-side]:

This is a factor which is multiplied by the Proportional band [heat-side] computed by executing the Autotuning (AT) function.

Proportional band adjusting factor [cool-side]:

This is a factor which is multiplied by the Proportional band [cool-side] computed by executing the Autotuning (AT) function.

Data range	Factory set value
0.01 to 10.00 times	1.00



The Proportional band adjusting factor [cool-side] is valid only during Heat/Cool PID control.

Related parameters

Operation mode:

- PID/AT transfer (P. 7-15)

Parameter setting mode:

- Proportional band [heat-side] (P. 7-24)
- Proportional band [cool-side] (P. 7-27)

F52.

Integral time adjusting factor [heat-side]**Integral time adjusting factor [cool-side]**

IAJ

IcAJ

Integral time adjusting factor [heat-side]:

This is a factor which is multiplied by the Integral time [heat-side] computed by executing the Autotuning (AT) function.

Integral time adjusting factor [cool-side]:

This is a factor which is multiplied by the Integral time [cool-side] computed by executing the Autotuning (AT) function.

Data range	Factory set value
0.01 to 10.00 times	1.00



The Integral time adjusting factor [cool-side] is valid only during Heat/Cool PID control.

Related parameters

Operation mode:

- PID/AT transfer (P. 7-15)

Parameter setting mode:

- Integral time [heat-side] (P. 7-25)
- Integral time [cool-side] (P. 7-27)

F52.

Derivative time adjusting factor [heat-side]**Derivative time adjusting factor [cool-side]**

dAu

Derivative time adjusting factor [heat-side]:

This is a factor which is multiplied by the Derivative time [heat-side] computed by executing the Autotuning (AT) function.

dcAu

Derivative time adjusting factor [cool-side]:

This is a factor which is multiplied by the Derivative time [cool-side] computed by executing the Autotuning (AT) function.

Data range	Factory set value
0.01 to 10.00 times	1.00



The Derivative time adjusting factor [cool-side] is valid only during Heat/Cool PID control.

Related parameters

Operation mode:

- PID/AT transfer (P. 7-15)

Parameter setting mode:

- Derivative time [heat-side] (P. 7-25)
- Derivative time [cool-side] (P. 7-28)

Function block 53 (F53.)

F53.

This is the first parameter symbol of Function block 53 (F53.).

Only when Position proportioning PID control is selected, the parameters in this block are valid.

In addition, if no Feedback resistance (FBR) input is specified when ordering, there are parameters which will become invalid even when set.

F53.

Open/Close output neutral zone

ydb

Use to set Open/Close output neutral zone.

Data range	Factory set value
0.1 to 10.0 % of output	2.0

Related parameters

Engineering mode:

- Open/Close output differential gap (P. 7-159)
- Action at feedback resistance (FBR) input error (P. 7-159)
- Feedback adjustment (P. 7-160)

■ Description of function

The neutral zone is used to prevent a control motor from repeating ON/OFF too frequently. When the PID computed output value is within the neutral zone, the controller will not output the MV to a control motor.

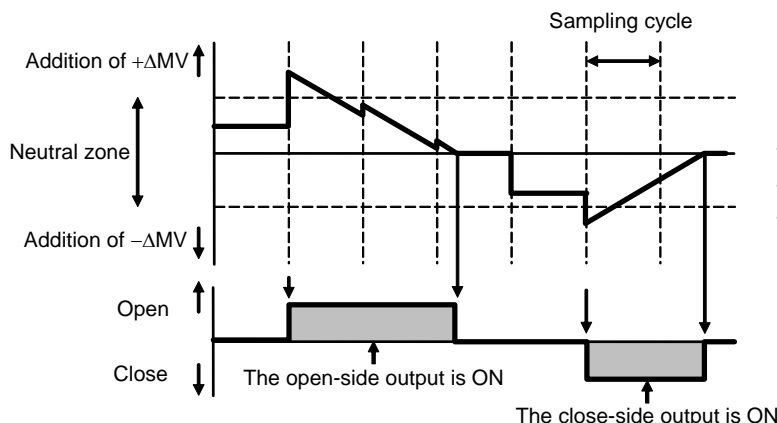

The controller does not output the ΔMV to a control motor when the PID computed output value is within the neutral zone.

F53.

Open/Close output differential gap

445

Use to set differential gap of Open/Close output used in the Position proportioning PID control.

Data range	Factory set value
0.1 to 5.0 % of output	1.0

Related parameters

Engineering mode:

- Open/Close output neutral zone (P. 7-158)
- Action at feedback resistance (FBR) input error (P. 7-159)
- Feedback adjustment (P. 7-160)

■ Description of function

The Open/Close output differential gap prevents output ON/OFF chattering caused by fluctuation of feedback resistance input.

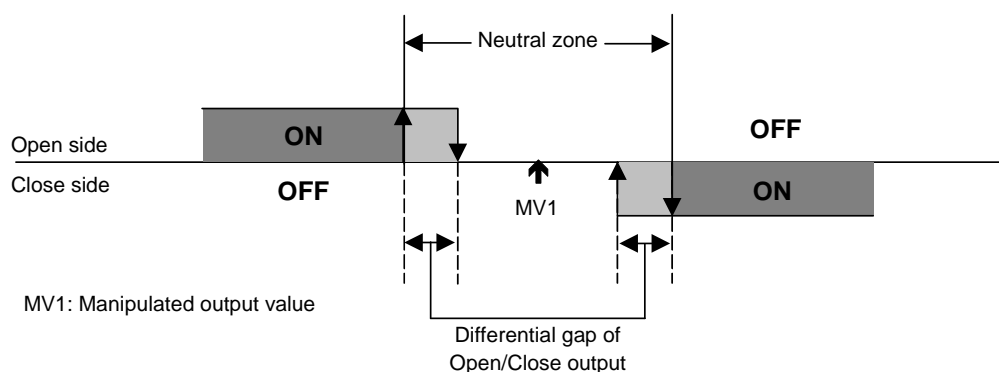

F53.

Action at Feedback resistance (FBR) input error

FBR
input
OPTION

46r

Use to select an action at the Feedback resistance (FBR) input break.

Data range	Factory set value
0: Action depending on the value action at STOP	0
1: Control action continued	

Related parameters

Engineering mode:

- Open/Close output neutral zone (P. 7-158)
- Open/Close output differential gap (P. 7-159)
- Feedback adjustment (P. 7-160)
- Valve action at STOP (P. 7-162)

F53.

Feedback adjustment



P05

Feedback adjustment function is to adjust controller's output value to match the Feedback resistance (FBR) of the control motor.

After the adjustment, the Manipulated output value of 0 to 100 % obtained after PID computation matches the valve position signal of the fully closed position to the fully opened position [Feedback resistance (FBR) input] sent from the control motor. The adjustment have to be completed before starting operation.

Always make sure that the wiring is correct and the control motor operates normally before the adjustment. (Refer to P. 7-130)

In addition, if opening adjustment is performed, the control motor time is automatically computed. However, if the time thus computed is less than 5 seconds, no set value is updated.

Data range	Factory set value
0 (AdJ): Adjustment end	—
1 (oPn): During adjustment on the open-side	
2 (CLS): During adjustment on the close-side	

■ Adjustment procedure

At the Adjustment preparation screen, press the shift key for 5 seconds to start the adjustment.

The display automatically returns to the Adjustment Preparation screen after the adjustment is completed.

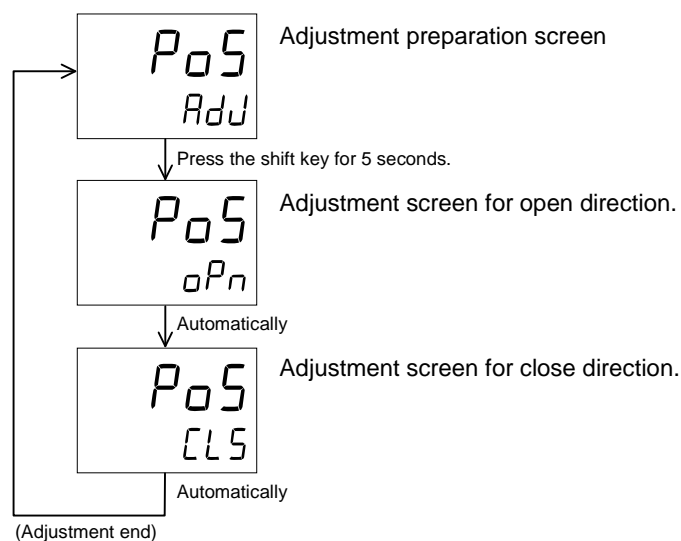

Display returns to the PV/SV monitor screen if no key operation is performed within 1 minute (except during the feedback adjustment).

F53.

Control motor time

This is the time required until the control motor is fully opened from its fully closed state.

Data range	Factory set value
5 to 1000 seconds	10

If opening adjustment is performed, the Control motor time is automatically computed. However, if the time thus computed is less than 5 seconds, no set value is updated.

Related parameter

Engineering mode:

- Integrated output limiter (P. 7-161)

F53.

Integrated output limiter

This is a restricted value when the output on the open or closed side is integrated. If the output on the open (or closed) side is output in succession, it is integrated and if the result reaches the Integrated output limiter value, the output on the open (or closed) side is turned off. In addition, if the output on the open (or closed) side is reversed, the integrated value is reset.

Data range	Factory set value
0.0 to 200.0 % of control motor time (0.0: Integrated output limiter function OFF)	150.0

The Integrated output limiter is invalid when the Feedback resistance (FBR) input was used.

Related parameter

Engineering mode:

- Control motor time (P. 7-161)

■ Setting example

If control is started at the fully closed state when the control motor time is set at 10 seconds and the Integrated output limiter value is set at 100 %, the following results.

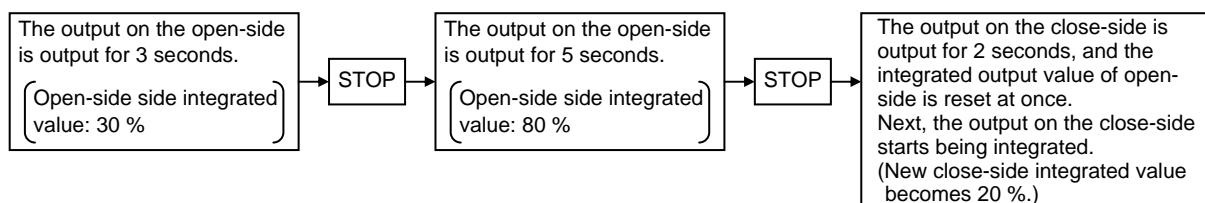

F53.

Valve action at STOP

Select the valve action when Feedback resistance (FBR) input is disabled or “0 (Action depending on the value action setting at STOP)” is set for the action when a Feedback resistance (FBR) input break occurs.

Data range	Factory set value
0: Close-side output OFF, Open-side output OFF 1: Close-side output ON, Open-side output OFF 2: Close-side output OFF, Open-side output ON	0

Related parameter

Engineering mode:

- Action at Feedback resistance (FBR) input error (P. 7-159)

F53.

Action at saturated output



Set to maintain ON state for the close-side (or open-side) output when the valve position is fully closed (or opened).

Data range	Factory set value
0: Invalid (The close-side [or open-side] output turns to OFF when the valve position is fully closed [or opened]). 1: Valid (The close-side [or open-side] output remains ON state when the valve position is fully closed [or opened]).	0

Related parameter

Engineering mode:

- Action at Feedback resistance (FBR) input error (P. 7-159)

■ Description of function**[When the Action at saturated output is invalid]**

The close-side output turns OFF when the valve position is fully closed (FBR input value ≤ 0 %). *

The open-side output turns OFF when the valve position is fully opened (FBR input value ≥ 100 %). *

[When the Action at saturated output is valid]

The close-side output remains ON when the valve position is fully closed (FBR input value ≤ 0 %). *

The open-side output remains ON when the valve position is fully opened (FBR input value ≥ 100 %). *

* When controlling the valve position by Output limiter, the output limiter value becomes the close-side (or the open-side) output value.



To validate the Action at saturated output, make sure to use valve with limit switch.



Refer to the Action at Feedback resistance (FBR) input error for the valve action when the FBR input is broken.

Function block 54 (F54.)

F54.

This is the first parameter symbol of Function block 54 (F54.).

F54.

ST start condition

SFS

Timing (starting condition) to activate the Startup tuning (ST) function is selected.

Data range	Factory set value
0: Activate the Startup tuning (ST) function when the power is turned on; when transferred from STOP to RUN; or when the Set value (SV) is changed.	0
1: Activate the Startup tuning (ST) function when the power is turned on; or when transferred from STOP to RUN.	
2: Activate the Startup tuning (ST) function when the Set value (SV) is changed.	

Related parameter

Operation mode:

- Startup tuning (ST) (P. 7-16)

F54.

ST proportional band adjusting factor

STPF

This is a factor which is multiplied by the Proportional band computed by executing the Startup tuning (ST) function.

Data range	Factory set value
0.01 to 10.00 times	1.00

Related parameter

Operation mode:

- Startup tuning (ST) (P. 7-16)

F54.

ST integral time adjusting factor

This is a factor which is multiplied by the Integral time computed by executing the Startup tuning (ST) function.

Data range	Factory set value
0.01 to 10.00 times	1.00

Related parameter

Operation mode:

- Startup tuning (ST) (P. 7-16)

F54.

ST derivative time adjusting factor

This is a factor which is multiplied by the Derivative time computed by executing the Startup tuning (ST) function.

Data range	Factory set value
0.01 to 10.00 times	1.00

Related parameter

Operation mode:

- Startup tuning (ST) (P. 7-16)

Function block 55 (F55.)



This is the first parameter symbol of Function block 55 (F55.).

F55.

Automatic temperature rise group

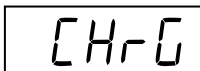

Commu-
nication
OPTION



Group No. when conducting an Automatic temperature rise.

Controllers with the same group numbers are collected in one group and the temperature is risen by other controllers so that they will synchronize with a controller whose temperature rise is slowest in that group.

Data range	Factory set value
0 to 16 (0: Automatic temperature rise function OFF)	0

-  The Automatic temperature rise function via Intercontroller communication is executed when the Communication 2 port is ready to be used and the Communication 2 protocol (CMP2) is set to “2: Intercontroller communication.”
-  If the group RUN/STOP function via Intercontroller communication is used, all of the controllers in one group can simultaneously start rising the temperature.
-  For the Automatic temperature rise, refer to **6.14.4 Automatic temperature rise function [with learning function] (P. 6-72)**.

Related parameters

Operation mode:

- Automatic temperature rise learning (P. 7-17)

Engineering mode:

- RUN/STOP group (P. 7-166)
- Automatic temperature rise dead time (P. 7-167)
- Automatic temperature rise gradient data (P. 7-167)
- Communication 2 protocol (P. 7-168)

F55.

RUN/STOP group

r50

Group No. when RUN/STOP transfer is made for each group.

Controllers with the same group numbers are collected in one group and RUN/STOP transfer is made for each group.

Data range	Factory set value
0 to 16 (0: RUN/STOP group function OFF)	0

- The group RUN/STOP function via Intercontroller communication is executed when the Communication 2 port is ready to be used and the Communication 2 protocol (CMP2) is set to “2: Intercontroller communication.”
- If even one controller in the same group is set to STOP (control stop) by Key operation, Communication or Digital input (DI), STOP (control stop) results.
- If even one controller in the same group is set to RUN (control start) by Key operation, Communication or Digital input (DI), RUN (control start) results. However, no RUN results if there is even one controller whose Digital input (DI) is set to STOP.
- If the group RUN/STOP function is used when an Automatic temperature rise via Intercontroller communication is made, all of the controllers in one group can simultaneously start rising the temperature.
- For selecting group RUN/STOP, refer to **6.14.3 Group RUN/STOP function (P. 6-63)**.

Related parameters

Operation mode:

- RUN/STOP transfer (P. 7-18)

Engineering mode:

- Automatic temperature rise group (P. 7-165)
- Communication 2 protocol (P. 7-168)

F55.

Automatic temperature rise dead time

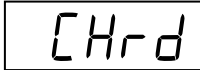

Control response dead time of a controlled object. It is computed by Automatic temperature rise learning.

Data range	Factory set value
0.1 to 1999.9 seconds	10.0

 The Automatic temperature rise dead time is also computed when the Startup tuning (ST) function [only when power is turned on] is executed.

 For the Automatic temperature rise, refer to **6.14.4 Automatic temperature rise function [with learning function]** (P. 6-72).

Related parameters

Operation mode:

- Startup tuning (ST) (P. 7-16)
- Automatic temperature rise learning (P. 7-17)

Engineering mode:

- Automatic temperature rise group (P. 7-165)
- Automatic temperature rise gradient data (P. 7-167)

F55.

Automatic temperature rise gradient data

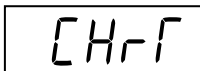

This parameter is used to set the temperature change per one minute when the Automatic temperature rise is performed.

It is computed by Automatic temperature rise learning.

Data range	Factory set value
0.1 to Input span/minutes	1.0

 The Automatic temperature rise gradient data is also computed when the Startup tuning (ST) function [only when power is turned on] is executed.

 For the Automatic temperature rise, refer to **6.14.4 Automatic temperature rise function [with learning function]** (P. 6-72).

Related parameters

Operation mode:

- Startup tuning (ST) (P. 7-16)
- Automatic temperature rise learning (P. 7-17)

Engineering mode:

- Automatic temperature rise group (P. 7-165)
- Automatic temperature rise dead time (P. 7-167)

Function block 60 (F60.)



This is the first parameter symbol of Function block 60 (F60.).

The settings of parameters in this block become valid on the controller with the Communication function (optional).

F60.

Communication 1 protocol Communication 2 protocol

Commu-
nication
OPTION

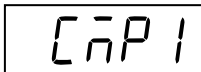

Communication 1 protocol:

Use to select the protocol for Communication 1 function.

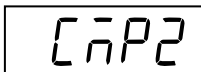

Communication 2 protocol:

Use to select the protocol for Communication 2 function.

Data range	Factory set value
Communication 1 protocol: 0: RKC communication 1: Modbus	0 If the Communication 1 protocol is specified by the model and suffix code when ordering, that Communication 1 protocol becomes the factory set value.
Communication 2 protocol: 0: RKC communication 1: Modbus 2: Intercontroller communication	2



For the Intercontroller communication, refer to **6.14 Group operation by the Intercontroller communication (P. 6-60)**.



For the Communication function, refer to the separate **FB100/FB400/FB900 Communication Instruction Manual (IMR01W04-E□)**.

Related parameters

Setup setting mode:

- Device address 1, Device address 2 (P. 7-44)
- Communication speed 1, Communication speed 2 (P. 7-44)
- Data bit configuration 1, Data bit configuration 2 (P. 7-45)
- Interval time 1, Interval time 2 (P. 7-46)

Engineering mode:

- External input type (P. 7-125)
- Automatic temperature rise group (P. 7-165)
- RUN/STOP group (P. 7-166)

Function block 70 (F70.)



This is the first parameter symbol of Function block 70 (F70.).

F70.

Setting change rate limiter unit time

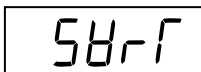

Set the time unit for Setting change rate limiter (up/down).

Data range	Factory set value
1 to 3600 seconds	60

Related parameter

Parameter setting mode:

- Setting change rate limiter (up), Setting change rate limiter (down) (P. 7-31)

F70.

Soak time unit

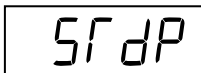

Use to select the time unit for Area soak time.

Data range	Factory set value
0: 0 hours 00 minutes to 99 hours 59 minutes	1
1: 0 minutes 00 seconds to 199 minutes 59 seconds	

Related parameter

Parameter setting mode:

- Area soak time (P. 7-32)

Function block 71 (F71.)

F71.

This is the first parameter symbol of Function block 71 (F71.).

F71.

Setting limiter high

Setting limiter low

SLH

Setting limiter high: Use to set a high limit of the set value.

Setting limiter low: Use to set a low limit of the set value.

SLL

Data range	Factory set value
Setting limiter high: Setting limiter low to Input scale high Varies with the setting of the Decimal point position (P. 7-71).	Input scale high
Setting limiter low: Input scale low to Setting limiter high Varies with the setting of the Decimal point position (P. 7-71).	Input scale low

Related parameters

Engineering mode:

- Decimal point position (P. 7-71)
- Input scale high, Input scale low (P. 7-72)

■ Description of function

Setting limiter is to set the range of the Set value (SV).

[Example] The input range (input scale range) is from 0 to 400 °C, the Setting limiter high is 200 °C, and the Setting limiter low is 20 °C.

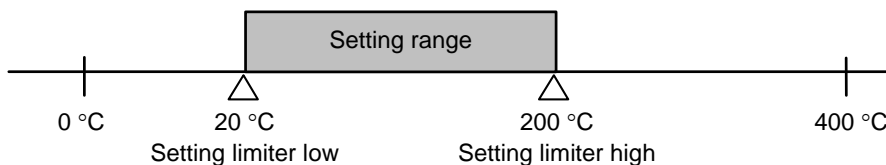

Function block 91 (F91.)

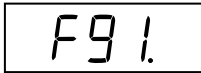

This is the first parameter symbol of Function block 91 (F91.).

F91.

ROM version monitor

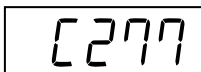

Displays the version of loaded software.

Display range	Factory set value
Version of ROM built in the controller	—

F91.

Integrated operating time monitor

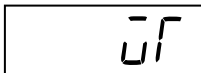

Displays the integrated total operating time of the controller.

Display range	Factory set value
0 to 19999 hours	—

F91.

Holding peak value ambient temperature monitor

Displays the maximum ambient temperature of the instrument.

Display range	Factory set value
-10.0 to +100.0 °C	—

F91.

Power feed forward input value monitor

Displays the input value of a power feed transformer.

Display range	Factory set value
0.0 to 160.0 % Display in the percentage of the load voltage (rated value).	—

Related parameters

Engineering mode:

- Power feed forward selection (P. 7-140)
- Power feed forward gain (P. 7-141)



Display returns to the PV/SV monitor screen if no key operation is performed within 1 minute (except during the Power feed forward input value monitor display).

TROUBLE SHOOTING

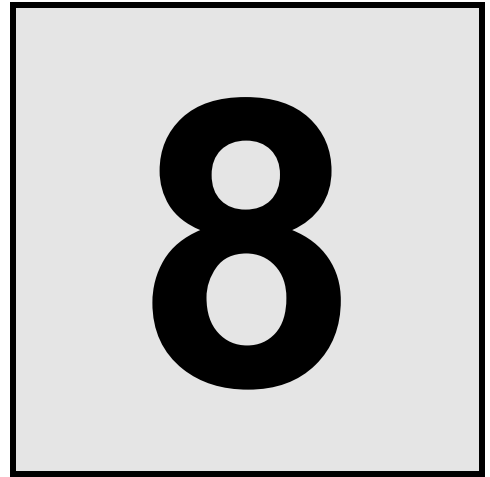

8.1 Error Display	8-2
8.2 Solutions for Problems.....	8-4

8.1 Error Display

This Section describes error display when the Measured value (PV) exceeds the display range and the self-diagnostic error.

■ Display when input error occurs

The table below shows displays, description, control actions and solutions when the Measured value (PV) exceeds the display range.

 **Prior to replacing the sensor, always turn OFF the power or change to STOP with RUN/STOP transfer.**

Display	Description	Action (Output)	Solution
Measured value (PV) [Flashing]	<ul style="list-style-type: none"> Measured value (PV) exceeds the Input scale high/low. Measured value (PV) exceeds the Input error determination point (high/low limit). 	<ul style="list-style-type: none"> Action at input error: Output depending on the action at Input error (high/low limit) [Refer to page 7-135.] 	Check input type, input range, sensor and sensor connection.
0000 [Flashing]	Over-scale Measured value (PV) is above the display range limit high (or +19999).	<ul style="list-style-type: none"> Event output: Output depending on the event action at input error 	
LLLLL [Flashing]	Underscale Measured value (PV) is below the display range limit low (or -19999).		

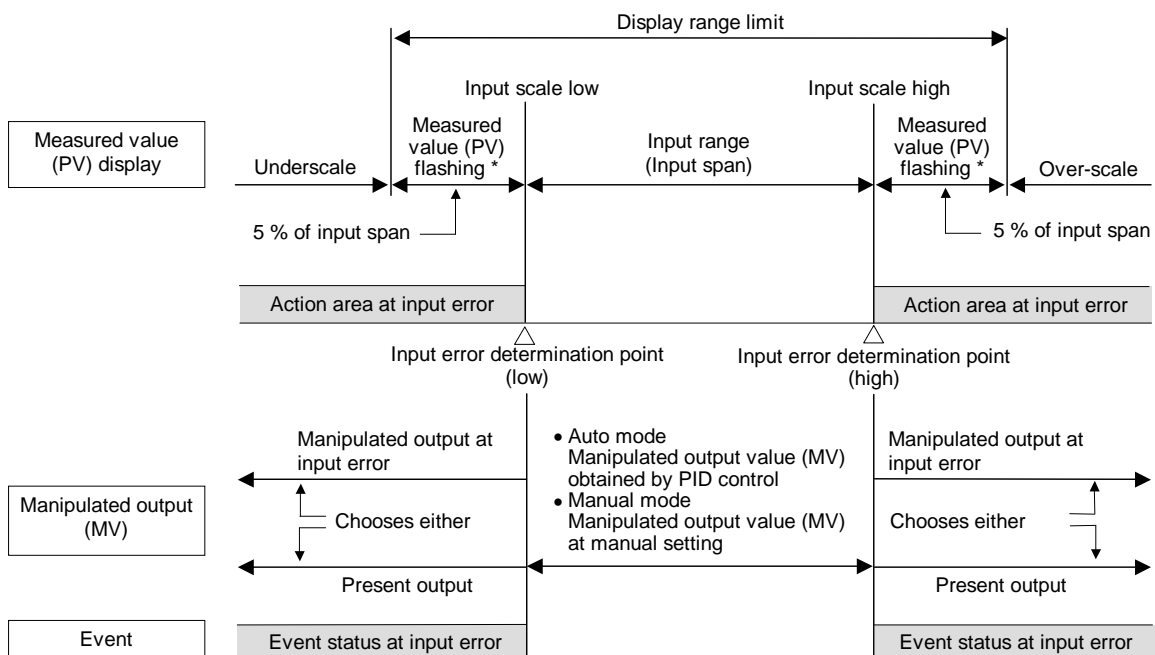

■ Self-diagnostic error

In an error is detected by the Self-diagnostic function, the PV display shows “Err,” and the SV display shows the error code. If two or more errors occur simultaneously, the total summation of these error code is displayed.

Error number	Description	Action	Solution
1	Adjusted data error • Adjusted data range is abnormal.	Display: Error display (Err)	Turn off the power at once. If the FB400/900 is restored to normal after the power is turned on again, then probable cause may be external noise source affecting the control system. Check for the external noise source. If an error occurs after the power is turned on again, the FB400/900 must be repaired or replaced. Please contact RKC sales office or the agent.
2	Back-up error • Back-up action is abnormal. • Data write failure	Output: All the output is OFF (Same as the power off)	
4	A/D conversion error • Response signal from A/D converter is abnormal.	Communication: Possible	
32	Custom data error • There is an abnormality on download data and it cannot execute.	<p><Example of error display></p>	
128	Watchdog timer error • The part of an internal program stops the action.		
256	Stack overflow • Stack area of stack pointer overflows		
2048	Program error (busy) • Could not finish an internal program in a specified time.		

If any of the following error occurs, all action of the FB400/900 is stopped. In this case, the error number is not displayed.

Description	Action	Solution
Power supply voltage is abnormal (power supply voltage monitoring)	Display: All display is OFF Output: All output is OFF	The FB400/900 must be repaired or replaced.
RAM error (RAM check)	Communication: No response	Please contact RKC sales office or the agent.

8.2 Solutions for Problems

This section explains possible causes and solutions if any abnormality occurs in the instrument. For any inquiries or to confirm the specifications of the product, please contact RKC sales office or the agent.

If it is necessary to replace a device, always strictly observe the warnings below.



WARNING

- To prevent electric shock or instrument failure, always turn off the system power before replacing the instrument.
- To prevent electric shock or instrument failure, always turn off the power before mounting or removing the instrument.
- To prevent electric shock or instrument failure, do not turn on the power until all wiring is completed. Make sure that the wiring is correct before applying power to the instrument.
- To prevent electric shock or instrument failure, do not touch the inside of the instrument.
- All wiring must be performed by authorized personnel with electrical experience in this type of work.

CAUTION

All wiring must be completed before power is turned on to prevent electric shock, instrument failure, or incorrect action. The power must be turned off before repairing work for input break and output failure including replacement of sensor, contactor or SSR, and all wiring must be completed before power is turned on again.

■ Display

Problem	Possible cause	Solution
No display appears	The internal assembly is not inserted into the case correctly.	Insert the internal assembly into the case correctly.
	Power supply terminal connection not correct.	Connect the terminals correctly by referring to 4.3 Wiring of Each Terminal (P. 4-6) .
	Power supply terminal contact defect.	Retighten the terminals
	The proper power supply voltage is not being supplied.	Apply the normal power supply by referring to 9. SPECIFICATIONS (P. 9-1) .
Display is abnormal	Noise source is present near the instrument.	Separate the noise source from the instrument. Set the appropriate digital filter according to the responding control systems.
	The terminal board on the instrument using the thermocouple is directly exposed to the air from an air conditioner.	Do not directly expose the terminal board to the air from the air conditioner.
	Remote setting signal input is in parallel to two or more this instruments which use grounding type thermocouples.	Insert an isolator to enable isolated remote setting signal input for each instrument.
	Measured value (PV) display differs from the actual value	Proper sensor is not used. The PV bias is set. The PV ratio is set.
Display value fluctuates	Setting of measured input sampling cycle is not appropriate. (Factory set value: 100 ms)	Set the appropriate sampling cycle by referring to Sampling cycle (P. 7-76) . However, this is limited only to when the sampling cycle setting can be changed.



How to check if the input function of the controller is working correctly.

- When the controller is configured as Thermocouple input:
Short the input terminals No. 23 and No. 24. If the controller shows a Measured value around the ambient temperature of the input terminals, the input function of the controller is working correctly.
- When the controller is configured as RTD input:
Connect a 100 Ω resistor between the input terminals No. 22 and No. 23 and short the input terminals No. 23 and No. 24. If the controller shows Measured value around 0 °C (32 °F), the input function of the controller is working correctly.
- When the controller is configured as Voltage/Current input:
Input a certain voltage or current from a voltage/current generator to the controller. If the controller shows the equivalent input value, the input setting and function of the controller is working correctly.

■ Control

Problem	Possible cause	Solution
Control is abnormal	The proper power supply voltage is not being supplied.	Apply the normal power supply by referring to 9. SPECIFICATIONS (P. 9-1) .
	Break of sensor and input lead wires	Turn off the power or STOP the operation by “RUN/STOP transfer” and repair the sensor or replace it.
	Sensor wiring improperly conducted	Conduct sensor wiring correctly by referring to 4.3 Wiring of Each Terminal (P. 4-6) .
	Proper sensor is not used.	Use the specified sensor.
	Sensor insertion depth is insufficient.	Check whether sensor is inserted loosely. If yes, fully insert the sensor.
	Sensor insertion position is not appropriate.	Insert the sensor at the specified location.
	Input signal wires are not separated from instrument power and/or load wires.	Separate each wire.
	Noise source is present near the wiring.	Separate the noise source from the wiring.
	Inappropriate PID constants	Set the appropriate PID constants.
Startup tuning (ST) function cannot be activated	Startup tuning (ST) mode is “oFF.” (Factory set value: oFF)	Refer to 6.6 Startup Tuning (ST) (P. 6-18) .
	Requirements for performing the Startup tuning (ST) function are not satisfied.	Satisfy the requirements for performing the Startup tuning (ST) function by referring to 6.6 Startup Tuning (ST) (P. 6-18) .
Autotuning (AT) function not activated	Requirements for performing the Autotuning (AT) function are not satisfied.	Satisfy the requirements for performing the Autotuning (AT) function by referring to 6.5 Autotuning (AT) (P. 6-15) .
Autotuning (AT) suspended	Requirements for suspending the Autotuning (AT) function are established.	Identify causes for Autotuning (AT) suspension by referring to 6.5 Autotuning (AT) (P. 6-15) and then remove them. Then, execute the Autotuning (AT) function again.

Continued on the next page.

Continued from the previous page.

Problem	Possible cause	Solution
Acceptable PID values can not be computed by Autotuning (AT)	The Autotuning (AT) function does not appropriately match the characteristics of the controlled object.	Set PID constants manually.
	The output change rate limiter is set.	Set PID constants manually.
		Set the Output change rate limiter to "0.0: OFF" by referring to Output change rate limiter (up/down) (P. 7-137) . However, this is limited only to when the Output change rate limiter setting can be changed.
Autotuning (AT) cannot be finished normally	A temperature change (UP and/or Down) is 1 °C or less per minute during Autotuning.	Set PID constants manually.
	Autotuning (AT) is activated when the set value is around the ambient temperature or is close to the maximum temperature achieved by the load.	
No output change in step	The output change rate limiter is set.	Set the Output change rate limiter to "0.0: OFF" by referring to Output change rate limiter (up/down) (P. 7-137) . However, this is limited only to when the Output change rate limiter setting can be changed.
Output does not become more than (or less than) a specific value	The output limiter is set.	Change the Output limiter setting by referring to Output limiter (high/low) (P. 7-138) . However, this is limited only to when the Output limiter setting can be changed.

■ Operation

Problem	Possible cause	Solution
No control RUN can be made by key operation (Digital input: Only DI5)	RUN/STOP transfer of the Digital input (DI) is set to the contact opened.	Check the contact state of RUN/STOP transfer by referring to 6.4 RUN/STOP Transfer (P. 6-11) .
No Manual mode can be made by key operation. (Digital input: any of DI5 to DI7)	Auto/Manual transfer of the Digital input (DI) is set to the contact opened.	Check the contact state of Auto/Manual transfer by referring to 6.7 Auto/Manual Transfer (P. 6-23) .
No Remote mode can be made by key operation (Digital input: either DI5 or DI6)	Remote/Local transfer of the Digital input (DI) is set to the contact opened.	Check the contact state of Remote/Local transfer by referring to 6.8 Remote/Local Transfer (P. 6-28) .
No control area transfer can be made by key operation Digital input (DI1 to DI3): Area transfer Digital input (DI4): Area set	Control area transfer of the Digital input (DI) is set to the contact opened.	Check the contact state of control area transfer by referring to 6.9 Control Area Transfer (P. 6-32) .
No setting change can be made by key operation	Set data is locked.	Release the Set data lock by referring to Set lock level (P. 7-47) .
Set value (SV) does not become more than (or less than) a specific value	The Setting limiter is set	Change the Setting limiter setting by referring to Setting limiter high/low (P. 7-170) . However, this is limited only to when the Setting limiter setting can be changed.
Set value (SV) does not change immediately when the set value (SV) is changed	The Setting change rate limiter is set.	Set the Setting change rate limiter to "OFF" by referring to Setting change rate limiter (up/down) (P. 7-31) . However, this is limited only to when the Setting limiter setting can be changed.
Remote setting (RS) input value display differs from the actual value	The RS bias is set.	Set the RS bias to "OFF" by referring to RS bias (P. 7-42) . However, this is limited only to when the RS bias setting can be changed.
	The RS ratio is set.	Change the RS ratio setting by referring to RS ratio (P. 7-42) . However, this is limited only to when the RS ratio setting can be changed.

■ Event function

Problem	Possible cause	Solution
Event function is abnormal	Event function is different from the specification.	Change the Event action type by referring to Event 1 type (P. 7-85) , Event 2 type (P. 7-95) , Event 3 type (P. 7-102) , or Event 4 type (P. 7-109) after the instrument specification is confirmed.
	Digital output (DO) relay contact Energized/De-energized is reversed. When FAIL is selected for digital output: De-energized fixed: Contact opens under FAIL	Check the setting details by referring to Energized/De-energized (P. 7-80) .
	Setting of Event differential gap is not appropriate.	Set the appropriate Event differential gap by referring to Event differential gap (P. 7-90, P. 7-99, P. 7-106, P. 7-113) .
No output of the Event function is turned on	Event function is not assigned to the Digital output (DO).	Check the contents of Output assignment by referring to Output assignment (P. 7-79) .
Event hold action is not activated.	The Setting change rate limiter is set.	Set the Setting change rate limiter to "OFF" by referring to Setting change rate limiter (up/down) (P. 7-31) . However, this is limited only to when the Setting limiter setting can be changed.

■ Heater break alarm (HBA)

Problem	Possible cause	Solution
No Heater break can be detected	Setting of Heater break alarm is not appropriate.	Set the appropriate Heater break alarm value.
	The CT is not connected.	Connect the CT by referring to 4.3 Wiring of Each Terminal (P. 4-6) .
CT input value is abnormal	Proper CT is not used.	Use the specified CT.
	The heater is broken.	Check the heater.
	CT wiring improperly conducted	Conduct CT wiring correctly by referring to 4.3 Wiring of Each Terminal (P. 4-6) .
	Input terminal contact defect	Retighten the terminals

SPECIFICATIONS

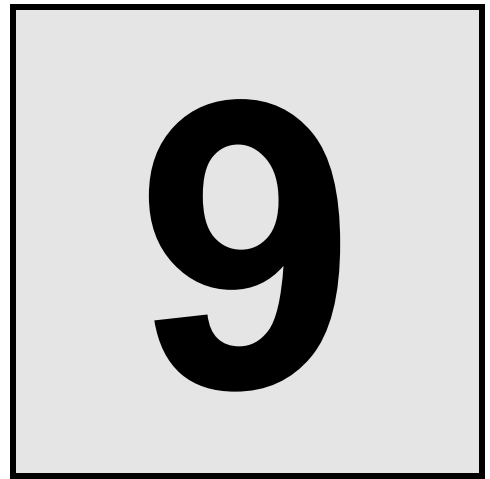

■ Measured input

Number of input: 1 point

Input type: **Temperature, Current and Voltage (low) group ***

Thermocouple (TC):

K, J, T, S, R, E, B, N (JIS-C1602-1995)

PL II (NBS), W5Re/W26Re (ASTM-E988-96)

U, L (DIN43710-1985)

RTD: Pt100 (JIS-C1604-1997)

JPt100 (JIS-C1604-1997, JIS-C1604-1981 of Pt100)

3-wire system

Voltage: 0 to 10 mV DC, -10 to +10 mV DC, 0 to 100 mV DC,
-100 to +100 mV DC, 0 to 1 V DC

Current: 4 to 20 mA DC, 0 to 20 mA DC

Voltage (high) group *

Voltage: -1 to +1 V DC, 0 to 5 V DC, 1 to 5 V DC, 0 to 10 V DC

* Universal input (Use the input select switch to change input group.)

Input range:

TC input

Input type	Measured range
K	-200.0 to +400.0 °C, -200.0 to +800.0 °C, -200 to +1372 °C, -328.0 to +400.0 °F, -250.0 to +800.0 °F, -328 to +2502 °F
J	0.0 to 400.0 °C, -200.0 to +400.0 °C, -200.0 to +800.0 °C, -200 to +1200 °C, -200.0 to +700.0 °F, -328.0 to +1200.0 °F, -328 to +2192 °F
T	-200.0 to +400.0 °C, -328.0 to +752.0 °F
S, R	-50 to +1768 °C, -58 to +3214 °F
E	-200.0 to +700.0 °C, -200 to +1000 °C, -328.0 to +1292.0 °F, -328 to +1832 °F
B	0 to 1800 °C, 0 to 3272 °F
N	0 to 1300 °C, 0 to 2372 °F
PLII	0 to 1390 °C, 0 to 2534 °F
W5Re/W26Re	0 to 2300 °C, 0 to 4200 °F
U	0.0 to 600.0 °C, 32.0 to 1112.0 °F
L	0.0 to 900.0 °C, 32.0 to 1652.0 °F

RTD input

Input type	Measured range
Pt100	-100.00 to +100.00 °C, -200.0 to +850.0 °C, -199.99 to +199.99 °F, -328.0 to +1562.0 °F
JPt100	-100.00 to +100.00 °C, -200.0 to +640.0 °C, -199.99 to +199.99 °F, -328.0 to +1184.0 °F

Voltage/Current input

Input type		Measured range
Voltage (low)	0 to 10 mV DC, -10 to +10 mV DC, 0 to 100 mV DC, -100 to +100 mV DC 0 to 1 V DC	Programmable range (-19999 to +19999)
Voltage (high)	-1 to +1 V DC, 0 to 5 V DC, 1 to 5 V DC, 0 to 10 V DC	
Current	0 to 20 mA DC, 4 to 20 mA DC	

Sampling cycle: 100 ms±0.3 % (50 ms±5 % or 250 ms±0.3 % is selectable)

Influence of external resistance:Approx. 0.2 $\mu\text{V}/\Omega$ (Converted depending on TC types)**Influence of input lead:** Approx. 0.01 %/ Ω of PV (RTD input)10 Ω or less per wire**Input impedance:**TC input: 1 M Ω or moreVoltage (low) input: 1 M Ω or moreVoltage (high) input: Approx. 1 M Ω Current input: Approx. 50 Ω **Sensor current:**Approx. 250 μA (RTD input)**Action at input beak:**

TC input: Upscale or Downscale

RTD input: Upscale

Voltage (low) input: Upscale or Downscale

Voltage (high) input: Downscale (Indicates value near 0 V)

Current input: Downscale (Indicates value near 0 mA)

Action at input short circuit:

Downscale (RTD input)

Action at input error:

Setting range of Input error determination point (high/low):

Input scale low – (5 % of input span) to Input scale high + (5 % of input span)

High/Low individual setting

Manipulated output value at input error:

–105.0 to +105.0 %

Input correction:

PV bias: –Input span to +Input span

PV ratio: 0.500 to 1.500

First order lag digital filter:

0.0 to 100.0 seconds (0.0: OFF)

Square root extraction function (Voltage input, Current input):Calculation method: Measured value = $\sqrt{\text{Input value} \times \text{PV ratio} + \text{PV bias}}$

PV low input cut-off: 0.00 to 25.00 % of input span

■ Remote setting (RS) input [provided as standard]**Number of input:**

1 point (Not isolated from measured input)

Input type:

Voltage (low) input: 0 to 10 mV DC, 0 to 100 mV DC, 0 to 1 V DC

Voltage (high) input: 0 to 5 V DC, 1 to 5 V DC, 0 to 10 V DC

Current input: 0 to 20 mA DC, 4 to 20 mA DC

Sampling cycle:

200 ms (twice of the measured input sampling cycle)

100 ms (twice of the measured input sampling cycle)

500 ms (twice of the measured input sampling cycle)

Input impedance:Voltage (low) input: 1 M Ω or moreVoltage (high) input: Approx. 1 M Ω Current input: Approx. 50 Ω **Action at input beak:**

Voltage input: Downscale (Indicates value near 0 V)

Current input: Downscale (Indicates value near 0 mA)

Input correction:

RS bias: –Input span to +Input span

RS ratio: 0.001 to 9.999

RS digital filter (first order lag):

0.0 to 100.0 seconds (0.0: OFF)

Allowable input voltage:Voltage (low) input: Within ± 3.5 VVoltage (high) input: Within ± 12 V

■ Current transformer (CT) input [optional]

Number of inputs:	2 points (when PFF input is selected: 1 point)
CT type:	CTL-6-P-N or CTL-12-S56-10-N (Sold separately)
Input range:	CTL-6-P-N: 0.0 to 30.0 A CTL-12-S56-10L-N: 0.0 to 100.0 A
Sampling cycle:	200 ms (twice of the measured input sampling cycle) 100 ms (twice of the measured input sampling cycle) 500 ms (twice of the measured input sampling cycle)
CT ratio:	0 to 9999 CTL-6-P-N: 800 CTL-12-S56-10L-N: 1000
Automatic power frequency detection:	Power frequency can be set by automatic detection. However, no frequency may be able to be detected if at a CT value of less than 0.5 A.

■ Feedback resistance (FBR) input [optional]

Number of input:	1 point
Permissible resistance range:	100 Ω to 10 k Ω (Standard: 135 Ω)
Input range:	0.0 to 100.0 % (for adjustment span of open and close)
Sampling cycle:	200 ms (twice of the measured input sampling cycle) 100 ms (twice of the measured input sampling cycle) 500 ms (twice of the measured input sampling cycle)
Action at FBR break:	Upscale

■ Power feed forward (PFF) input [optional]

Number of input:	1 point (Use the special transformer)
Allowable voltage range:	Input of instrument: 0 to 20 V Load power supply voltage: 120 V AC transformer (PFT-01): 0 to 168 V AC 240 V AC transformer (PFT-02): 0 to 336 V AC
Sampling cycle:	200 ms (twice of the measured input sampling cycle) 100 ms (twice of the measured input sampling cycle) 500 ms (twice of the measured input sampling cycle)
Automatic power frequency detection:	Power frequency can be set by automatic detection.

■ Digital input (DI)

Number of inputs:	7 points (4 points: DI1 to DI4 [optional], 3 points: DI5 to DI7)
Input method:	Dry contact input Open state: 500 k Ω or more Close state: 10 Ω or less Contact current: 5 mA or less Voltage at open: Approx. 5 V DC
Capture judgment time:	200 ms

■ Output (OUT1, OUT2)

Number of outputs:	Up to 2 points (Output 1, Output 2)
Output contents:	Used for control output or digital output (DO) (Specify when ordering)
Output type:	<p>Relay contact output</p> <p>Contact type: 1a contact</p> <p>Contact rating (Resistive load): 250 V AC 3 A, 30 V DC 1 A</p> <p>Electrical life: 300,000 times or more (Rated load)</p> <p>Mechanical life: 50 million times or more (Switching: 180 times/min)</p> <p>Voltage pulse output</p> <p>Output voltage: 0/12 V DC (Rating) ON voltage: 11 V or more, 13 V or less OFF voltage: 0.2 V or less</p> <p>Allowable load resistance: 600 Ω or more</p> <p>Current output</p> <p>Output current (Rating): 4 to 20 mA DC, 0 to 20 mA DC</p> <p>Output range: 1 to 21 mA DC, 0 to 21 mA DC</p> <p>Allowable load resistance: 600 Ω or less</p> <p>Output impedance: 1 MΩ or more</p> <p>Voltage output</p> <p>Output voltage (Rating): 0 to 10 V DC, 0 to 5 V DC, 1 to 5 V DC</p> <p>Output range: -0.5 to +10.5 V DC, -0.25 to +5.25 V DC, 0.8 to 5.2 V DC</p> <p>Allowable load resistance: 1 kΩ or more</p> <p>Output impedance: 0.1 Ω or less</p> <p>Triac output</p> <p>Output method: AC output (Zero-cross method)</p> <p>Allowable load current: 0.5 A (Ambient temperature 40 °C or less) Ambient temperature 50 °C: 0.3 A</p> <p>Load voltage: 75 to 250 V AC</p> <p>Minimum load current: 30 mA</p> <p>ON voltage: 1.6 V or less (at maximum load current)</p> <p>Open collector output</p> <p>Output method: Sink type</p> <p>Allowable load current: 100 mA</p> <p>Load voltage: 30 V DC or less</p> <p>Minimum load current: 0.5 mA</p> <p>ON voltage: 2 V or less (at maximum load current)</p> <p>Leakage current at OFF: 0.1 mA or less</p>

■ Digital output (DO1 to DO4) [optional]

Number of outputs:	Up to 4 points
Output contents:	Used only for the event function (Specify when ordering)
Output type:	Relay contact output
	Contact type: 1a contact
	Contact rating (Resistive load): 250 V AC 1 A, 30 V DC 1 A
	Electrical life: 300,000 times or more (Rated load)
	Mechanical life: 20 million times or more (Switching: 300 times/min)

■ Transmission output (AO) [optional]

Number of outputs:	1 point
Output contents:	Measured value (PV), Set value (SV) monitor, Deviation value, Set value (SV), Manipulated output (MV1) [heat-side] ^{1,2} , Manipulated output (MV2) [cool-side] ³ , Remote setting (RS) input value
	¹ Heat/Cool PID control: Output value [heat-side] ² Position proportioning PID control: Feedback resistance input value ³ Output value [cool-side] in Heat/Cool PID control
Output type:	Voltage output
	Output voltage (Rating): 0 to 10 V DC, 0 to 5 V DC, 1 to 5 V DC, 0 to 1 V DC
	Output range: -0.5 to +10.5 V DC, -0.25 to +5.25 V DC, 0.8 to 5.2 V DC, -0.05 to +1.05 V DC
	Allowable load resistance: 1 k Ω or more
	Output impedance: 0.1 Ω or less
	Current output
	Output current (Rating): 4 to 20 mA DC, 0 to 20 mA DC
	Output range: 1 to 21 mA DC, 0 to 21 mA DC
	Allowable load resistance: 600 Ω or less
	Output impedance: 1 M Ω or more
Output scaling:	High/Low individual setting
	Measured value (PV): Input scale low to Input scale high
	Deviation value: -Input span to +Input span
	Set value (SV) monitor: Input scale low to Input scale high
	Remote setting (RS) input value: Input scale low to Input scale high
	Manipulated output value (MV1) [heat-side]: -5.0 to +105.0 %
	Manipulated output value (MV2) [cool-side]: -5.0 to +105.0 %

■ **Performance (at the ambient temperature 23 ± 2 °C):**

Input accuracy:

Measured input:

[For Fahrenheit: Converted value of Celsius]

Input type	Input range	Accuracy
K, J, T, PLH, E, U, L	Less than -100 °C	± 1.0 °C
	-100 °C or more, less than $+500$ °C	± 0.5 °C
	500 °C or more	$\pm(0.1\% \text{ of Reading} + 1 \text{ digit})$
S, R, N, W5Re/W26Re	Less than 0 °C	± 2.0 °C
	0 °C or more, less than 1000 °C	± 1.0 °C
	1000 °C or more	$\pm(0.1\% \text{ of Reading} + 1 \text{ digit})$
B	Less than 400 °C	± 70.0 °C
	400 °C or more, less than 1000 °C	$\pm(1.4 \text{ °C} + 1 \text{ digit})$
	1000 °C or more	$\pm(0.1\% \text{ of Reading} + 1 \text{ digit})$
Pt100, JPt100	Less than 200 °C	± 0.2 °C
	200 °C or more	$\pm(0.1\% \text{ of Reading} + 1 \text{ digit})$
Voltage input	$\pm 0.1\%$ of input span	
Current input		

Remote setting (RS) input:

Voltage input: $\pm 0.1\%$ of input span

Current input: $\pm 0.1\%$ of input span

Current transformer (CT) input:

$\pm 5\%$ of Reading ± 1 digit or ± 2 A (whichever is larger)

Feedback resistance (FBR) input:

$\pm 0.5\%$ ± 1 digit of input span (for adjustment span of open and close)

Output accuracy:

Current output: $\pm 3\%$ of span (Output 1, Output 2)

$\pm 0.1\%$ of span (Transmission output)

Voltage output: $\pm 3\%$ of span (Output 1, Output 2)

$\pm 0.1\%$ of span (Transmission output)

Cold-junction temperature compensation error:

Within ± 1.0 °C

Within ± 1.5 °C (Between -10 to $+50$ °C)

Close horizontal mounting error:

Within ± 1.5 °C

Influence of physical orientation ($\pm 90^\circ$):

Input: TC input: $\pm 0.3\%$ of input span or ± 3.0 °C or less

RTD input: ± 0.5 °C or less

Voltage/Current input:

Less than $\pm 0.1\%$ of input span

Output: Less than $\pm 0.3\%$ of output span

■ Control

- Control method:**
- a) Brilliant II PID control (Direct/Reverse action is selectable)
 - b) Brilliant II Heat/Cool PID control
 - c) Brilliant II Position proportioning PID control without FBR (Direct/Reverse action is selectable)
- a), b), c) is selectable
- Autotuning:**
- For PID control (Direct/Reverse action)
 - For Heat/Cool PID control (for Extruder [air cooling])
 - For Heat/Cool PID control (for Extruder [water cooling])
 - For Heat/Cool PID control
- Startup tuning (ST):** When in Heat/Cool PID control, it is possible to execute the Startup tuning (ST) function only in the temperature rise direction.
The PID values on the heat side are automatically computed.
Becomes invalid when in Position proportioning PID control.

■ Brilliant II PID control

- Setting range:**
- a) Proportional band (P) *
 - Temperature input: 0 to Input span (unit: °C [°F])
 - Voltage/Current input: 0.0 to 1000.0 % of input span
 - * 0 [0.0]: ON/OFF action
 - ON/OFF action differential gap:
 - Temperature input: 0.0 to Input span (unit: °C [°F])
 - Voltage/Current input: 0.0 to 10.0 % of input span
 - b) Integral time (I): 0 to 3600 seconds or 0.0 to 1999.9 seconds
(0 [0.0]: Integral action OFF)
 - c) Derivative time (D): 0 to 3600 seconds or 0.0 to 1999.9 seconds
(0 [0.0]: Derivative action OFF)
 - d) Control response parameter:
Slow, Medium and Fast (3-step selection)
 - e) Proportional cycle time: 0.1 to 100.0 seconds
 - f) Output limiter high/low:
 - 5.0 to +105.0 %
 - Output limiter low ≤ Output limiter high
 - High/Low individual setting
 - g) Output change rate limiter (up/down):
 - 0.0 to 100.0 %/seconds of manipulated output
 - (0.0: Output change rate limiter OFF)
 - Up/Down individual setting
 - h) Manual reset: -100.0 to +100.0 %
 - i) Manual output: Output limiter low to Output limiter high
 - j) Manipulated output value at (MV) at STOP mode:
 - 5.0 to +105.0 %

■ Brilliant II Heat/Cool PID control

Setting range:

- a) Proportional band (P) *
- Temperature input: 0 to Input span (unit: °C [°F])
 - Voltage/Current input: 0.0 to 1000.0 % of input span
- * 0 [0.0]: ON/OFF action
ON/OFF action differential gap:
Temperature input: 0.0 to Input span (unit: °C [°F])
Voltage/Current input: 0.0 to 10.0 % of input span
- b) Integral time (I): 0 to 3600 seconds or 0.0 to 1999.9 seconds
(0 [0.0]: Integral action OFF)
- c) Derivative time (D): 0 to 3600 seconds or 0.0 to 1999.9 seconds
(0 [0.0]: Derivative action OFF)
- d) Proportional band [cool-side]:
- Temperature input: 1 (0.1 or 0.01) to Input span (unit: °C [°F])
 - Voltage/Current input: 0.1 to 1000.0 % of input span
- e) Integral time [cool-side]:
0 to 3600 seconds or 0.0 to 1999.9 seconds
(0 [0.0]: Integral action OFF)
- f) Derivative time [cool-side]:
0 to 3600 seconds or 0.0 to 1999.9 seconds
(0 [0.0]: Derivative action OFF)
- g) Overlap/Deadband:
- Temperature input: –Input span to +Input span (unit: °C [°F])
 - Voltage/Current input: –100.0 to +100.0 % of input span
- Minus (–) setting results in overlap.
(However, the overlapping range is within the proportional range.)
- h) Control response parameter:
Slow, Medium and Fast (3-step selection)
- i) Proportional cycle time: 0.1 to 100.0 seconds
- j) Proportional cycle time [cool-side]:
0.1 to 100.0 seconds
- k) Output limiter high/low:
–5.0 to +105.0 %
Output limiter low ≤ Output limiter high
High/Low individual setting
- l) Output change rate limiter (up/down):
0.0 to 100.0 %/seconds of manipulated output
(0.0: Output change rate limiter OFF)
Up/Down individual setting
- m) Manual reset: –100.0 to +100.0 %
- n) Manual output: –Output limiter high [cool-side] to
Output limiter high [heat-side]
For overlap: –105.0 to +105.0 % *
* Actual output value is limited by the output limiter function.
- o) Manipulated output value at (MV) at STOP mode:
–5.0 to +105.0 %
Heat-side/Cool-side individual setting
- p) Overlap/Deadband reference point:
0.0 to 1.0 (0.0: Proportional band on heat-side)

■ Brilliant II Position proportioning PID control without FBR

Setting range:

- a) Proportional band (P) *
- Temperature input: 0 to Input span (unit: °C [°F])
 - Voltage/Current input: 0.0 to 1000.0 % of input span
- * 0 [0.0]: ON/OFF action
ON/OFF action differential gap:
- Temperature input: 0.0 to Input span (unit: °C [°F])
 - Voltage/Current input: 0.0 to 10.0 % of input span
- b) Integral time (I): 1 to 3600 seconds or 0.1 to 1999.9 seconds
- c) Derivative time (D): 0 to 3600 seconds or 0.0 to 1999.9 seconds
- d) Control response parameter:
Slow, Medium, Fast (3-step selection)
- e) Control motor time: 5 to 1000 seconds
- f) Output limiter high/low:
-5.0 to +105.0 %
Output limiter low ≤ Output limiter high
Invalid when feedback resistance (FBR) input is broken.
- g) Integrated output limiter:
0.0 to 200.0 % of control motor time
Invalid when feedback resistance (FBR) input is used.
- h) Open/Close output neutral zone:
0.1 to 10.0 %
- i) Open/Close output differential gap:
0.1 to 5.0 %
- j) Manipulated output value (MV) at STOP mode:
-5.0 to +105.0 %
When feedback resistance (FBR) input is provided, and it is not input break.
- k) Valve action at STOP:
- ① Close-side output OFF, Open-side output OFF
 - ② Close-side output ON, Open-side output OFF
 - ③ Close-side output OFF, Open-side output ON
- Selectable when Feedback resistance (FBR) input is not specified or when it is specified but broken.
- l) Manual output:
When there is a feedback resistance (FBR) input:
Output limiter low to Output limiter high
When there is no feedback resistance (FBR) input:
It is possible to set the output ON/OFF by pressing the UP or DOWN key.

m) Action at saturated output:

0 (Invalid), 1 (Valid)

When the Action at saturated output is valid:

- The close-side output remains ON when the valve position is fully closed
- The open-side output remains ON when the valve position is fully opened

To validate the Action at saturated output, make sure to use valve with limit switch.

■ Event function [optional]

Number of events:	Up to 4 points (Event function 1 to 4)
Event action:	Deviation high, Deviation low, Deviation high/low, Band, Process high, Process low, SV high, SV low, MV1 high [heat-side]*, MV1 low [heat-side]*, MV2 high [cool-side], MV2 low [cool-side] * Position proportioning PID control: Feedback resistance (FBR) input value
Setting range:	<p>Deviation:</p> <ul style="list-style-type: none"> • Event setting: –Input span to +Input span • Differential gap: 0 to Input span <p>Process:</p> <ul style="list-style-type: none"> • Event setting: Same as input range • Differential gap: 0 to Input span <p>SV:</p> <ul style="list-style-type: none"> • Event setting: Same as input range • Differential gap: 0 to Input span <p>MV:</p> <ul style="list-style-type: none"> • Event setting: –5.0 to +105.0 % • Differential gap: 0.0 to 110.0 %
Output method:	Assignable to digital output (DO1 to DO4)
Additional function:	<p>Hold action: Hold action is selectable from Hold action OFF, Hold action ON, and Re-hold action ON. Valid only when the event action (Process, Deviation, or MV) is selected.</p> <p>Delay timer: 0.0 to 600.0 seconds</p> <p>Event action at input error: Event action type is selectable</p> <p>Interlock: Use/Unuse is selectable</p>

■ Control loop break alarm (LBA) [optional]

Selection method: LBA is assignable to Event function 4.
(Heat/Cool PID control: LBA is not selectable)

Setting range: LBA time: 0 to 7200 seconds (0: LBA function OFF)
LBA deadband (LBD):
0 to Input span

■ Power feed forward (PFF) function [optional]

Setting range: Power feed forward selection: 0 (Unused), 1 (Used)
Power feed forward gain: 0.01 to 5.00

■ Heater break alarm (HBA) [time-proportional control output (optional)]

Number of HBA: Up to 2 points (1 point per CT input)

Setting range: 0.0 to 100.0 A (0.0: HBA function OFF)
[HBA function OFF: The current value monitoring is available]
CT assignment: 0 to 6 (0: HBA function OFF)

Output method: Assignable to Output 2 or Digital output 2 to 4 (DO2 to DO4)

Additional function: Number of HBA delay times:
0 to 255 times

■ Heater break alarm (HBA) [continuous control output (optional)]

Number of HBA: Up to 2 points (1 point per CT input)

Setting range: 0.0 to 100.0 A (0.0: HBA function OFF)
[HBA function OFF: The current value monitoring is available]
Heater break determination point:
0.0 to 100.0 % of HBA set value
(0.0: HBA function OFF)
Heater melting determination point:
0.0 to 100.0 % of HBA set value
(0.0: HBA function OFF)
CT assignment: 0 to 6 (0: HBA function OFF)

Output method: Assignable to Output 2 or Digital output 2 to 4 (DO2 to DO4)

■ Multi-memory area function [optional]

Number of areas:	8 points
Stored parameters:	Set value (SV), Event function 1 to 4, LBA time, LBA deadband, Proportional band, Integral time, Derivative time, Control response parameter, Proportional band [cool-side], Integral time [cool-side], Derivative time [cool-side], Overlap/Deadband, Manual reset, Setting change rate limiter (up), Setting change rate limiter (down), Soak time setting, Link area number
Method of area transfer:	AREA key operation (only Direct key type 1) Communication function (optional) Event input DI1 to 4 (optional) Area soak time
Memory area link function:	Link area number: 0 to 8 (0: No link) Soak time: 00 minutes 00 seconds to 199 minutes 59 seconds or 00 hours 00 minutes to 99 hours 59 minutes (Selectable) Accuracy: $\pm 0.3\%$ of set value +1 sampling time

■ Loader communication

Loader communication:	For RKC communication protocol only
Synchronous method:	Start/Stop synchronous type
Communication speed:	38400 bps
Data format:	Start bit: 1 Data bit: 8 Parity bit: Without Stop bit: 1
Protocol:	ANSI X3.28-1976 subcategories 2.5 and A4
Maximum number of connection points:	1 point (Only COM-K) Address setting: Controller address is fixed at 0.
Connection method:	COM-K special cable (W-BV-01-1500)
Interval time:	0 ms
Other:	① Power supply from COM-K is possible However, this is only for operation to change internal set values, and thus control turns OFF (outputs are off and relays are open) and Host communication stops. The PV/SV display shows “----.” ② When the instrument power is turned on after power is supplied from COM-K, the instrument starts by reset and operates normally. ③ When power is supplied from the instrument, Loader communication can be used simultaneously with Host communication.

■ Communication [optional]

● Communication 1 (for Host communication)

Interface: Based on RS-232C, RS-485, or RS-422A, EIA standard
Multi-drop connection of RS-485 and RS-422A is available.

Protocol: RKC communication (ANSI X3.28-1976 subcategories 2.5 and A4)
Modbus-RTU

● Communication 2 (for Intercontroller communication)

Interface: Based on RS-485, EIA standard

Protocol: Intercontroller communication protocol
Also communication 2 can be used as the Host communication
(Protocol type selection is selectable [Engineering mode])

■ Intercontroller communication function [optional]

● Automatic temperature rise

Setting range: Automatic temperature rise group:
0 to 16 (0: Automatic temperature rise function OFF)

Automatic temperature rise learning:
0 (Unused), 1 (Learning)

Automatic temperature rise dead time:
0.1 to 1999.9 seconds

Automatic temperature rise gradient data:
0.1 to Input span/minute

● Cascade control

Setting range: Master channel selection:
0 to 31
(Communication 2 address of Master channel)

Cascade bias: Common to RS bias setting

Cascade ratio: Common to RS ratio setting

Cascade filter: Common to RS digital filter setting (0: Filter OFF)

● Ratio setting

Setting range: Master channel selection:
0 to 31
(Communication 2 address of Master channel)

Ratio setting bias: Common to RS bias setting

Ratio setting ratio: Common to RS ratio setting

Ratio setting filter: Common to RS digital filter setting (0: Filter OFF)

● Group RUN/STOP function

Setting range: RUN/STOP group: 0 to 16 (0: Group RUN/STOP function OFF)

■ Self-diagnostic function

Control stop (Error number is displayed [Operation: Possible]):

Adjustment data error (Err 1),
 Back-up error (Err 2),
 A/D conversion error (Err 4),
 Custom data error (Err 32),
 Watchdog timer error (Err 128),
 Stack overflow (Err 256),
 Program error (busy) (Err 2048)

Action stop (Error number is not displayed [Operation: Impossible]):

Power supply voltage monitoring, RAM check error

Instrument status:

When a self-diagnostic error occurs: All output OFF

Display: In an error is detected by the Self-diagnostic function, the PV display shows "Err," and the SV display shows the error code.

Output: Same as power OFF

■ Power

Power supply voltage:

100 to 240 V AC type:
 90 to 264 V AC [Including power supply voltage variation], 50/60 Hz,
 (Rating 100 to 240 V AC)
 Frequency variation: 50 Hz±10 %, 60 Hz±10 %
 24 V AC type:
 21.6 to 26.4 V AC [Including power supply voltage variation], 50/60 Hz,
 (Rating 24 V AC)
 Frequency variation: 50 Hz±10 %, 60 Hz±10 %
 24 V DC type:
 21.6 to 26.4 V DC [Including power supply voltage variation]
 (Rating 24 V DC)

Power consumption (at maximum load):

100 to 240 V AC type:
 FB400: 7.8 VA max. (at 100 V AC), 11.9 VA max. (at 240 V AC)
 FB900: 8.7 VA max. (at 100 V AC), 13.0 VA max. (at 240 V AC)
 24 V AC type:
 FB400: 8.2 VA max. (at 24 V AC)
 FB900: 9.3 VA max. (at 24 V AC)
 24 V DC type:
 FB400: 250 mA max. (at 24 V DC)
 FB900: 300 mA max. (at 24 V DC)
 Rush current: 12 A or less

Mounting and Structure:	Mounting method:	Panel-mounted
	Front panel material:	PPE [Flame retardancy: UL94 V-1]
	Case material:	PPE [Flame retardancy: UL94 V-1]
	Filter material:	Acrylic
Weight:	FB400:	Approx. 230 g
	FB900:	Approx. 290 g

■ Standard

Safety standards:	UL:	UL61010-1
	cUL:	CAN/CSA-C22.2 No.61010-1
CE marking:	LVD:	EN61010-1 OVERVOLTAGE CATEGORYII, POLLUTION DEGREE 2, Class II (Reinforced insulation)
	EMC:	EN61326-1
C-Tick:	EN55011	
Panel sealing:	NEMA 4X (NEMA250), IP66 (IEC60529) [Front panel]	

MEMO

APPENDIX

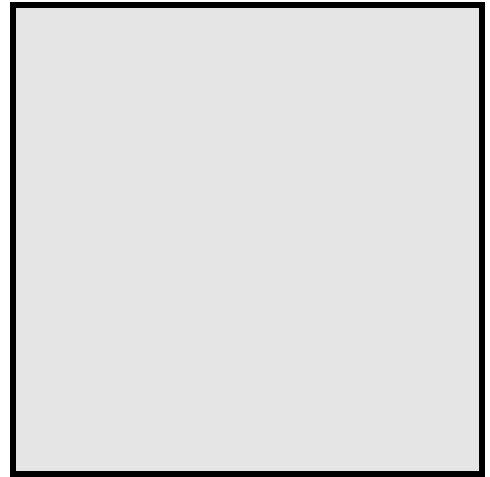

A. Removing the Internal Assembly.....	A-2
B. Replacing the Waterproof/Dustproof Rubber Packing.....	A-4
C. Transformer Dimensions for Power Feed Forward	A-6
D. Current Transformer (CT) Dimensions.....	A-7
E. Memory Area Data List.....	A-8
F. Parameter List	A-9
G. Seal [for Unit and Direct key type 2] (accessory attached)	A-25

A. Removing the Internal Assembly

Removing the internal assembly from the case is rarely required. Should you remove the internal assembly without disconnecting the external wiring, take the following steps:



WARNING

- To prevent electric shock or instrument failure, only qualified personnel should be allowed to pull out the internal assembly.
- To prevent electric shock or instrument failure, always turn off the power before pulling out the internal assembly.
- To prevent injury or instrument failure, do not touch the internal printed wiring board.



Apply pressure very carefully when removing internal assembly to avoid damage to the frame.



To conform to **IEC61010-1** requirements for protection from electric shock, the internal assembly of this instrument can only be removed with an appropriate tool.

■ Procedures

1. Insert the screwdriver in the plug-in lock section as shown in the following figure, and then lightly push the screwdriver in the horizontal direction to release the plug-in lock released bar. The plug-in lock section is released.

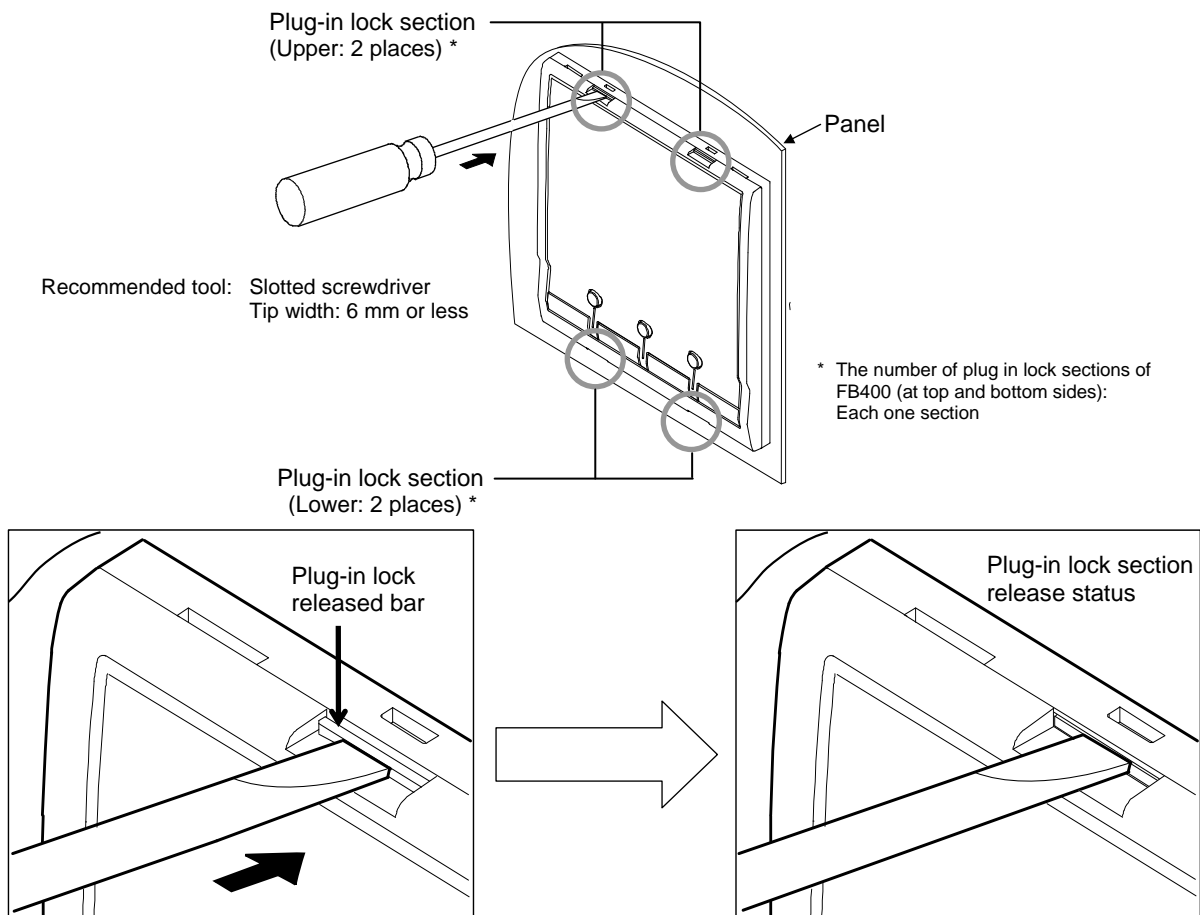

2. Insert the screwdriver in the case lock section as shown in the following figure, and then lightly turn the screwdriver to release the case lock section. The case lock section is released.

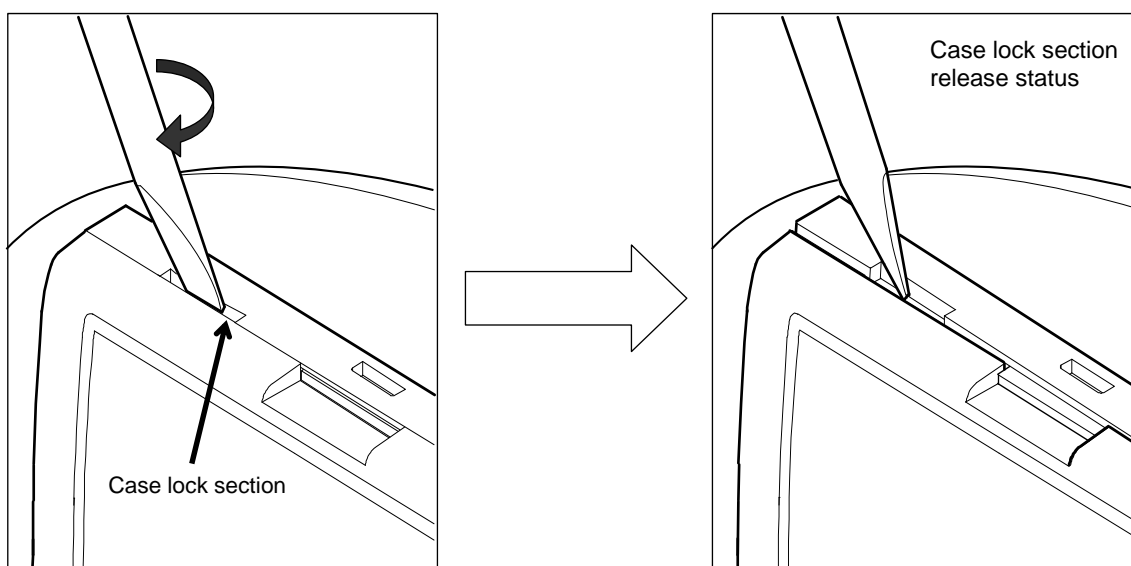
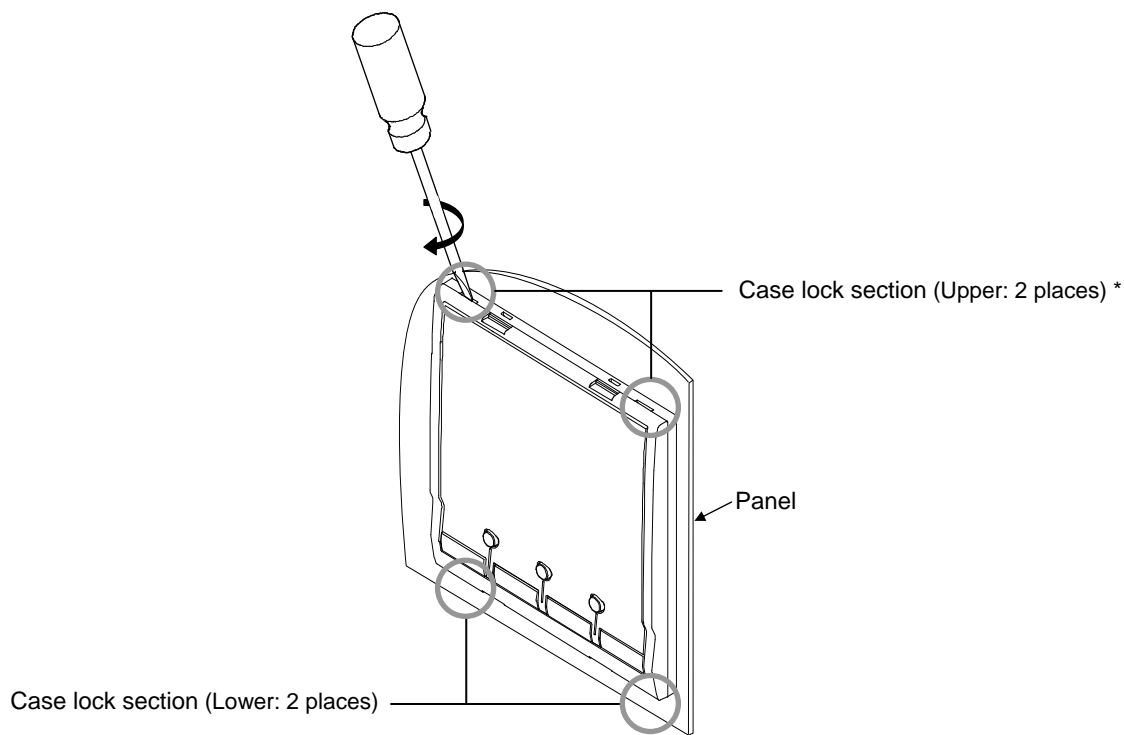

3. The other case lock section should be released the same way described in steps *1* and *2*.
4. Remove the internal assembly from the case.

B. Replacing the Waterproof/Dustproof Rubber Packing

If the waterproof and dustproof rubber packing deteriorates, please contact RKC sales office or the agent. To replace the rubber packing, take the following steps:

WARNING

- In order to prevent electric shock and instrument failure, always turn off the power supply before replacing the rubber packing.
- In order to prevent electric shock and instrument failure, always turn off the power supply before pulling out the internal chassis.
- In order to prevent injury or instrument failure, do not touch the internal printed circuit board.

■ Replacement of the case rubber packing

1. Turn the power OFF.
2. Remove the wiring.
3. Remove the mounting bracket, and then remove the instrument from the control panel.
 -  Refer to **3.3 Procedures of Mounting and Removing (P. 3-4)**.
4. Remove the old rubber packing, and then replace the old rubber packing with a new one.

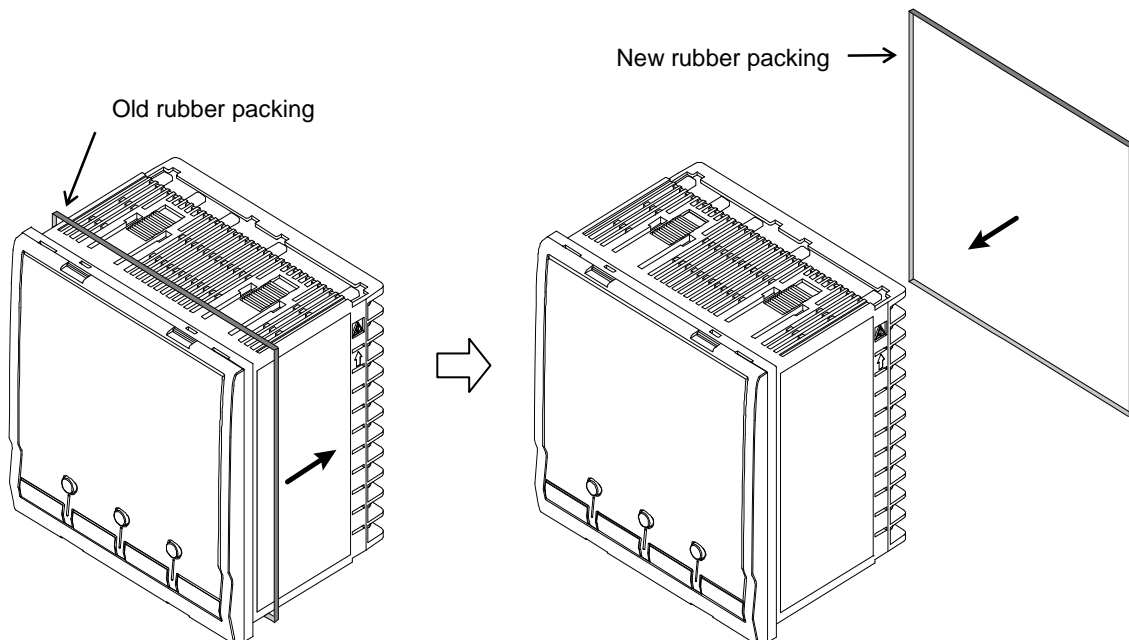

Parts list

	FB400	FB900
Parts code	KFB400-36 <1>	KFB900-36 <1>
Ordering code	00421214	00421248

■ Replacement of the board rubber packing

1. Turn the power OFF.
2. Remove the internal assembly from the case.
 - ☞ Refer to **APPENDIX A. Removing the Internal Assembly (P. A-2)**.
3. Remove the old rubber packing, and then replace the old rubber packing with a new one.

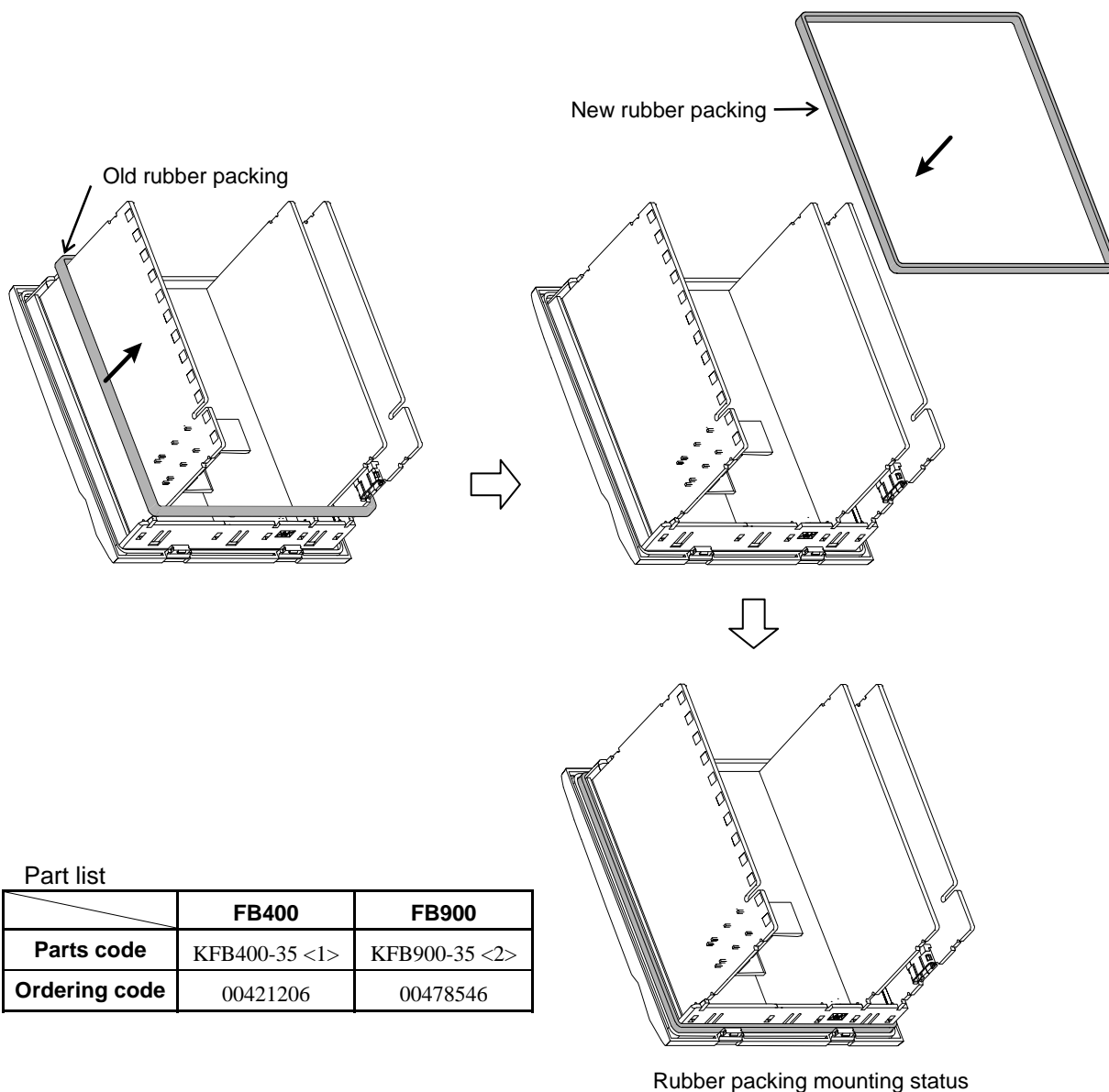

4. Insert the internal assembly in the case.

C. Transformer Dimensions for Power Feed Forward

■ Model code

PFT-01 (100 to 120 V AC)

PFT-02 (200 to 240 V AC)

■ Dimensions and mounting dimensions

(Unit: mm)

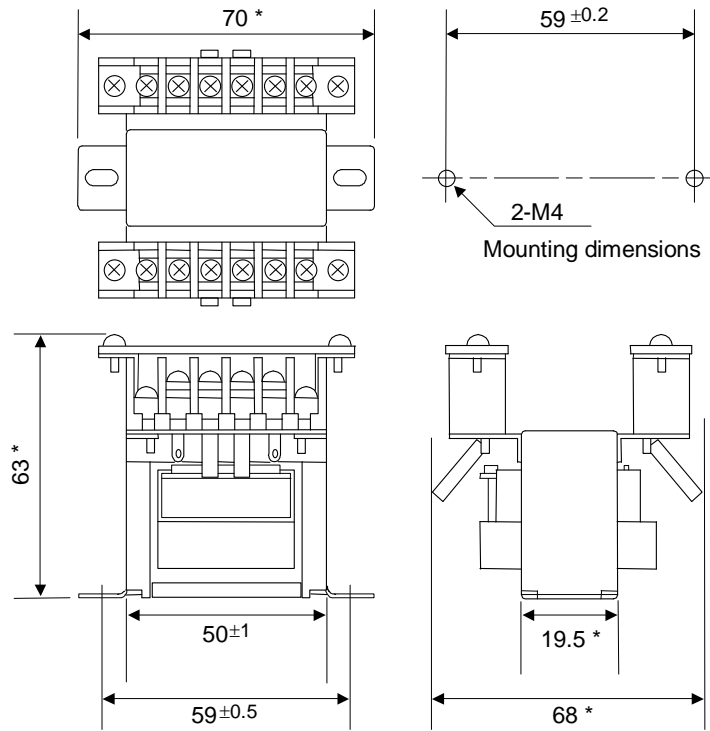

* Maximum

■ Terminal configuration

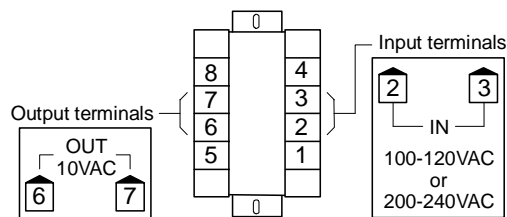

D. Current Transformer (CT) Dimensions

■ CTL-6-P-N (For 0 to 30 A)

(Unit: mm)

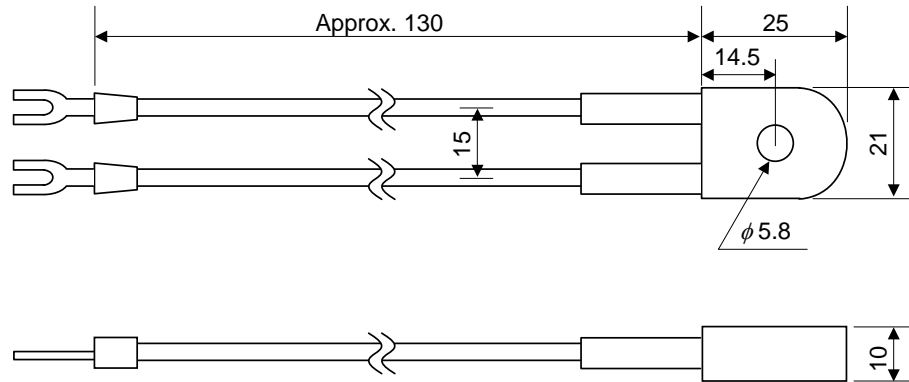

■ CTL-12-S56-10L-N (For 0 to 100 A)

(Unit: mm)

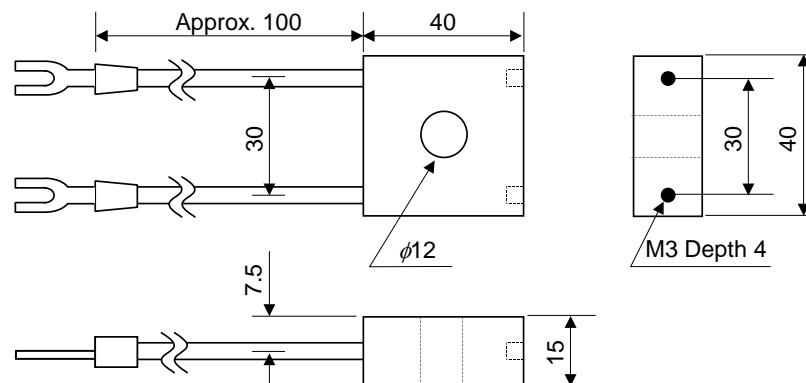

E. Memory Area Data List

(Copy this sheet for its use.)

Sheet No.	Memory area No.	Date	Name	
Display	Item	Set value	Memo	
SV	Set value (SV)			
EV1	Event 1 set value (EV1)			
EV2	Event 2 set value (EV2)			
EV3	Event 3 set value (EV3)			
EV4	Event 4 set value (EV4)			
LbA	Control loop break alarm (LBA) time			
Lbd	LBA deadband			
P	Proportional band [heat-side]			
I	Integral time [heat-side]			
d	Derivative time [heat-side]			
rPF	Control response parameter			
Pc	Proportional band [cool-side]			
Ic	Integral time [cool-side]			
dc	Derivative time [cool-side]			
db	Overlap/Deadband			
nr	Manual reset			
SV-U	Setting change rate limiter (up)			
SV-d	Setting change rate limiter (down)			
ASF	Area soak time			
LnLA	Link area number			

Ramp/Soak control	1	2	3	4	5	6	7	8
<p>A1 to A3: Soak time B1 to B3: Setting change rate limiter</p>								
Link area number								
Area soak time								
Setting change rate limiter (up)								
Setting change rate limiter (down)								

F. Parameter List

■ SV setting & monitor mode

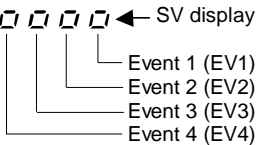
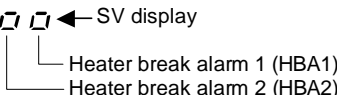
Symbol	Name	Data range	Factory set value	User set value	Page
—	Measured value (PV)/ Set value (SV) monitor	PV display: Input scale low to Input scale high * SV display: • SV * • Remote setting (RS) input value * • Manual manipulated output value * Varies with the setting of the Decimal point position	—		7-5
SV	Set value (SV) ¹	Setting limiter low to Setting limiter high [Varies with the setting of the Decimal point position]	0		7-7
CT1	Current transformer 1 (CT1) input value monitor ²	0.0 to 30.0 A or 0.0 to 100.0 A	—		7-7
CT2	Current transformer 2 (CT2) input value monitor ³	0.0 to 30.0 A or 0.0 to 100.0 A	—		7-7
SVr	Remote setting (RS) input value monitor	Setting limiter low to Setting limiter high [Varies with the setting of the Decimal point position]	—		7-7
EVn1	Event monitor 1 ⁴	 ← SV display Event 1 (EV1) Event 2 (EV2) Event 3 (EV3) Event 4 (EV4)	—		7-8
EVn2	Event monitor 2 ⁵	 ← SV display Heater break alarm 1 (HBA1) Heater break alarm 2 (HBA2)	—		7-8
MV	Manipulated output value (MV1) monitor [heat-side] ⁶	PID control or Heat/Cool PID control: -5.0 to +105.0 % Position proportioning PID control: When the control motor with Feedback resistance (FBR) is used: 0.0 to 100.0 %	—		7-9
MV2	Manipulated output value (MV2) monitor [cool-side] ⁷	-5.0 to +105.0 %	—		7-10
APT	Memory area soak time monitor	0 minutes 00 seconds to 199 minutes 59 seconds or 0 hours 00 minutes to 99 hours 59 minutes	—		7-10
ArE	Memory area transfer	1 to 8	1		7-11

¹ Parameters related to multi-memory area function

² Displayed only when the CT1 input is provided.

³ Displayed only when the CT2 input is provided.

⁴ Displayed when the Event action is selected for any one of the Event types from 1 to 4.

⁵ Display when the CT1 or CT2 input is provided. This screen is not displayed when set the CT assignment to "0: None."

⁶ MV1 of heat-side is not displayed when the control action is Position proportioning PID control and the input of Feedback resistance (FBR) is not used.

⁷ This screen is displayed when the control action is Heat/Cool PID control.

Continued on the next page.

Continued from the previous page.

Symbol	Name	Data range	Factory set value	User set value	Page
$P\bar{S}\bar{n}'$	Manipulated output value at MV transfer ¹	PID control: Output limiter low [MV1] to Output limiter high [MV1] Heat/cool PID control: -Output limiter high [MV2] to +Output limiter high [MV1] For overlap: -105.0 to +105.0 % * * Actual output value is limited by the output limiter function.	0.0		7-11
$I\bar{L}\bar{r}$	Interlock release ²	on: Interlock oFF: Interlock release	oFF		7-13

¹ This screen is not displayed when set the MV transfer function to "0."² Not displayed when Event 1, 2, 3 or 4 interlock function is not used.

■ Operation mode

Symbol	Name	Data range	Factory set value	User set value	Page
$A\bar{r}\bar{U}$	PID/AT transfer	on: Autotunig (AT) oFF: PID control	oFF		6-15 7-15
$S\bar{r}\bar{U}$	Startup tuning (ST) ¹	on1: Execute once on2: Execute always oFF: ST unused	oFF		6-18 7-16
$C\bar{H}\bar{r}$	Automatic temperature rise learning ²	on: Learning oFF: Unused	on		6-72 7-17
$A-\bar{n}$	Auto/Manual transfer	AUTo: Auto mode MAAn: Manual mode	AUTo		6-23 7-17
$r-L$	Remote/Local transfer	LoC: Local mode rEM: Remote mode	LoC		6-28 7-18
$r-S$	RUN/STOP transfer	rUN: RUN mode (Control start) SToP: STOP mode (Control stop)	rUn		6-11 7-18

¹ This screen is not displayed when the control action is Position proportioning PID control.² This screen is not displayed when set the Automatic temperature rise group to "0."

■ Parameter setting mode

Symbol	Name	Data range	Factory set value	User set value	Page
<i>EV1</i>	Event 1 set value (EV1) ^{1,2}	Deviation: –Input span to +Input span [Varies with the setting of the Decimal point position] Process and set value: Input scale low to Input scale high [Varies with the setting of the Decimal point position] Manipulated output value (MV1 or MV2): –5.0 to +105.0 %	50		7-21
<i>EV2</i>	Event 2 set value (EV2) ^{1,2}		50		7-21
<i>EV3</i>	Event 3 set value (EV3) ^{1,2}		50		7-21
<i>EV4</i>	Event 4 set value (EV4) ^{1,2,3}		50		7-21
<i>LbA</i>	Control loop break alarm (LBA) time ^{1,4}	1 to 7200 seconds oFF: Unused	480		7-22
<i>LbD</i>	LBA deadband ^{1,4}	0 to Input span [Varies with the setting of the Decimal point position]	0		7-23
<i>P</i>	Proportional band ¹ [heat-side]	TC/RTD inputs: 0 (0.0, 0.00) to Input span (Unit: °C [°F]) [Varies with the setting of the Decimal point position] Voltage (V)/Current (I) inputs: 0.0 to 1000.0 % of Input span 0 (0.0, 0.00): ON/OFF action	TC/RTD: 30 V/I: 30.0		7-24
<i>I</i>	Integral time ¹ [heat-side]	PID control or Heat/Cool PID control: 1 to 3600 seconds or 0.1 to 1999.9 seconds oFF: PD action [both heat-side and cool-side] Position proportioning PID control: 1 to 3600 seconds or 0.1 to 1999.9 seconds [Varies with the setting of the Integral/ Derivative decimal point position]	240		7-25
<i>D</i>	Derivative time ¹ [heat-side]	1 to 3600 seconds or 0.1 to 1999.9 seconds oFF: PI action [Varies with the setting of the Integral/ Derivative decimal point position]	60		7-25
<i>rPF</i>	Control response parameter ¹	0: Slow 1: Medium 2: Fast When the P or PD action is selected, this setting becomes invalid.	PID control, Position proportioning PID control: 0 Heat/Cool PID control: 2		7-26
<i>Pc</i>	Proportional band ^{1,5} [cool-side]	TC/RTD inputs: 1 (0.1, 0.01) to Input span (Unit: °C [°F]) [Varies with the setting of the Decimal point position] Voltage (V)/Current (I) inputs: 0.1 to 1000.0 % of Input span	TC/RTD: 30 V/I: 30.0		7-27

¹ Parameters related to Multi-memory area function

² Not displayed when Event function is not used.

³ EV4 is not displayed when the Event 4 is used as an LBA.

⁴ This screen is displayed when the Event 4 is used as an LBA.

⁵ This screen is displayed when the control action is Heat/Cool PID control.

Continued on the next page.

Continued from the previous page.

Symbol	Name	Data range	Factory set value	User set value	Page
<i>ic</i>	Integral time ^{1,2} [cool-side]	1 to 3600 seconds or 0.1 to 1999.9 seconds oFF: PD action [Varies with the setting of the Integral/ Derivative decimal point position]	240		7-27
<i>dc</i>	Derivative time ^{1,2} [cool-side]	1 to 3600 seconds or 0.1 to 1999.9 seconds oFF: PI action [Varies with the setting of the Integral/ Derivative decimal point position]	60		7-28
<i>db</i>	Overlap/Deadband ^{1,2}	TC/RTD inputs: –Input span to +Input span (Unit:°C [°F]) Voltage (V)/Current (I) inputs: –100.0 to +100.0 % of Input span Minus (–) setting results in Overlap. However, the overlapping range is within the proportional range.	0		7-29
<i>nr</i>	Manual reset ^{1,3}	–100.0 to +100.0 %	0.0		7-30
<i>SbrU</i>	Setting change rate limiter (up) ¹	1 (0.1, 0.01) to Input span/unit time oFF: Unused	oFF		7-31
<i>Sbrd</i>	Setting change rate limiter (down) ¹	[Varies with the setting of the Decimal point position]	oFF		7-31
<i>ASr</i>	Area soak time ¹	0 minutes 00 seconds to 199 minutes 59 seconds or 0 hours 00 minutes to 99 hours 59 minutes	0:00		7-32
<i>LnEA</i>	Link area number ¹	1 to 8 oFF: No link	oFF		7-33

¹ Parameters related to Multi-memory area function² This screen is displayed when the control action is Heat/Cool PID control.³ The screen is displayed when the Integral time [heat-side] or Integral time [cool-side] is set to “oFF.”

■ Setup setting mode

Symbol	Name	Data range	Factory set value	User set value	Page
<i>HbA1</i>	Heater break alarm 1 (HBA1) set value ^{a, b}	When CT is CTL-6-P-N: 0.1 to 30.0 A oFF: Not used When CT is CTL-12-S56-10L-N: 0.1 to 100.0 A oFF: Not used	oFF		7-35
<i>HbL1</i>	Heater break determination point 1 ^{a, b, c}	0.1 to 100.0 % of HBA1 set value oFF: Heater break determination is invalid	30.0		7-38
<i>HbH1</i>	Heater melting determination point 1 ^{a, b, c}	0.1 to 100.0 % of HBA1 set value oFF: Heater melting determination is invalid	30.0		7-39
<i>HbA2</i>	Heater break alarm 2 (HBA2) set value ^{d, e}	When CT is CTL-6-P-N: 0.1 to 30.0 A oFF: Not used When CT is CTL-12-S56-10L-N: 0.1 to 100.0 A oFF: Not used	oFF		7-35
<i>HbL2</i>	Heater break determination point 2 ^{d, e, f}	0.1 to 100.0 % of HBA2 set value oFF: Heater break determination is invalid	30.0		7-38
<i>HbH2</i>	Heater melting determination point 2 ^{d, e, f}	0.1 to 100.0 % of HBA2 set value oFF: Heater melting determination is invalid	30.0		7-39
<i>Pb</i>	PV bias	-Input span to +Input span [Varies with the setting of the Decimal point position]	0		7-40
<i>dF</i>	PV digital filter	0.1 to 100.0 seconds oFF: Unused	oFF		7-40
<i>Pr</i>	PV ratio	0.500 to 1.500	1.000		7-40
<i>PLC</i>	PV low input cut-off	0.00 to 25.00 % of input span	0.00		7-41
<i>rb</i>	RS bias ^g	-Input span to +Input span [Varies with the setting of the Decimal point position]	0		7-42
<i>dF2</i>	RS digital filter ^g	0.1 to 100.0 seconds oFF: Unused	oFF		7-42
<i>rr</i>	RS ratio ^g	0.001 to 9.999	1.000		7-42
<i>f</i>	Proportional cycle time [heat-side]	0.1 to 100.0 seconds	20.0 ^h		7-43
<i>t</i>	Proportional cycle time [cool-side]	0.1 to 100.0 seconds	20.0 ^h		7-43
<i>Add1</i>	Device address 1 ⁱ	0 to 99	0		7-44
<i>bPS1</i>	Communication speed 1 ⁱ	2.4: 2400 bps 4.8: 4800 bps 9.6: 9600 bps 19.2: 19200 bps 38.4: 38400 bps	19.2		7-44

^a Displayed when the CT1 is provided.

^b This screen is not displayed when set the CT1 assignment to "0: None."

^c Displayed when the HBA1 type is type B.

^d Displayed when the CT2 is provided.

^e This screen is not displayed when set the CT2 assignment to "0: None."

^f Displayed when the HBA2 type is type B.

^g Displayed when the Remote setting (RS) is provided.

^h Factory set value varies depending on the instrument specification.

ⁱ Displayed only when the Communication 1 is provided.

Continued on the next page.

Continued from the previous page.

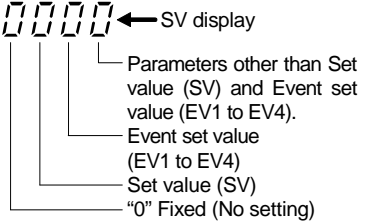
Symbol	Name	Data range	Factory set value	User set value	Page																																																							
<i>b1r1</i>	Data bit configuration 1 ^a	<table border="1"> <thead> <tr> <th rowspan="2"></th> <th colspan="3">Bit configuration</th> </tr> <tr> <th>Data</th> <th>Stop</th> <th>Parity</th> </tr> </thead> <tbody> <tr> <td>8n1</td> <td>8</td> <td>1</td> <td>Without</td> </tr> <tr> <td>8n2</td> <td>8</td> <td>2</td> <td>Without</td> </tr> <tr> <td>8E1</td> <td>8</td> <td>1</td> <td>Even</td> </tr> <tr> <td>8E2</td> <td>8</td> <td>2</td> <td>Even</td> </tr> <tr> <td>8o1</td> <td>8</td> <td>1</td> <td>Odd</td> </tr> <tr> <td>8o2</td> <td>8</td> <td>2</td> <td>Odd</td> </tr> <tr> <td>7n1 *</td> <td>7</td> <td>1</td> <td>Without</td> </tr> <tr> <td>7n2 *</td> <td>7</td> <td>2</td> <td>Without</td> </tr> <tr> <td>7E1 *</td> <td>7</td> <td>1</td> <td>Even</td> </tr> <tr> <td>7E2 *</td> <td>7</td> <td>2</td> <td>Even</td> </tr> <tr> <td>7o1 *</td> <td>7</td> <td>1</td> <td>Odd</td> </tr> <tr> <td>7o2 *</td> <td>7</td> <td>2</td> <td>Odd</td> </tr> </tbody> </table> <p>* When the Modbus communication protocol selected, this setting becomes invalid.</p>		Bit configuration			Data	Stop	Parity	8n1	8	1	Without	8n2	8	2	Without	8E1	8	1	Even	8E2	8	2	Even	8o1	8	1	Odd	8o2	8	2	Odd	7n1 *	7	1	Without	7n2 *	7	2	Without	7E1 *	7	1	Even	7E2 *	7	2	Even	7o1 *	7	1	Odd	7o2 *	7	2	Odd	8n1		7-45
	Bit configuration																																																											
	Data	Stop	Parity																																																									
8n1	8	1	Without																																																									
8n2	8	2	Without																																																									
8E1	8	1	Even																																																									
8E2	8	2	Even																																																									
8o1	8	1	Odd																																																									
8o2	8	2	Odd																																																									
7n1 *	7	1	Without																																																									
7n2 *	7	2	Without																																																									
7E1 *	7	1	Even																																																									
7E2 *	7	2	Even																																																									
7o1 *	7	1	Odd																																																									
7o2 *	7	2	Odd																																																									
<i>Int1</i>	Interval time 1 ^a	0 to 250 ms	10		7-46																																																							
<i>Addr2</i>	Device address 2 ^b	0 to 99	0		7-44																																																							
<i>bPS2</i>	Communication speed 2 ^{b,c}	2.4: 2400 bps 4.8: 4800 bps 9.6: 9600 bps 19.2: 19200 bps 38.4: 38400 bps	19.2		7-44																																																							
<i>b1r2</i>	Data bit configuration 2 ^{b,c}	Same as the Data bit configuration 1	8n1		7-45																																																							
<i>Int2</i>	Interval time 2 ^{b,c}	0 to 250 ms	10		7-46																																																							
<i>LLL</i>	Set lock level	0: Unlock 1: Lock Set to "0" or "1" for each digit. 	0000		7-47																																																							

^a Displayed only when the Communication 1 is provided.

^b Displayed only when the Communication 2 is provided.

^c This screen is not displayed when the Intercontroller communication function is selected.

■ Engineering mode

Parameters in Engineering mode are settable only when the controller is in STOP mode. However, it is possible to check only the data even in RUN mode.

There are invalid parameters when no optional function is specified.

Symbol	Name	Data range	Factory set value	User set value	Page
F 10.	Function block 10	This is first parameter symbol of Function block 10.			
<i>SPCH</i>	STOP display	0: "SToP" is displayed on the PV display. 1: "SToP" is displayed on the SV display.	1		7-62
<i>dE</i>	Bar graph display	0: No display 4: Deviation value 1: MV 5: CT1 input value 2: PV 6: CT2 input value 3: SV monitor	1		7-63
<i>dEUR</i>	Bar graph display resolution	1 to 100 digit/dot	100		7-65
<i>dSoP</i>	PV flashing display at input error	0: Flashing display 1: Non-flashing display	0		7-66
F 11.	Function block 11	This is first parameter symbol of Function block 11.			
<i>F n 1</i>	Direct key 1	0: Unused 1: A/M transfer key (Type 1, Type 2)	1		7-67
<i>F n 2</i>	Direct key 2	0: Unused 1: MONI key (For Type 1) or R/L transfer key (For Type 2)	1		7-67
<i>F n 3</i>	Direct key 3	0: Unused 1: AREA key (For Type 1) or RUN/STOP transfer key (For Type 2)	1		7-68
<i>F n</i>	Direct key type	1: Type 1 2: Type 2	1		7-68
F 21.	Function block 21	This is first parameter symbol of Function block 21.			
<i>I n P</i>	Input type	0: TC input K 1: TC input J 2: TC input R 3: TC input S 4: TC input B 5: TC input E 6: TC input N 7: TC input T 8: TC input W5Re/W26Re 9: TC input PLII 10: TC input U 11: TC input L 12: RTD input Pt100 13: RTD input JPt100 14: Current input 0 to 20 mA DC 15: Current input 4 to 20 mA DC 16: Voltage (high) input 0 to 10 V DC 17: Voltage (high) input 0 to 5 V DC 18: Voltage (high) input 1 to 5 V DC 19: Voltage (low) input 0 to 1 V DC 20: Voltage (low) input 0 to 100 mV DC 21: Voltage (low) input 0 to 10 mV DC 24: Voltage (high) input ±1 V DC 25: Voltage (low) input ±100 mV DC 26: Voltage (low) input ±10 mV DC	0 ^a		7-69

^a Factory set value varies depending on the instrument specification.

Continued on the next page.

Continued from the previous page.

Symbol	Name	Data range	Factory set value	User set value	Page
<i>Unif</i>	Display unit	0: °C 1: °F Use to select the temperature unit for Thermocouple (TC) and RTD inputs.	0 ^a		7-71
<i>PCdP</i>	Decimal point position	0: No decimal place 1: One decimal place 2: Two decimal places 3: Three decimal places 4: Four decimal places TC input: K, J, E: Only 0 or 1 can be set. T, U, L: Only 1 can be set. Other than the above: Only 0 can be set. RTD input: From 0 to 2 can be set. V/I inputs: From 0 to 4 can be set.	0 ^a		7-71
<i>PCSH</i>	Input scale high	TC/RTD inputs: Input scale low to Maximum value of the selected input range Voltage (V)/Current (I) inputs: -19999 to +19999 [Varies with the setting of the Decimal point position]	Maximum value of the selected input range ^a		7-72
<i>PCSL</i>	Input scale low	TC/RTD inputs: Minimum value of the selected input range to Input scale high Voltage (V)/Current (I) inputs: -19999 to +19999 [Varies with the setting of the Decimal point position]	Minimum value of the selected input range ^a		7-72
<i>POH</i>	Input error determination point (high)	Input scale low – (5 % of input span) to Input scale high + (5 % of input span)	Input scale high + (5 % of input span) ^a		7-74
<i>PUN</i>	Input error determination point (low)	[Varies with the setting of the Decimal point position]	Input scale low – (5 % of input span) ^a		7-74
<i>boS</i>	Burnout direction	0: Upscale 1: Downscale Valid only when the TC input and Voltage (low) input are selected.	0		7-75
<i>Sqr</i>	Square root extraction	0: Unused 1: Used	0		7-75
<i>PFrq</i>	Power supply frequency	0: 50 Hz 1: 60 Hz	0		7-76
<i>SnP</i>	Sampling cycle	0: 50 ms 1: 100 ms 2: 250 ms	1		7-76
<i>F22.</i>	Function block 22	This is first parameter symbol of Function block 22.			
<i>rlnP</i>	Remote setting input type	14: 0 to 20 mA DC 18: 1 to 5 V DC 15: 4 to 20 mA DC 19: 0 to 1 V DC 16: 0 to 10 V DC 20: 0 to 100 mV DC 17: 0 to 5 V DC 21: 0 to 10 mV DC	15 ^a		7-77
<i>F23.</i>	Function block 23	This is first parameter symbol of Function block 23.			
<i>diSL</i>	Digital input (DI) assignment	1 to 8 [Refer to Table 1 (P. A-24).]	1		7-78

^a Factory set value varies depending on the instrument specification.

Continued on the next page.

Continued from the previous page.

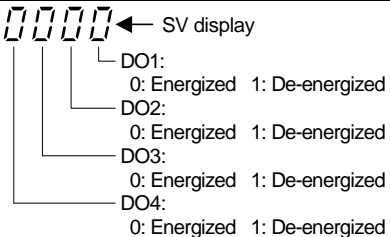
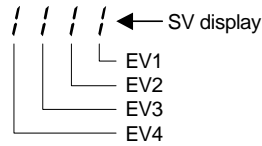
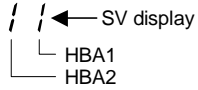
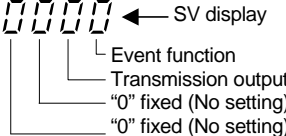
Symbol	Name	Data range	Factory set value	User set value	Page
F30.	Function block 30	This is first parameter symbol of Function block 30.			
L000	Output assignment	1 to 7 [Refer to Table 2 (P. A-24).]	2		7-79
OFF1	Timer 1	0.0 to 600.0 seconds	0.0		7-80
OFF2	Timer 2		0.0		7-80
OFF3	Timer 3		0.0		7-80
OFF4	Timer 4		0.0		7-80
EYC	Energized/De-energized		0000		7-80
ALC1	Alarm (ALM) lamp lighting condition 1 ^a	0: ALM lamp is not lit 1: ALM lamp is lit 	1111		7-81
ALC2	Alarm (ALM) lamp lighting condition 2 ^a	0: ALM lamp is not lit 1: ALM lamp is lit 	0011		7-81
SS	Output status at STOP mode	0: OFF 1: Action continued 	0000		7-82
F33.	Function block 33	This is first parameter symbol of Function block 33.			
Ro	Transmission output type	0: None 1: PV 2: Set value (SV) monitor 3: Deviation value 4: MV1 [heat-side] 5: MV2 [cool-side] 6: Set value (SV) 7: Remote setting (RS) input value	1		7-83
RHS	Transmission output scale high	When the PV, SV, SV monitor and RS: Input scale low to Input scale high [Varies with the setting of the Decimal point position]	Input scale high		7-84
RLS	Transmission output scale low	When the MV1 and MV2: -5.0 to +105.0 % When the deviation value: -Input span to +Input span	Input scale low		7-84

^a The ALM lamp is lit through the OR operation of EV1, EV2, EV3, EV4, HBA1 and HBA2 each of which is set to “1: ALM lamp is lit.”

Continued on the next page.

Continued from the previous page.

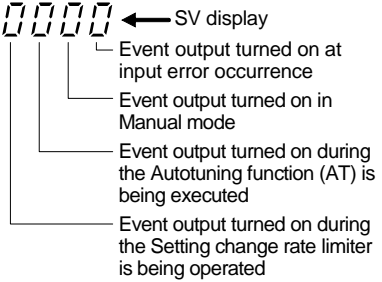
Symbol	Name	Data range	Factory set value	User set value	Page
F41.	Function block 41	This is first parameter symbol of Function block 41.			
<i>ES1</i>	Event 1 type	0: None 1: Deviation high ¹ 2: Deviation low ¹ 3: Deviation high/low ¹ 4: Band ¹ 5: Process high ¹ 6: Process low ¹ 7: SV high 8: SV low 9: Unused 10: MV1 high [heat-side] ^{1,2} 11: MV1 low [heat-side] ^{1,2} 12: MV2 high [cool-side] ¹ 13: MV2 low [cool-side] ¹ ¹ Event hold action is available. ² Feedback resistance (FBR) input value is displayed when the control motor with Feedback resistance (FBR) is used.	0 ^a		7-85
<i>EHo1</i>	Event 1 hold action	0: OFF 2: Re-hold action ON 1: Hold action ON	0 ^a		7-87
<i>EIL1</i>	Event 1 interlock	0: Unused 1: Used	0		7-89
<i>EH1</i>	Event 1 differential gap	Deviation, process or set value: 0 to Input span [Varies with the setting of the Decimal point position] MV: 0.0 to 110.0 %	2 ^a		7-90
<i>EHF1</i>	Event 1 delay timer	0.0 to 600.0 seconds	0.0		7-91
<i>EEo1</i>	Force ON of Event 1 action	0: Invalid 1: Valid 	0000		7-93
F42.	Function block 42	This is first parameter symbol of Function block 42.			
<i>ES2</i>	Event 2 type	Same as Event 1 type			7-95
<i>EHo2</i>	Event 2 hold action	Same as Event 1 hold action			7-97
<i>EIL2</i>	Event 2 interlock	Same as Event 1 interlock			7-98
<i>EH2</i>	Event 2 differential gap	Same as Event 1 differential gap			7-99
<i>EHF2</i>	Event 2 delay timer	Same as Event 1 delay timer			7-100
<i>EEo2</i>	Force ON of Event 2 action	Same as Force ON of Event 1 action			7-101
F43.	Function block 43	This is first parameter symbol of Function block 43.			
<i>ES3</i>	Event 3 type	Same as Event 1 type			7-102
<i>EHo3</i>	Event 3 hold action	Same as Event 1 hold action			7-104

^a Factory set value varies depending on the instrument specification.

Continued on the next page.

Continued from the previous page.

Symbol	Name	Data range	Factory set value	User set value	Page
<i>E1L3</i>	Event 3 interlock	Same as Event 1 interlock			7-105
<i>EH3</i>	Event 3 differential gap	Same as Event 1 differential gap			7-106
<i>EHF3</i>	Event 3 delay timer	Same as Event 1 delay timer			7-107
<i>EEo3</i>	Force ON of Event 3 action	Same as Force ON of Event 1 action			7-108
<i>F44.</i>	Function block 44	This is first parameter symbol of Function block 44.			
<i>ES4</i>	Event 4 type	9: Control loop break alarm (LBA) The other data is the same as an Event 1 type.			7-109
<i>EHo4</i>	Event 4 hold action ^a	Same as Event 1 hold action			7-111
<i>E1L4</i>	Event 4 interlock	Same as Event 1 interlock			7-112
<i>EH4</i>	Event 4 differential gap ^a	Same as Event 1 differential gap The invalidity in case of the LBA.			7-113
<i>EHF4</i>	Event 4 delay timer	Same as Event 1 delay timer			7-114
<i>EEo4</i>	Force ON of Event 4 action ^a	Same as Force ON of Event 1 action			7-115
<i>F45.</i>	Function block 45	This is first parameter symbol of Function block 45.			
<i>CFr1</i>	CT1 ratio	0 to 9999 CT type: CTL-6-P-N CTL-12-S56-10L-N	800 ^b		7-116
<i>CFR1</i>	CT1 assignment	0: None 2: OUT2 1: OUT1 3 to 6: Do not set this one	1		7-117
<i>HbS1</i>	Heater break alarm 1 (HBA1) type	0: Heater break alarm 1 (HBA1) type A 1: Heater break alarm 1 (HBA1) type B	0 ^b		7-117
<i>HbC1</i>	Number of heater break alarm 1 (HBA1) delay times	0 to 255	5		7-119
<i>F46.</i>	Function block 46.	This is first parameter symbol of Function block 46.			
<i>CFr2</i>	CT2 ratio	0 to 9999 CT type: CTL-6-P-N CTL-12-S56-10L-N	800 ^b		7-120
<i>CFR2</i>	CT2 assignment	0: None 2: OUT2 1: OUT1 3 to 6: Do not set this one	0		7-121
<i>HbS2</i>	Heater break alarm 2 (HBA2) type	0: Heater break alarm 2 (HBA2) type A 1: Heater break alarm 2 (HBA2) type B	0		7-122
<i>HbC2</i>	Number of heater break alarm 2 (HBA2) delay times	0 to 255	5		7-122
<i>F50.</i>	Function block 50	This is first parameter symbol of Function block 50.			
<i>Pb</i>	Hot/Cold start	0: Hot start 1 1: Hot start 2 2: Cold start 3: Stop start	0		7-123
<i>PbA</i>	Start determination point	0 to Input span (The unit is the same as input value.) (0: Action depending on the Hot/Cold start selection) [Varies with the setting of the Decimal point position]	3 % of input span		7-124
<i>CA\bar{n}</i>	External input type	0: Remote setting (RS) input 1: Intercontroller communication cascade control 2: Intercontroller communication ratio setting	0		7-125

^a When the Control loop break alarm (LBA) is selected, the setting becomes invalid.^b Factory set value varies depending on the instrument specification.

Continued on the next page.

Continued from the previous page.

Symbol	Name	Data range	Factory set value	User set value	Page
$\bar{n}CH$	Master channel selection	0 to 31	0		7-126
$\bar{r}rE$	SV tracking	0: Unused 1: Used	1		7-127
$\bar{n}MFS$	MV transfer function [Action taken when changed to Manual mode from Auto mode]	0: MV1 or MV2 in Auto mode is used. 1: When selected by Digital input (DI): MV1 or MV2 in previous Manual mode is used. When selected by front key: MV1 or MV2 in Auto mode is used. 2: MV1 or MV2 in previous Manual mode is used.	0		7-128
$\bar{P}MFS$	PV transfer function	0: Unused 1: Used	0		7-128
FS1.	Function block 51	This is first parameter symbol of Function block 51.			
$\bar{o}S$	Control action	0: Brilliant II PID control (direct action) 1: Brilliant II PID control (reverse action) 2: Brilliant II Heat/Cool PID control [water cooling] 3: Brilliant II Heat/Cool PID control [air cooling] 4: Brilliant II Heat/Cool PID control [Cooling gain linear type] 5: Position proportioning PID control (reverse action) 6: Position proportioning PID control (direct action)	1 ^a		7-129
$\bar{i}ddP$	Integral/derivative time decimal point position	0: 1 second setting (No decimal place) 1: 0.1 seconds setting (One decimal place)	0		7-133
$\bar{d}GR$	Derivative gain	0.1 to 10.0	6.0		7-133
$\bar{o}HH$	ON/OFF action differential gap (upper)	TC/RTD inputs: 0.0 to Input span (Unit: °C [°F]) [Varies with the setting of the Decimal point position]	1 ^a		7-134
$\bar{o}HL$	ON/OFF action differential gap (lower)	Voltage (V)/Current (I) inputs: 0.0 to 100.0 % of input span	1 ^a		7-134
$\bar{A}oBE$	Action (high) at input error	0: Normal control 1: Manipulated output value at input error	0		7-135
$\bar{A}UnE$	Action (low) at input error		0		7-135
$\bar{P}S\bar{n}$	Manipulated output value at input error	-105.0 to +105.0 %	0.0		7-136
$\bar{r}\bar{n}B1$	Manipulated output value (MV1) at STOP mode	-5.0 to +105.0 %	-5.0		7-136
$\bar{r}\bar{n}B2$	Manipulated output value (MV2) at STOP mode		-5.0		7-136
$\bar{o}rU$	Output change rate limiter (up) [MV1]	0.0 to 100.0 %/seconds of Manipulated output	0.0		7-137
$\bar{o}rD$	Output change rate limiter (down) [MV1]	(0.0: OFF)	0.0		7-137
$\bar{o}LH$	Output limiter high (MV1)	Output limiter low (MV1) to 105.0 %	105.0		7-138
$\bar{o}LL$	Output limiter low (MV1)	-5.0 % to Output limiter high (MV1)	-5.0		7-138
$\bar{o}rU2$	Output change rate limiter (up) [MV2]	Same as Output change rate limiter (up) [MV1]	0.0		7-137
$\bar{o}rD2$	Output change rate limiter (down) [MV2]	Same as Output change rate limiter (down) [MV1]	0.0		7-137

^a Factory set value varies depending on the instrument specification.

Continued on the next page.

Continued from the previous page.

Symbol	Name	Data range	Factory set value	User set value	Page	
<i>oLH2</i>	Output limiter high (MV2)	Output limiter low (MV2) to 105.0 %	105.0		7-138	
<i>oLL2</i>	Output limiter low (MV2)	-5.0 % to Output limiter high (MV2)	-5.0		7-138	
<i>PFF</i>	Power feed forward selection	0: Unused 1: Used	1		7-140	
<i>PFFS</i>	Power feed forward gain	0.01 to 5.00	1.00		7-141	
<i>dFP</i>	Derivative action	0: Measured value derivative 1: Deviation derivative	0		7-142	
<i>US</i>	Undershoot suppression factor	0.000 to 1.000	1.000 ^a		7-143	
<i>dbPA</i>	Overlap/Deadband reference point	0.0 to 1.0	0		7-144	
<i>F52.</i>	Function block 52	This is first parameter symbol of Function block 52.				
<i>ATb</i>	AT bias	-Input span to +Input span [Varies with the setting of the Decimal point position]	0		7-146	
<i>ATC</i>	AT cycles	0: 1.5 cycles 2: 2.5 cycles 1: 2.0 cycles 3: 3.0 cycles	1		7-147	
<i>ATdH</i>	AT differential gap time	0.0 to 50.0 seconds	10.0		7-148	
<i>ATon</i>	Output value with AT turned on	Output value with AT turned off to 105.0 %	105.0		7-149	
<i>AToF</i>	Output value with AT turned off	-105.0 % to Output value with AT turned on	-105.0		7-149	
<i>PLH</i>	Proportional band limiter (high) [heat-side]	TC/RTD inputs: 0 (0.0, 0.00) to Input span (Unit: °C [°F]) [Varies with the setting of the Decimal point position] Voltage (V)/Current (I) inputs: 0.0 to 1000.0 % of input span	Input span ^a		7-150	
<i>PLL</i>	Proportional band limiter (low) [heat-side]		0 ^a		7-150	
<i>ILH</i>	Integral time limiter (high) [heat-side]	0 to 3600 seconds or 0.0 to 1999.9 seconds [Varies with the setting of the Integral/ Derivative time decimal point position]	3600		7-151	
<i>ILL</i>	Integral time limiter (low) [heat-side]		0		7-151	
<i>dLH</i>	Derivative time limiter (high) [heat-side]		3600		7-152	
<i>dLL</i>	Derivative time limiter (low) [heat-side]		0		7-152	
<i>PcLH</i>	Proportional band limiter (high) [cool-side]		TC/RTD inputs: 1 (0.1, 0.01) to input span (Unit: °C [°F]) [Varies with the setting of the Decimal point position] Voltage (V)/Current (I) inputs: 0.1 to 1000.0 % of input span	Input span ^a		7-153
<i>PcLL</i>	Proportional band limiter (low) [cool-side]			1		7-153
<i>IcLH</i>	Integral time limiter (high) [cool-side]	Same as Integral time limiter (high) [heat-side]	3600		7-154	
<i>IcLL</i>	Integral time limiter (low) [cool-side]	Same as Integral time limiter (low) [heat-side]	0		7-154	
<i>dcLH</i>	Derivative time limiter (high) [cool-side]	Same as Derivative time limiter (high) [heat-side]	3600		7-155	
<i>dcLL</i>	Derivative time limiter (low) [cool-side]	Same as Derivative time limiter (low) [heat-side]	0		7-155	

^a Factory set value varies depending on the instrument specification.

Continued on the next page.

Continued from the previous page.

Symbol	Name	Data range	Factory set value	User set value	Page
<i>PRJ</i>	Proportional band adjusting factor [heat-side]	0.01 to 10.00 times	1.00		7-156
<i>IRJ</i>	Integral time adjusting factor [heat-side]		1.00		7-156
<i>DRJ</i>	Derivative time adjusting factor [heat-side]		1.00		7-157
<i>PCRJ</i>	Proportional band adjusting factor [cool-side]		1.00		7-156
<i>ICRJ</i>	Integral time adjusting factor [cool-side]		1.00		7-156
<i>DCRJ</i>	Derivative time adjusting factor [cool-side]		1.00		7-157
FS3.	Function block 53	This is first parameter symbol of Function block 53.			
<i>Ydb</i>	Open/Close output neutral zone	0.1 to 10.0 % of output	2.0		7-158
<i>YHS</i>	Open/Close output differential gap	0.1 to 5.0 % of output	1.0		7-159
<i>Ybr</i>	Action at feedback resistance (FBR) input error	0: Action depending on the valve action at STOP 1: Control action continued	0		7-159
<i>Pos</i>	Feedback adjustment	At the Adjustment preparation screen, press the shift key for 5 seconds to start the adjustment.	—		7-160
<i>nof</i>	Control motor time	5 to 1000 seconds	10		7-161
<i>oLA</i>	Integrated output limiter	0.0 to 200.0 % of control motor time 0.0: Integrated output limiter function OFF This value becomes invalid when Feedback resistance (FBR) input is used.	150.0		7-161
<i>YAL</i>	Valve action at STOP	0: Close-side output OFF, Open-side output OFF 1: Close-side output ON, Open-side output OFF 2: Close-side output OFF, Open-side output ON	0		7-162
<i>YASo</i>	Action at saturated output	0: Invalid 1: Valid	0		7-162
FS4.	Function block 54	This is first parameter symbol of Function block 54.			
<i>SFS</i>	ST start condition	0: Activate the Startup tuning (ST) function when the power is turned on; when transferred from STOP to RUN; or when the Set value (SV) is changed. 1: Activate the Startup tuning (ST) function when the power is turned on; or when transferred from STOP to RUN. 2: Activate the Startup tuning (ST) function when the Set value (SV) is changed.	0		7-163
<i>SFPE</i>	ST proportional band adjusting factor	0.01 to 10.00 times	1.00		7-163
<i>SFIE</i>	ST integral time adjusting factor		1.00		7-164
<i>SFDE</i>	ST derivative time adjusting factor		1.00		7-164

^a Factory set value varies depending on the instrument specification.

Continued on the next page.

Continued from the previous page.

Symbol	Name	Data range	Factory set value	User set value	Page
F55.	Function block 55	This is first parameter symbol of Function block 55.			
<i>CHrG</i>	Automatic temperature rise group	0 to 16 (0: Automatic temperature rise function OFF)	0		7-165
<i>rSG</i>	RUN/STOP group	0 to 16 (0: RUN/STOP group function OFF)	0		7-166
<i>CHrd</i>	Automatic temperature rise dead time	0.1 to 1999.9 seconds	10.0		7-167
<i>CHrF</i>	Automatic temperature rise gradient data	0.1 to Input span/minutes	1.0		7-167
F60.	Function block 60	This is first parameter symbol of Function block 60.			
<i>CnP1</i>	Communication 1 protocol	0: RKC communication 1: Modbus	0 ^a		7-168
<i>CnP2</i>	Communication 2 protocol	0: RKC communication 1: Modbus 2: Intercontroller communication	2		7-168
F70.	Function block 70	This is first parameter symbol of Function block 70.			
<i>SHrF</i>	Setting change rate limiter unit time	1 to 3600 seconds	60		7-169
<i>SDP</i>	Soak time unit	0: 0 hours 00 minutes to 99 hours 59 minutes 1: 0 minutes 00 seconds to 199 minutes 59 seconds	1		7-169
F71.	Function block 71	This is first parameter symbol of Function block 71.			
<i>SLH</i>	Setting limiter high	Setting limiter low to Input scale high [Varies with the setting of the Decimal point position]	Input scale high		7-170
<i>SLL</i>	Setting limiter low	Input scale low to Setting limiter high [Varies with the setting of the Decimal point position]	Input scale low		7-170
F91.	Function block 91	This is first parameter symbol of Function block 91.			
<i>C277</i>	ROM version monitor	Display the version of loaded software.	—		7-171
<i>OT</i>	Integrated operating time monitor	0 to 19999 hours	—		7-171
<i>TCU</i>	Holding peak value ambient temperature monitor	-10.0 to +100.0 °C	—		7-172
<i>HEAF</i>	Power feed forward input value monitor	0.0 to 160.0 % Display in the percentage of the load voltage (rated value).	—		7-172

^a Factory set value varies depending on the instrument specification.

Table 1: Digital input (DI) assignment

Set value	DI1	DI2	DI3	DI4	DI5	DI6	DI7
1	Memory area number selection (1 to 8)			Memory area set *	Unused	Unused	Unused
2	Memory area number selection (1 to 8)			Memory area set *	RUN/STOP transfer	Remote/Local transfer	Auto/Manual transfer
3	Memory area number selection (1 to 8)			Memory area set *	RUN/STOP transfer	Remote/Local transfer	Interlock release
4	Memory area number selection (1 to 8)			Memory area set *	RUN/STOP transfer	Auto/Manual transfer	Interlock release
5	Memory area number selection (1 to 8)			Memory area set *	Remote/Local transfer	Auto/Manual transfer	Interlock release
6	Memory area number selection (1 to 8)			Memory area set *	RUN/STOP transfer	Unused	Interlock release
7	Memory area number selection (1 to 8)			Memory area set *	Remote/Local transfer	Unused	Interlock release
8	Memory area number selection (1 to 8)			Memory area set *	Auto/Manual transfer	Unused	Interlock release





* Only when ZK-1165 specification was specified, memory area transfer is possible without area set input.
For memory area transfer by ZK-1165 specification, refer to **ZK-1165 Specification (IMR01W08-E□)**.

Table 2: Output assignment

This setting is conducted in Engineering mode.

Set value	OUT1	OUT2	DO1	DO2	DO3	DO4
1	MV1	MV2	EV1	EV2	EV3	EV4
2	MV1	MV2	EV1	EV2	EV3	HBA1, HBA2
3	MV1	MV2	EV1	EV2	HBA1, HBA2	FAIL
4	MV1	MV2	EV1	HBA1, HBA2	EV3	EV4
5	MV1	HBA1, HBA2	EV1	EV2	EV3	EV4
6	MV1	HBA1, HBA2	EV1	EV2	EV3	FAIL
7	MV1	FAIL	EV1	EV2	EV3	EV4

MV1: Manipulated output (control output) [heat-side] EV1: Event 1 EV3: Event 3 HBA1: Heater break alarm 1 FAIL: FAIL output
MV2: Manipulated output (control output) [cool-side] EV2: Event 2 EV4: Event 4 HBA2: Heater break alarm 2

-  “Energized” or “De-energized” of DO1 to DO4 can be changed in Engineering mode.
-  Only “De-energized” is available for the FAIL output. No “Energized” is available.
-  An output logic becomes *OR* output when two or more output functions are assigned to one output.
-  To use for Heat/Cool PID control or Position proportioning PID control, select a set value from 1 to 4.
-  Outputs and Event functions not specified in the model code is not valid if specified.

G. Seal [for Unit and Direct key type 2] (accessory attached)

■ Model code

SAP-306

K	°C	°F	%	N	kg
m	cm	mm	m ³	l	A
mA	V	mV	kW	Hz	m/s
m/min	m/h	mm/s	mm/min	mm/h	t/h
kg/h	m ² /min	m ² /h	m ³ /min	m ³ /h	Nm ³ /h
l/s	l/min	l/h	kPa	MPa	kg/cm ²
kgf/cm ²	mH ₂ O	mmH ₂ O	mmAq	cmHg	mmHg
bar	mbar	psi	Torr	kg/cm ² G	kgf/cm ² G
kcal/s	Gcal/h	Mcal/h	kcal/h	cal/h	kcal/m ² h
%RH	%CO	ppm	pH	rpm	D.P.
°CD.P.	CMH	CHM	× 10	× 10 ²	

} For unit

A/M	R/L	R/S	
A/M	R/L	R/S	SAP-306

For FB400 direct key (Type 2)
For FB900 direct key (Type 2)

■ Usage example of the unit seal

Please use only the unit seal meeting the controlled object.

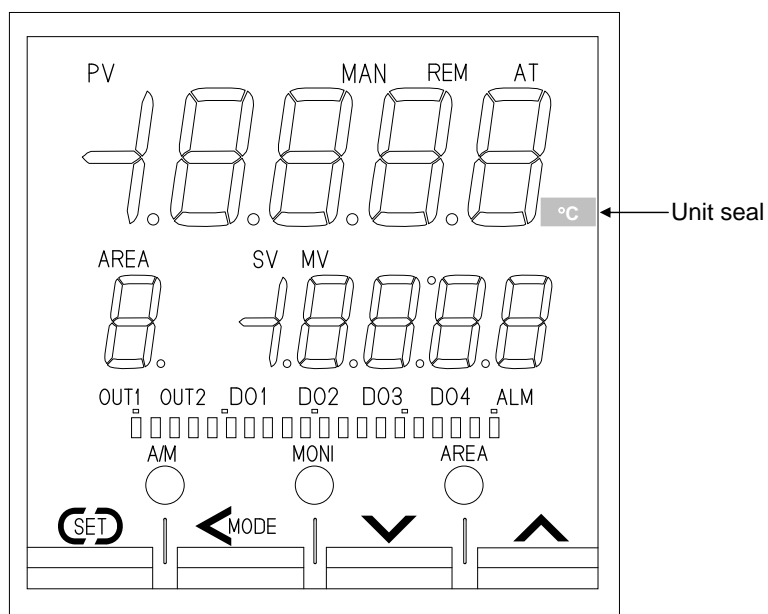

MEMO

Alphabetical Order

A

Action (high) at input error 7-52, 7-135
 Action (low) at input error 7-52, 7-135
 Action at feedback resistance (FBR) input error
 7-53, 7-159
 Action at saturated output 7-53, 7-162
 Alarm (ALM) lamp lighting condition 1 7-49, 7-81
 Alarm (ALM) lamp lighting condition 2 7-49, 7-81
 Area soak time 7-20, 7-32
 AT bias 7-53, 7-146
 AT cycles 7-53, 7-147
 AT differential gap time 7-53, 7-148
 Auto/Manual transfer 6-23, 7-14, 7-17
 Automatic temperature rise dead time 7-54, 7-167
 Automatic temperature rise gradient data 7-54, 7-167
 Automatic temperature rise group 7-54, 7-165
 Automatic temperature rise learning 6-72, 7-14, 7-17

B

Bar graph display 7-48, 7-63
 Bar graph display resolution 7-48, 7-65
 Burnout direction 7-49, 7-75

C

Cascade control function 6-60, 6-82
 Communication 1 protocol 7-54, 7-168
 Communication 2 protocol 7-54, 7-168
 Communication speed 1 7-34, 7-44
 Communication speed 2 7-34, 7-44
 Control action 7-52, 7-129
 Control loop break alarm (LBA) time 7-20, 7-22
 Control motor time 7-53, 7-159
 Control response parameter 7-20, 7-26
 CT1 assignment 7-51, 7-117
 CT1 ratio 7-51, 7-116
 CT2 assignment 7-51, 7-121
 CT2 ratio 7-51, 7-120
 Current transformer 1 (CT1) input value monitor
 7-2, 7-3, 7-7
 Current transformer 2 (CT2) input value monitor
 7-2, 7-3, 7-7

D

Data bit configuration 1 7-34, 7-45
 Data bit configuration 2 7-34, 7-45
 Decimal point position 7-49, 7-71
 Derivative action 7-52, 7-142
 Derivative gain 7-52, 7-133
 Derivative time [cool-side] 7-20, 7-28
 Derivative time [heat-side] 7-20, 7-25
 Derivative time adjusting factor [cool-side] 7-53, 7-157
 Derivative time adjusting factor [heat-side] 7-53, 7-157
 Derivative time limiter (high) [cool-side] 7-53, 7-155
 Derivative time limiter (high) [heat-side] 7-53, 7-152

Derivative time limiter (low) [cool-side] 7-53, 7-155
 Derivative time limiter (low) [heat-side] 7-53, 7-152
 Device address 1 7-34, 7-44
 Device address 2 7-34, 7-44
 Digital input (DI) assignment 7-49, 7-78
 Direct key 1 7-48, 7-67
 Direct key 2 7-48, 7-67
 Direct key 3 7-48, 7-68
 Direct key type 7-48, 7-68
 Display unit 7-49, 7-71

E

Energized/De-energized 7-49, 7-80
 Event 1 delay timer 7-50, 7-91
 Event 1 differential gap 7-50, 7-90
 Event 1 hold action 7-50, 7-87
 Event 1 interlock 7-50, 7-89
 Event 1 set value (EV1) 7-20, 7-21
 Event 1 type 7-50, 7-85
 Event 2 delay timer 7-50, 7-100
 Event 2 differential gap 7-50, 7-99
 Event 2 hold action 7-50, 7-97
 Event 2 interlock 7-50, 7-98
 Event 2 set value (EV2) 7-20, 7-21
 Event 2 type 7-50, 7-95
 Event 3 delay timer 7-50, 7-107
 Event 3 differential gap 7-50, 7-106
 Event 3 hold action 7-50, 7-104
 Event 3 interlock 7-50, 7-105
 Event 3 set value (EV3) 7-20, 7-21
 Event 3 type 7-50, 7-102
 Event 4 delay timer 7-51, 7-114
 Event 4 differential gap 7-51, 7-113
 Event 4 hold action 7-51, 7-111
 Event 4 interlock 7-51, 7-112
 Event 4 set value (EV4) 7-20, 7-21
 Event 4 type 7-51, 7-109
 Event monitor 1 7-2, 7-3, 7-8
 Event monitor 2 7-2, 7-3, 7-8
 External input type 7-51, 7-125

F

Feedback adjustment 7-53, 7-160
 Force ON of Event 1 action 7-50, 7-93
 Force ON of Event 2 action 7-50, 7-101
 Force ON of Event 3 action 7-50, 7-108
 Force ON of Event 4 action 7-51, 7-115

G

Group RUN/STOP function 2-20, 6-60, 6-63

H

Heat/Cool PID control 6-15, 6-18, 7-130

Heater break alarm 1 (HBA1) set value 7-34, 7-35
 Heater break alarm 1 (HBA1) type 7-51, 7-118
 Heater break alarm 2 (HBA2) set value 7-34, 7-35
 Heater break alarm 2 (HBA2) type 7-51, 7-122
 Heater break determination point 1 7-34, 7-38
 Heater break determination point 2 7-34, 7-38
 Heater melting determination point 1 7-34, 7-39
 Heater melting determination point 2 7-34, 7-39
 Hold action 7-87
 Holding peak value ambient temperature monitor
 7-54, 7-172
 Hot/Cold start 7-51, 7-123

I

Input error determination point (high) 7-49, 7-74
 Input error determination point (low) 7-49, 7-74
 Input scale high 7-49, 7-72
 Input scale low 7-49, 7-72
 Input type 7-49, 7-69
 Integral time [cool-side] 7-20, 7-27
 Integral time [heat-side] 7-20, 7-25
 Integral time adjusting factor [cool-side] 7-53, 7-156
 Integral time adjusting factor [heat-side] 7-53, 7-156
 Integral time limiter (high) [cool-side] 7-53, 7-154
 Integral time limiter (high) [heat-side] 7-53, 7-151
 Integral time limiter (low) [cool-side] 7-53, 7-154
 Integral time limiter (low) [heat-side] 7-53, 7-151
 Integral/derivative time decimal point position 7-52, 7-133
 Integrated operating time monitor 7-54, 7-171
 Integrated output limiter 7-53, 7-161
 Interlock release 7-2, 7-3, 7-13
 Interval time 1 7-34, 7-46
 Interval time 2 7-34, 7-46

L

LBA deadband 7-20, 7-23
 Link area number 7-20, 7-33
 Loader communication connector 1-10
 Loader communication 1-14

M

Manipulated output value (MV1) at STOP mode 7-52, 7-136
 Manipulated output value (MV1) monitor [heat-side]
 7-2, 7-3, 7-9
 Manipulated output value (MV2) at STOP mode 7-52, 7-136
 Manipulated output value (MV2) monitor [cool-side]
 7-2, 7-3, 7-10
 Manipulated output value at input error 7-52, 7-136
 Manipulated output value at MV transfer 7-2, 7-3, 7-11
 Manual reset 7-20, 7-30
 Master channel selection 7-51, 7-126
 Measured value (PV)/Set value (SV) monitor 7-2, 7-3, 7-5
 Memory area soak time monitor 7-2, 7-3, 7-10

Memory area transfer 7-2, 7-3, 7-11
 MV transfer function 7-51, 7-128

N

Number of heater break alarm 1 (HBA1) delay times
 7-51, 7-119
 Number of heater break alarm 2 (HBA2) delay times
 7-51, 7-122

O

ON/OFF action differential gap (lower) 7-52, 7-134
 ON/OFF action differential gap (upper) 7-52, 7-134
 Open/Close output differential gap 7-53, 7-159
 Open/Close output neutral zone 7-53, 7-158
 Output assignment 7-49, 7-79
 Output change rate limiter (down) [MV1] 7-52, 7-137
 Output change rate limiter (down) [MV2] 7-52, 7-137
 Output change rate limiter (up) [MV1] 7-52, 7-137
 Output change rate limiter (up) [MV2] 7-52, 7-137
 Output limiter high (MV1) 7-52, 7-138
 Output limiter high (MV2) 7-52, 7-138
 Output limiter low (MV1) 7-52, 7-138
 Output limiter low (MV2) 7-52, 7-138
 Output status at STOP mode 7-49, 7-82
 Output value with AT turned off 7-53, 7-149
 Output value with AT turned on 7-53, 7-149
 Overlap/Deadband 7-20, 7-29
 Overlap/Deadband reference point 7-52, 7-144

P

PID/AT transfer 6-15, 7-14, 7-15
 PID control 6-15, 6-19, 6-73
 Position proportioning control 4-7, 6-40, 7-130
 Power feed forward gain 7-52, 7-141
 Power feed forward input value monitor 7-54, 7-172
 Power feed forward selection 7-52, 7-140
 Power supply frequency 7-49, 7-76
 Proportional band [cool-side] 7-20, 7-27
 Proportional band [heat-side] 7-20, 7-24
 Proportional band adjusting factor [cool-side] 7-53, 7-156
 Proportional band adjusting factor [heat-side] 7-53, 7-156
 Proportional band limiter (high) [cool-side] 7-53, 7-153
 Proportional band limiter (high) [heat-side] 7-53, 7-150
 Proportional band limiter (low) [cool-side] 7-53, 7-153
 Proportional band limiter (low) [heat-side] 7-53, 7-150
 Proportional cycle time [cool-side] 7-34, 7-43
 Proportional cycle time [heat-side] 7-34, 7-43
 PV bias 7-34, 7-40
 PV digital filter 7-34, 7-40
 PV flashing display at input error 7-48, 7-66
 PV low input cut-off 7-34, 7-41
 PV ratio 7-34, 7-40
 PV transfer function 7-51, 7-128

R

Ratio setting function 2-2, 6-60, 6-91
Re-hold action 7-88
Remote setting (RS) input value monitor 7-2, 7-3, 7-7
Remote setting input type 7-49, 7-77
Remote/Local transfer 6-28, 7-14, 7-18
ROM version monitor 7-54, 7-171
RS bias 7-34, 7-42
RS digital filter 7-34, 7-42
RS ratio 7-34, 7-42
RUN/STOP group 7-54, 7-166
RUN/STOP transfer 6-11, 7-14, 7-18

S

Sampling cycle 7-49, 7-76
Set lock level 7-34, 7-47
Set value (SV) 7-2, 7-3, 7-7
Setting change rate limiter (down) 7-20, 7-31
Setting change rate limiter (up) 7-20, 7-31
Setting change rate limiter unit time 7-54, 7-169
Setting limiter high 7-54, 7-170
Setting limiter low 7-54, 7-170
Soak time unit 7-54, 7-169
Square root extraction 7-49, 7-75
ST derivative time adjusting factor 7-54, 7-164
ST integral time adjusting factor 7-54, 7-164
ST proportional band adjusting factor 7-54, 7-163
ST start condition 7-54, 7-163
Start determination point 7-51, 7-124
Startup tuning (ST) 6-18, 7-14, 7-16
STOP display 7-48, 7-62
SV tracking 7-51, 7-127

T

Timer 1 7-49, 7-80
Timer 2 7-49, 7-80
Timer 3 7-49, 7-80
Timer 4 7-49, 7-80
Transmission output scale high 7-50, 7-84
Transmission output scale low 7-50, 7-84
Transmission output type 7-50, 7-83

U

Undershoot suppression factor 7-52, 7-143

V

Valve action at STOP 7-53, 7-162

Character Order

* Mode

MONI: SV setting & Monitor mode

SETUP: Setup Setting mode

OPE: Operation mode

ENG: Engineering mode

PARA: Parameter Setting mode

Symbol	Name	Mode *	Page
A (A)			
<i>Add1</i>	Add1 Device address 1	SETUP	7-34, 7-44
<i>Add2</i>	Add2 Device address 2	SETUP	7-34, 7-44
<i>AHS</i>	AHS Transmission output scale high	ENG (F33)	7-50, 7-84
<i>ALC1</i>	ALC1 Alarm (ALM) lamp lighting condition 1	ENG (F30)	7-49, 7-81
<i>ALC2</i>	ALC2 Alarm (ALM) lamp lighting condition 2	ENG (F30)	7-49, 7-81
<i>ALS</i>	ALS Transmission output scale low	ENG (F33)	7-50, 7-84
<i>A-n</i>	A-M Auto/Manual transfer	OPE	6-23, 7-14, 7-17
<i>Ao</i>	Ao Transmission output type	ENG (F33)	7-50, 7-83
<i>AoVE</i>	AoVE Action (high) at input error	ENG (F51)	7-52, 7-135
<i>APT</i>	APT Memory area soak time monitor	MONI	7-2, 7-3, 7-10
<i>ArE</i>	ArE Memory area transfer	MONI	7-2, 7-3, 7-11
<i>AST</i>	AST Area soak time	PARA	7-20, 7-32
<i>ATb</i>	ATb AT bias	ENG (F52)	7-53, 7-146
<i>ATC</i>	ATC AT cycles	ENG (F52)	7-53, 7-147
<i>ATH</i>	ATH AT differential gap time	ENG (F52)	7-53, 7-148
<i>AToF</i>	AToF Output value with AT turned off	ENG (F52)	7-53, 7-149
<i>ATon</i>	ATon Output value with AT turned on	ENG (F52)	7-53, 7-149
<i>ATU</i>	ATU PID/AT transfer	OPE	6-15, 7-14, 7-15
<i>AUnE</i>	AUnE Action (low) at input error	ENG (F51)	7-52, 7-135
B (b) (b)			
<i>bit1</i>	bit1 Data bit configuration 1	SETUP	7-34, 7-45
<i>bit2</i>	bit2 Data bit configuration 2	SETUP	7-34, 7-45
<i>boS</i>	boS Burnout direction	ENG (F21)	7-49, 7-75
<i>bPS1</i>	bPS1 Communication speed 1	SETUP	7-34, 7-44
<i>bPS2</i>	bPS2 Communication speed 2	SETUP	7-34, 7-44
C (C)			
<i>CAM</i>	CAM External input type	ENG (F50)	7-51, 7-125
<i>Chr</i>	Chr Automatic temperature rise learning	OPE	6-72, 7-14, 7-17
<i>CHrd</i>	CHrd Automatic temperature rise dead time	ENG (F55)	7-54, 7-167
<i>CHrG</i>	CHrG Automatic temperature rise group	ENG (F55)	7-54, 7-165
<i>CHrT</i>	CHrT Automatic temperature rise gradient data	ENG (F55)	7-54, 7-167
<i>CMP1</i>	CMP1 Communication 1 protocol	ENG (F60)	7-54, 7-168
<i>CMP2</i>	CMP2 Communication 2 protocol	ENG (F60)	7-54, 7-168
<i>CT1</i>	CT1 Current transformer 1 (CT1) input value monitor	MONI	7-2, 7-3, 7-7
<i>CT2</i>	CT2 Current transformer 2 (CT2) input value monitor	MONI	7-2, 7-3, 7-7
<i>CTA1</i>	CTA1 CT1 assignment	ENG (F45)	7-51, 7-117
<i>CTA2</i>	CTA2 CT2 assignment	ENG (F46)	7-51, 7-121
<i>CTr1</i>	CTr1 CT1 ratio	ENG (F45)	7-51, 7-116
<i>CTr2</i>	CTr2 CT2 ratio	ENG (F46)	7-51, 7-120

Symbol	Name	Mode *	Page
D (d) (d)			
<i>d</i>	d Derivative time [heat-side]	PARA	7-20, 7-25
<i>dAJ</i>	dAJ Derivative time adjusting factor [heat-side]	ENG (F52)	7-53, 7-155
<i>db</i>	db Overlap/Deadband	PARA	7-20, 7-29
<i>dbPR</i>	dbPA Overlap/Deadband reference point	ENG (F51)	7-52, 7-144
<i>dc</i>	dc Derivative time [cool-side]	PARA	7-20, 7-28
<i>dcAJ</i>	dcAJ Derivative time adjusting factor [cool-side]	ENG (F52)	7-53, 7-155
<i>dcLH</i>	dcLH Derivative time limiter (high) [cool-side]	ENG (F52)	7-53, 7-153
<i>dcLL</i>	dcLL Derivative time limiter (low) [cool-side]	ENG (F52)	7-53, 7-153
<i>dE</i>	dE Bar graph display	ENG (F10)	7-48, 7-63
<i>dEUT</i>	dEUT Bar graph display resolution	ENG (F10)	7-48, 7-65
<i>dF</i>	dF PV digital filter	SETUP	7-34, 7-40
<i>dF2</i>	dF2 RS digital filter	SETUP	7-34, 7-42
<i>dGA</i>	dGA Derivative gain	ENG (F51)	7-52, 7-133
<i>dSL</i>	dSL Digital input (DI) assignment	ENG (F23)	7-49, 7-78
<i>dLH</i>	dLH Derivative time limiter (high) [heat-side]	ENG (F52)	7-53, 7-152
<i>dLL</i>	dLL Derivative time limiter (low) [heat-side]	ENG (F52)	7-53, 7-152
<i>dSoP</i>	dSoP PV flashing display at input error	ENG (F10)	7-48, 7-66
<i>dTP</i>	dTP Derivative term operating factor	ENG (F51)	7-52, 7-142
E (E)			
<i>EEo1</i>	EEo1 Force ON of Event 1 action	ENG (F41)	7-50, 7-93
<i>EEo2</i>	EEo2 Force ON of Event 2 action	ENG (F42)	7-50, 7-101
<i>EEo3</i>	EEo3 Force ON of Event 3 action	ENG (F43)	7-50, 7-108
<i>EEo4</i>	EEo4 Force ON of Event 4 action	ENG (F44)	7-51, 7-115
<i>EH1</i>	EH1 Event 1 differential gap	ENG (F41)	7-50, 7-90
<i>EH2</i>	EH2 Event 2 differential gap	ENG (F42)	7-50, 7-99
<i>EH3</i>	EH3 Event 3 differential gap	ENG (F43)	7-50, 7-106
<i>EH4</i>	EH4 Event 4 differential gap	ENG (F44)	7-51, 7-113
<i>EHo1</i>	EHo1 Event 1 hold action	ENG (F41)	7-50, 7-87
<i>EHo2</i>	EHo2 Event 2 hold action	ENG (F42)	7-50, 7-97
<i>EHo3</i>	EHo3 Event 3 hold action	ENG (F43)	7-50, 7-104
<i>EHo4</i>	EHo4 Event 4 hold action	ENG (F44)	7-51, 7-111
<i>EIL1</i>	EIL1 Event 1 interlock	ENG (F41)	7-50, 7-89
<i>EIL2</i>	EIL2 Event 2 interlock	ENG (F42)	7-50, 7-98
<i>EIL3</i>	EIL3 Event 3 interlock	ENG (F43)	7-50, 7-105
<i>EIL4</i>	EIL4 Event 4 interlock	ENG (F44)	7-51, 7-112
<i>ES1</i>	ES1 Event 1 type	ENG (F41)	7-50, 7-85
<i>ES2</i>	ES2 Event 2 type	ENG (F42)	7-50, 7-95
<i>ES3</i>	ES3 Event 3 type	ENG (F43)	7-50, 7-102
<i>ES4</i>	ES4 Event 4 type	ENG (F44)	7-51, 7-109

Symbol	Name	Mode *	Page
<i>EY1</i>	EV1 Event 1 set value (EV1)	PARA	7-20, 7-21
<i>EY2</i>	EV2 Event 2 set value (EV2)	PARA	7-20, 7-21
<i>EY3</i>	EV3 Event 3 set value (EV3)	PARA	7-20, 7-21
<i>EY4</i>	EV4 Event 4 set value (EV4)	PARA	7-20, 7-21
<i>EYn1</i>	EVM1 Event monitor 1	MONI	7-2, 7-3, 7-8
<i>EYn2</i>	EVM2 Event monitor 2	MONI	7-2, 7-3, 7-8
<i>EYΓ1</i>	EVT1 Event 1 delay timer	ENG (F41)	7-50, 7-91
<i>EYΓ2</i>	EVT2 Event 2 delay timer	ENG (F42)	7-50, 7-100
<i>EYΓ3</i>	EVT3 Event 3 delay timer	ENG (F43)	7-50, 7-107
<i>EYΓ4</i>	EVT4 Event 4 delay timer	ENG (F44)	7-51, 7-114
<i>EYΣ</i>	EXC Energized/De-energized	ENG (F30)	7-49, 7-80
F (F)			
<i>F_n</i>	Fn Direct key type	ENG (F11)	7-48, 7-68
<i>F_{n1}</i>	Fn1 Direct key 1	ENG (F11)	7-48, 7-67
<i>F_{n2}</i>	Fn2 Direct key 2	ENG (F11)	7-48, 7-67
<i>F_{n3}</i>	Fn3 Direct key 3	ENG (F11)	7-48, 7-68
H (H)			
<i>HbA1</i>	HbA1 Heater break alarm 1 (HBA1) set value	SETUP	7-34, 7-35
<i>HbA2</i>	HbA2 Heater break alarm 2 (HBA2) set value	SETUP	7-34, 7-35
<i>HbC1</i>	HbC1 Number of heater break alarm 1 (HBA1) delay times	ENG (F45)	7-51, 7-119
<i>HbC2</i>	HbC2 Number of heater break alarm 2 (HBA2) delay times	ENG (F46)	7-51, 7-122
<i>HbH1</i>	HbH1 Heater melting determination point 1	SETUP	7-34, 7-39
<i>HbH2</i>	HbH2 Heater melting determination point 2	SETUP	7-34, 7-39
<i>HbL1</i>	HbL1 Heater break determination point 1	SETUP	7-34, 7-38
<i>HbL2</i>	HbL2 Heater break determination point 2	SETUP	7-34, 7-38
<i>HbS1</i>	HbS1 Heater break alarm 1 (HBA1) type	ENG (F45)	7-51, 7-117
<i>HbS2</i>	HbS2 Heater break alarm 2 (HBA2) type	ENG (F46)	7-51, 7-122
<i>HEAT</i>	HEAT Power feed forward input value monitor	ENG (F91)	7-54, 7-172
I (I)			
<i>I</i>	I Integral time [heat-side]	PARA	7-20, 7-25
<i>IAJ</i>	IAJ Integral time adjusting factor [heat-side]	ENG (F52)	7-53, 7-156
<i>Ic</i>	Ic Integral time [cool-side]	PARA	7-20, 7-27
<i>IcAJ</i>	IcAJ Integral time adjusting factor [cool-side]	ENG (F52)	7-53, 7-156
<i>IcLH</i>	IcLH Integral time limiter (high) [cool-side]	ENG (F52)	7-53, 7-154
<i>IcLL</i>	IcLL Integral time limiter (low) [cool-side]	ENG (F52)	7-53, 7-154
<i>IdDP</i>	IdDP Integral/derivative time decimal point position	ENG (F51)	7-52, 7-133
<i>ILH</i>	ILH Integral time limiter (high) [heat-side]	ENG (F52)	7-53, 7-151
<i>ILL</i>	ILL Integral time limiter (low) [heat-side]	ENG (F52)	7-53, 7-151
<i>ILr</i>	ILr Interlock release	MONI	7-2, 7-3, 7-13
<i>InP</i>	InP Input type	ENG (F21)	7-49, 7-69
<i>InT1</i>	InT1 Interval time 1	SETUP	7-34, 7-46
<i>InT2</i>	InT2 Interval time 2	SETUP	7-34, 7-46

Symbol	Name	Mode *	Page
L (L)			
<i>LbA</i>	LbA Control loop break alarm (LBA) time	PARA	7-20, 7-22
<i>Lbd</i>	Lbd LBA deadband	PARA	7-20, 7-23
<i>LCK</i>	LCK Set lock level	SETUP	7-34, 7-47
<i>LnKA</i>	LnKA Link area number	PARA	7-20, 7-33
<i>LoGC</i>	LoGC Output assignment	ENG (F30)	7-49, 7-79
M (M)			
<i>MCH</i>	MCH Master channel selection	ENG (F50)	7-51, 7-126
<i>MoT</i>	MoT Control motor time	ENG (F53)	7-53, 7-161
<i>Mr</i>	Mr Manual reset	PARA	7-20, 7-30
<i>MV</i>	MV Manipulated output value (MV1) monitor [heat-side]	MONI	7-2, 7-3, 7-9
<i>MV2</i>	MV2 Manipulated output value (MV2) monitor [cool-side]	MONI	7-2, 7-3, 7-10
<i>MVTS</i>	MVTS MV transfer function	ENG (F50)	7-51, 7-128
O (o) (o)			
<i>oHH</i>	oHH ON/OFF action differential gap (upper)	ENG (F51)	7-52, 7-134
<i>oHL</i>	oHL ON/OFF action differential gap (lower)	ENG (F51)	7-52, 7-134
<i>oLA</i>	oLA Integrated output limiter	ENG (F53)	7-53, 7-161
<i>oLH</i>	oLH Output limiter high (MV1)	ENG (F51)	7-52, 7-138
<i>oLH2</i>	oLH2 Output limiter high (MV2)	ENG (F51)	7-52, 7-138
<i>oLL</i>	oLL Output limiter low (MV1)	ENG (F51)	7-52, 7-138
<i>oLL2</i>	oLL2 Output limiter low (MV2)	ENG (F51)	7-52, 7-138
<i>ord</i>	ord Output change rate limiter (down) [MV1]	ENG (F51)	7-52, 7-137
<i>ord2</i>	ord2 Output change rate limiter (down) [MV2]	ENG (F51)	7-52, 7-137
<i>orU</i>	orU Output change rate limiter (up) [MV1]	ENG (F51)	7-52, 7-137
<i>orU2</i>	orU2 Output change rate limiter (up) [MV2]	ENG (F51)	7-52, 7-137
<i>oS</i>	oS Control action	ENG (F51)	7-52, 7-129
<i>oTT1</i>	oTT1 Timer 1	ENG (F30)	7-49, 7-80
<i>oTT2</i>	oTT2 Timer 2	ENG (F30)	7-49, 7-80
<i>oTT3</i>	oTT3 Timer 3	ENG (F30)	7-49, 7-80
<i>oTT4</i>	oTT4 Timer 4	ENG (F30)	7-49, 7-80
P (P)			
<i>P</i>	P Proportional band [heat-side]	PARA	7-20, 7-24
<i>PAJ</i>	PAJ Proportional band adjusting factor [heat-side]	ENG (F52)	7-53, 7-156
<i>Pb</i>	Pb PV bias	SETUP	7-34, 7-40
<i>Pc</i>	Pc Proportional band [cool-side]	PARA	7-20, 7-27
<i>PcAJ</i>	PcAJ Proportional band adjusting factor [cool-side]	ENG (F52)	7-53, 7-156
<i>PcLH</i>	PcLH Proportional band limiter (high) [cool-side]	ENG (F52)	7-53, 7-153
<i>PcLL</i>	PcLL Proportional band limiter (low) [cool-side]	ENG (F52)	7-53, 7-153
<i>Pd</i>	Pd Hot/Cold start	ENG (F50)	7-51, 7-123
<i>PdA</i>	PdA Start determination point	ENG (F50)	7-51, 7-124
<i>PFF</i>	PFF Power feed forward selection	ENG (F51)	7-52, 7-140
<i>PFFS</i>	PFFS Power feed forward gain	ENG (F51)	7-52, 7-141

Symbol	Name	Mode *	Page
$PFrq$	Power supply frequency	ENG (F21)	7-49, 7-76
$PGdP$	Decimal point position	ENG (F21)	7-49, 7-71
$PGSH$	Input scale high	ENG (F21)	7-49, 7-72
$PGSL$	Input scale low	ENG (F21)	7-49, 7-72
PLC	PV low input cut-off	SETUP	7-34, 7-41
PLH	Proportional band limiter (high) [heat-side]	ENG (F52)	7-53, 7-150
PLL	Proportional band limiter (low) [heat-side]	ENG (F52)	7-53, 7-150
PoS	Feedback adjustment	ENG (F53)	7-53, 7-160
PoV	Input error determination point (high)	ENG (F21)	7-49, 7-74
Pr	PV ratio	SETUP	7-34, 7-40
PSn	Manipulated output value at input error	ENG (F51)	7-52, 7-136
PSn'	Manipulated output value at MV transfer	MONI	7-2, 7-3, 7-11
PUn	Input error determination point (low)	ENG (F21)	7-49, 7-74
$PVTS$	PV transfer function	ENG (F50)	7-51, 7-128
R (r) (r)			
rb	RS bias	SETUP	7-34, 7-42
$rInP$	Remote setting input type	ENG (F22)	7-49, 7-77
$r-L$	Remote/Local transfer	OPE	6-28, 7-14, 7-18
$rMV1$	Manipulated output value (MV1) at STOP mode	ENG (F51)	7-52, 7-136
$rMV2$	Manipulated output value (MV2) at STOP mode	ENG (F51)	7-52, 7-136
rPT	Control response parameter	PARAM	7-20, 7-26
rr	RS ratio	SETUP	7-34, 7-42
$r-S$	RUN/STOP transfer	OPE	6-11, 7-14, 7-18
rSG	RUN/STOP group	ENG (F55)	7-54, 7-166
S (S)			
SLH	Setting limiter high	ENG (F71)	7-54, 7-170
SLL	Setting limiter low	ENG (F71)	7-54, 7-170
SMP	Sampling cycle	ENG (F21)	7-49, 7-76
$SPCH$	STOP display	ENG (F10)	7-48, 7-62
Sqr	Square root extraction	ENG (F21)	7-49, 7-75
SS	Output status at STOP mode	ENG (F30)	7-49, 7-82
$STdK$	ST derivative time adjusting factor	ENG (F54)	7-54, 7-164
$STdP$	Soak time unit	ENG (F70)	7-54, 7-169
$STIK$	ST integral time adjusting factor	ENG (F54)	7-54, 7-164
$STPK$	ST proportional band adjusting factor	ENG (F54)	7-54, 7-163
STS	ST start condition	ENG (F54)	7-54, 7-163
STU	Startup tuning (ST)	OPE	6-18, 7-14, 7-16
SV	Set value (SV)	MONI	7-2, 7-3, 7-7
SVr	Remote setting (RS) input value monitor	MONI	7-2, 7-3, 7-7
$SVrd$	Setting change rate limiter (down)	PARAM	7-20, 7-31
$SVrT$	Setting change rate limiter unit time	ENG (F70)	7-54, 7-169
$SVrU$	Setting change rate limiter (up)	PARAM	7-20, 7-31

Symbol	Name	Mode *	Page
T (t) (T, t)			
t	Proportional cycle time [cool-side]	SETUP	7-34, 7-43
T	Proportional cycle time [heat-side]	SETUP	7-34, 7-43
TCJ	Holding peak value ambient temperature monitor	ENG (F91)	7-54, 7-172
Trk	SV tracking	ENG (F50)	7-51, 7-127
U (U)			
$UniT$	Display unit	ENG (F21)	7-49, 7-71
US	Undershoot suppression factor	ENG (F51)	7-52, 7-143
V (V)			
VAL	Valve action at STOP	ENG (F53)	7-53, 7-162
W (W)			
WT	Integrated operating time monitor	ENG (F91)	7-54, 7-171
Y (Y)			
$YASo$	Action at saturated output	ENG (F53)	7-53, 7-162
Ybr	Action at feedback resistance (FBR) input error	ENG (F53)	7-53, 7-159
Ydb	Open/Close output neutral zone	ENG (F53)	7-53, 7-158
YHS	Open/Close output differential gap	ENG (F53)	7-53, 7-159

Revisions

Date of Revision	Manual Number	Reason for Revision
April, 2005	IMR01W03-E1	The first edition issue
August, 2005	IMR01W03-E2	<p>Addition of description:</p> <p>Automatic power frequency detection function by CT input P. 1-12, P. 7-75, P. 9-4</p> <p>Correspondence of startup tuning to Heat/Cool control P. 6-18, P. 6-19, P. 7-16</p> <p>Correspondence of automatic temperature rise learning function to Heat/Cool control P. 6-73, P. 6-74, P. 7-17</p> <p>Setting example of bar graph display resolution P. 7-65</p> <p>Hot/Cold start action change P. 6-39</p> <p>Description of action (high/low) at input error P. 7-135</p> <p>Factory set value change:</p> <p>Start determination point P. 7-124, P. A-18</p> <p>Open/Close output neutral zone P. 7-156, P. A-21</p> <p>Open/Close output differential gap P. 7-157, P. A-21</p> <p>Revision of clerical errors:</p> <p>“Output value when power failure recovers” at Hot start 2 in Auto mode P. 6-39, P. 7-123</p>
September, 2008	IMR01W03-E3	Overall revision
July, 2009	IMR01W03-E4	<p>Addition of description:</p> <p>Direct action of Position proportioning PID control P. 1-4, P. 7-58, P. 7-129, P. A-20</p> <p>Overlap/Deadband reference point P. 7-52, P. 7-144, P. 9-9, P. A-21</p> <p>Action at saturated output P. 6-40, P. 6-41, P. 6-43, P. 6-46, P. 6-47, P. 7-53, P. 7-131, P. 7-162, P. 9-11, P. A-22</p> <p>Exception of key operation P. 5-2, P. 6-48, P. 7-54, P. 7-160, P. 7-172</p> <p>Change of description:</p> <p>State of STOP mode P. 6-11</p> <p>Factory set value change:</p> <p>Heater break alarm 1 (HBA1) type P. 7-37, P. 7-117, P. 7-122, P. A-19</p>
	IMR01W03-E5	Intentionally unused (This version number is not used in English version to match the versions between Japanese and English versions.)
December, 2010	IMR01W03-E6	Revised due to change of terminal cover shape and model code as well as corrections of errors.
August, 2012	IMR01W03-E7	<p>Updated for the latest version of the OS: P. 1-2, P. 1-15</p> <p>Added Communication tool PROTEM2: P. 1-15</p> <p>Added comment to Termination resistor: P. 4-13</p> <p>Changed the data range of "Manipulated output value at MV transfer" in Heat/Cool PID control: P. 7-11, P. 9-9, P. A-10</p> <p>Added comment to Force ON of Event 4 action: P. 7-115</p>

MEMO



RKC INSTRUMENT INC.

HEADQUARTERS: 16-6, KUGAHARA 5-CHOME, OHTA-KU TOKYO 146-8515 JAPAN

PHONE: 03-3751-9799 (+81 3 3751 9799)

FAX: 03-3751-8585 (+81 3 3751 8585)

E-mail: info@rkcinst.co.jp

Website: <http://www.rkcinst.com/>